

**- CATALOGUE TECHNIQUE -
TOUS MATERIAUX**



Thermobloc

hilzinger 

Fabricant de Fenêtres et Portes.

1. MISE EN OEUVRE THERMOBLOC - ALU

1.1 - THERMADVANCE

1.1.1 - Applique rattrapage d'isolation ISO 100	1 - 4
1.1.2 - Applique rattrapage d'isolation ISO 120	5 - 8
1.1.3 - Applique rattrapage d'isolation ISO 140	9 - 12
1.1.4 - Applique rattrapage d'isolation ISO 160	13 - 16
1.1.5 - Applique rattrapage d'isolation ISO 180	17 - 20
1.1.6 - Applique rattrapage d'isolation ISO 200	21 - 24
1.1.7 - Pose en tunnel (dormant 5292)	25 - 26
1.1.8 - Pose en tunnel (dormant 5473)	27 - 28
1.1.9 - Rénovation (dormant 5460)	29 - 30
1.1.10 - Rénovation (dormant 5485)	31 - 32

1.2 - COULISSANTS ALU

1.2.1 - Applique rattrapage d'isolation ISO 120 (2 rails - coupe droite)	33 - 35
1.2.2 - Applique rattrapage d'isolation ISO 140 (2 rails - coupe droite)	36 - 38
1.2.3 - Applique rattrapage d'isolation ISO 160 (2 rails - coupe droite)	39 - 41
1.2.4 - Applique rattrapage d'isolation ISO 180 (2 rails - coupe droite)	42 - 44
1.2.5 - Applique rattrapage d'isolation ISO 180 (3 rails - coupe droite)	45 - 46
1.2.6 - Applique rattrapage d'isolation ISO 200 (2 rails - coupe droite)	47 - 49
1.2.7 - Applique rattrapage d'isolation ISO 200 (3 rails - coupe droite)	50 - 51
1.2.8 - Applique rattrapage d'isolation ISO 120 (2 rails - coupe d'onglet)	52 - 54
1.2.9 - Applique rattrapage d'isolation ISO 140 (2 rails - coupe d'onglet)	55 - 57
1.2.10 - Applique rattrapage d'isolation ISO 160 (2 rails - coupe d'onglet)	58 - 60
1.2.11 - Applique rattrapage d'isolation ISO 180 (2 rails - coupe d'onglet)	61 - 63
1.2.12 - Applique rattrapage d'isolation ISO 180 (3 rails - coupe d'onglet)	64 - 65
1.2.13 - Applique rattrapage d'isolation ISO 200 (2 rails - coupe d'onglet)	66 - 68
1.2.14 - Applique rattrapage d'isolation ISO 200 (3 rails - coupe d'onglet)	69 - 70
1.2.15 - Applique ISO 220 (4 vantaux / 4 rails)	71 - 72
1.2.16 - Pose en tunnel (2 rails)	73 - 75
1.2.17 - Pose en tunnel (3 rails)	76 - 77
1.2.18 - Pose en tunnel (4 rails)	78 - 79

1.3 - COULISSANTS A GALANDAGE

1.3.1 - Coulissant à galandage (1 rail)	80 - 81
1.3.2 - Coulissant à galandage (2 rails)	82 - 83
1.3.3 - Coulisses Aluminium	84
1.3.4 - Coulissant à galandage SVR (1 rail)	85 - 86
1.3.5 - Coulissant à galandage SVR (2 rails)	87 - 88

2. MISE EN OEUVRE THERMOBLOC - PVC

2.1 - MASTER / TENDANCE 70

2.1.1 - Applique rattrapage d'isolation ISO 100	89 - 94
2.1.2 - Applique rattrapage d'isolation ISO 120	95 - 100
2.1.3 - Applique rattrapage d'isolation ISO 140	101 - 106
2.1.4 - Applique rattrapage d'isolation ISO 160	107 - 110
2.1.5 - Pose en tunnel	111 - 115
2.1.6 - Rénovation	116 - 121

2.2 - ZENIT 76

2.2.1 - Applique rattrapage d'isolation ISO 100	122 - 125
2.2.2 - Applique rattrapage d'isolation ISO 120	126 - 129
2.2.3 - Applique rattrapage d'isolation ISO 140	130 - 133
2.2.4 - Applique rattrapage d'isolation ISO 160	134 - 137
2.2.5 - Pose en tunnel	138 - 147
2.2.6 - Pose en feuillure	148 - 150
2.2.6 - Rénovation	151 - 154

2.2 - COULISSANTS LEVANTS

2.3.1 - Applique rattrapage d'isolation ISO 100	155 - 156
2.3.2 - Applique rattrapage d'isolation ISO 120	157 - 158
2.3.3 - Applique rattrapage d'isolation ISO 140	159 - 160
2.3.4 - Applique rattrapage d'isolation ISO 160	161 - 162
2.3.5 - Pose en tunnel	163 - 164
2.3.6 - Pose en tunnel (Softline)	165 - 166
2.3.6 - Pose en tunnel (Quinline)	167 - 168
2.3.7 - Coulisses PVC	169

3. MISE EN OEUVRE THERMOBLOC - BOIS/BOIS-ALU

3.1 - BOIS

3.1.1 - Applique rattrapage d'isolation ISO 100	170 - 173
3.1.2 - Applique rattrapage d'isolation ISO 120	174 - 177
3.1.3 - Applique rattrapage d'isolation ISO 140	178 - 181
3.1.4 - Applique rattrapage d'isolation ISO 160	182 - 185
3.1.5 - Pose en tunnel	186 - 187

3.2 - BOIS-ALU

3.2.1 - Applique rattrapage d'isolation ISO 120	188 - 191
3.2.2 - Applique rattrapage d'isolation ISO 140	192 - 195
3.2.3 - Applique rattrapage d'isolation ISO 160	196 - 199
3.2.4 - Pose en tunnel	200 - 201

3.3 - COULISSANTS LEVANTS BOIS ET BOIS-ALU

3.3.1 - Coulissants levants bois	202 - 203
3.3.2 - Coulissants levants bois-alu	204 - 205

3.4 - COUPES HORIZONTALES BOIS AVEC COULISSES RÉNOVATION R40

3.4.1 - Coulisses Alu	206
3.4.2 - Applique ou Feuillure ISO 100 avec coulisses R40	207
3.4.3 - Applique ou Feuillure ISO 120 avec coulisses R40	208
3.4.4 - Applique ou Feuillure ISO 140 avec coulisses R40	209
3.4.5 - Applique ou Feuillure ISO 160 avec coulisses R40	210
3.4.6 - Pose en tunnel avec coulisses R40	211

1

**Mise en Oeuvre
Thermobloc - ALU**

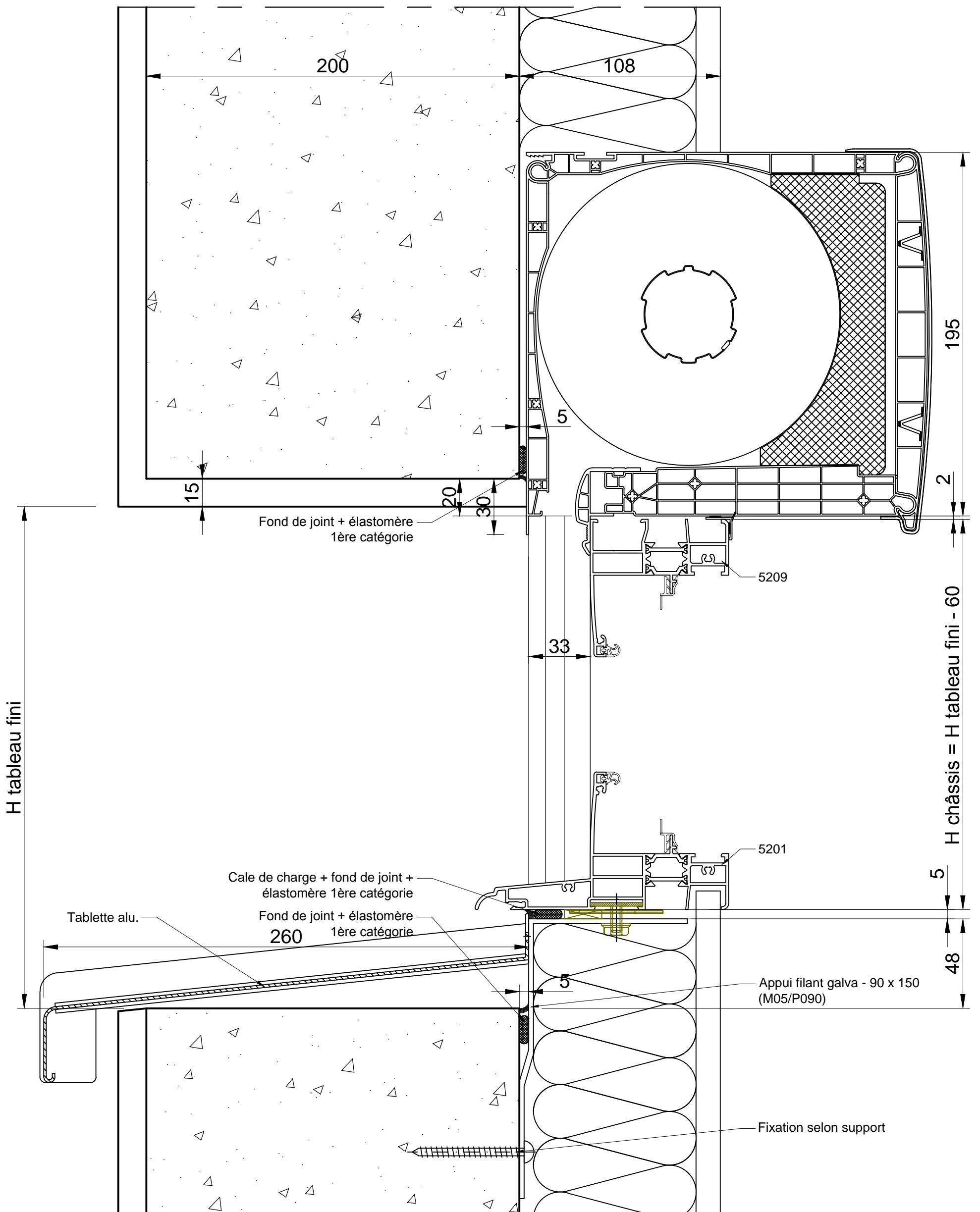

CATA TECH	Dessiné par E. TAVARES	Approuvé par N. BUERMANN	Coupe Verticale	Modifié le 11/02/2020	Date 28/11/2018	Echelle 1/2 - A3
 Fabricant de Fenêtres et Portes.			APPLIQUE RATTRAPAGE ISO 100			
			MISE EN OEUVRE			Edition C

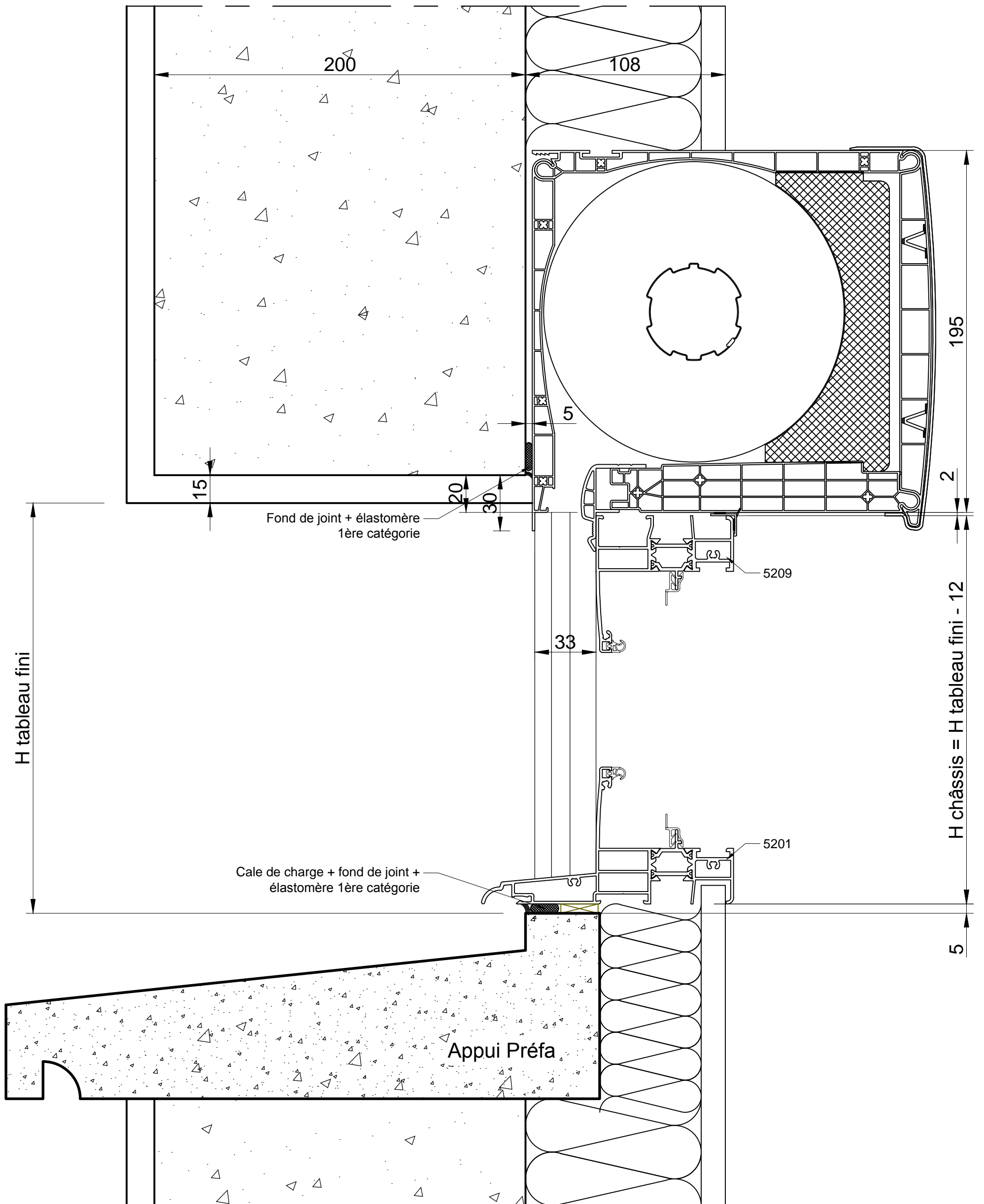

CATA TECH	Dessiné par E. TAVARES	Approuvé par N. BUERMANN	Coupe Verticale	Modifié le 11/02/2020	Date 28/11/2018	Echelle 1/2 - A3
 Fabricant de Fenêtres et Portes.			APPLIQUE RATTRAPAGE ISO 100			
			MISE EN OEUVRE			Edition C

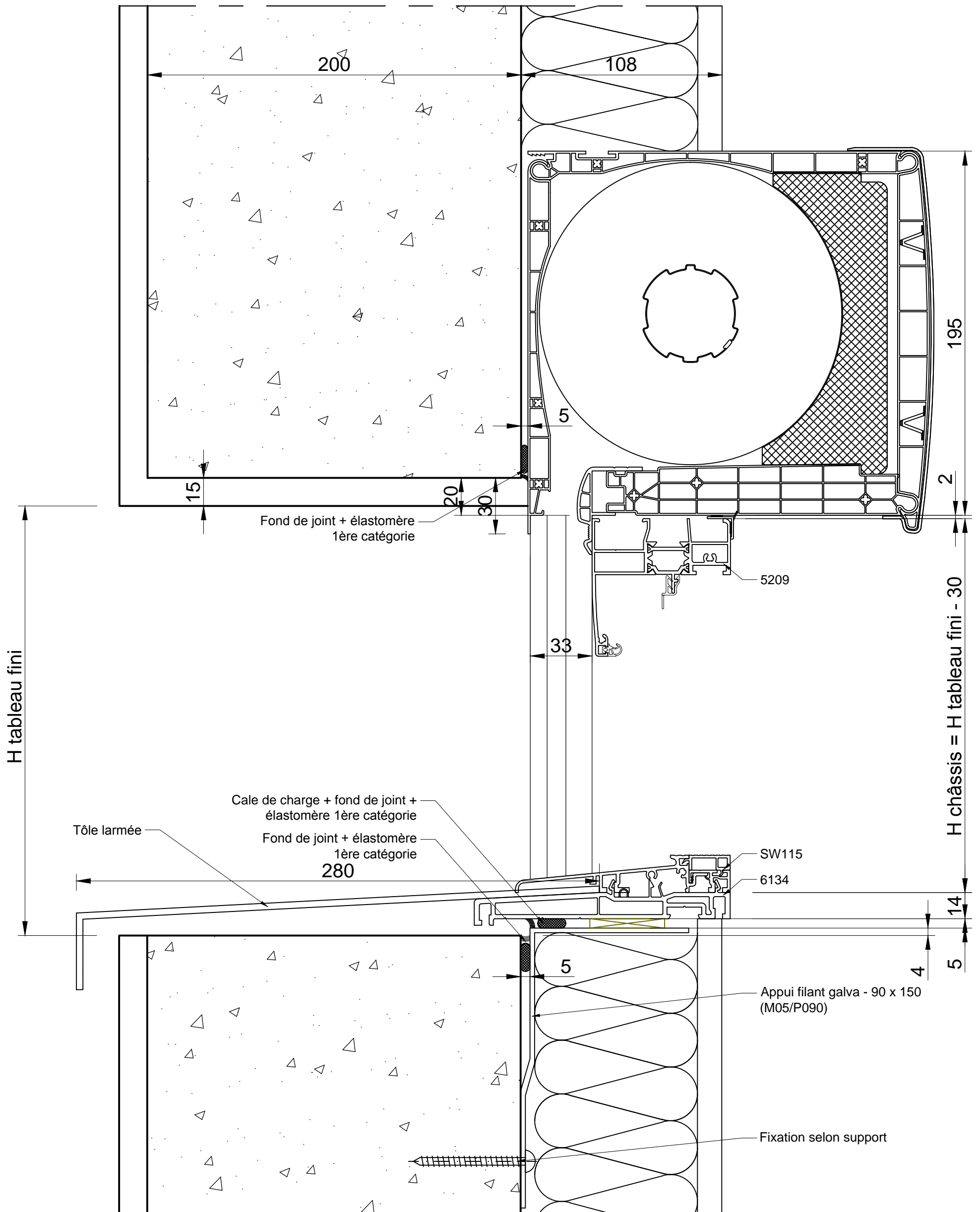

CATA TECH	Dessiné par E. TAVARES	Approuvé par N. BUERMANN	Coupe Verticale	Modifié le 11/02/2020	Date 28/11/2018	Echelle 1/2 - A3
 Fabricant de Fenêtres et Portes.			APPLIQUE RATTRAPAGE ISO 100			
			MISE EN OEUVRE			Edition C

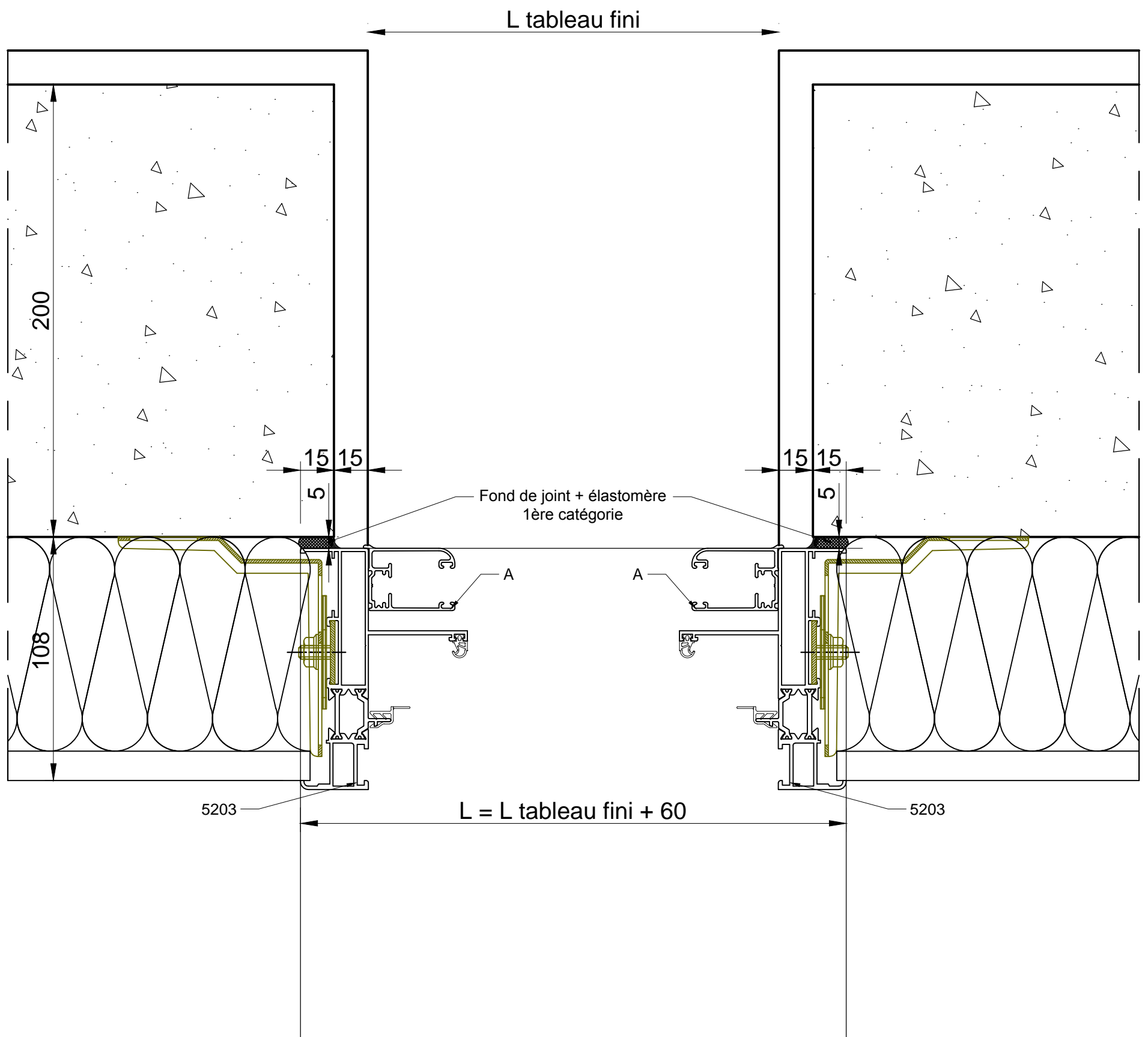

CATA TECH	Dessiné par E. TAVARES	Approuvé par N. BUERMANN	Coupe Horizontale	Modifié le 11/02/2020	Date 28/11/2018	Echelle 1/2 - A3
 Fabricant de Fenêtres et Portes.			APPLIQUE RATRAPAGE ISO 100			
			MISE EN OEUVRE			Edition C

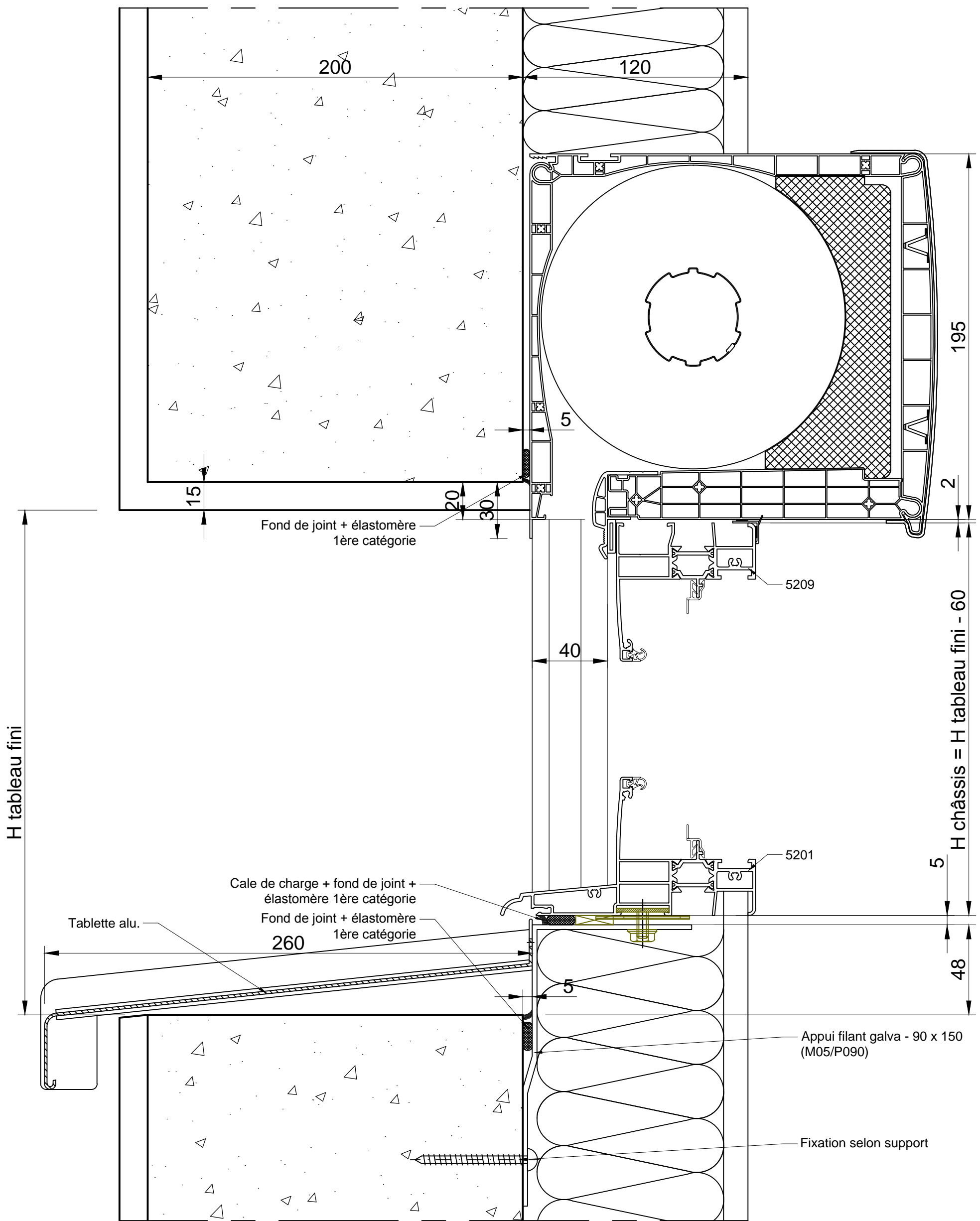

CATA TECH	Dessiné par E. TAVARES	Approuvé par N. BUERMANN	Coupe Verticale	Modifié le 11/02/2020	Date 28/11/2018	Echelle 1/2 - A3
 <p>hilzinger Fabricant de Fenêtres et Portes.</p>			APPLIQUE RATRAPAGE ISO 120			
			MISE EN OEUVRE			Edition C

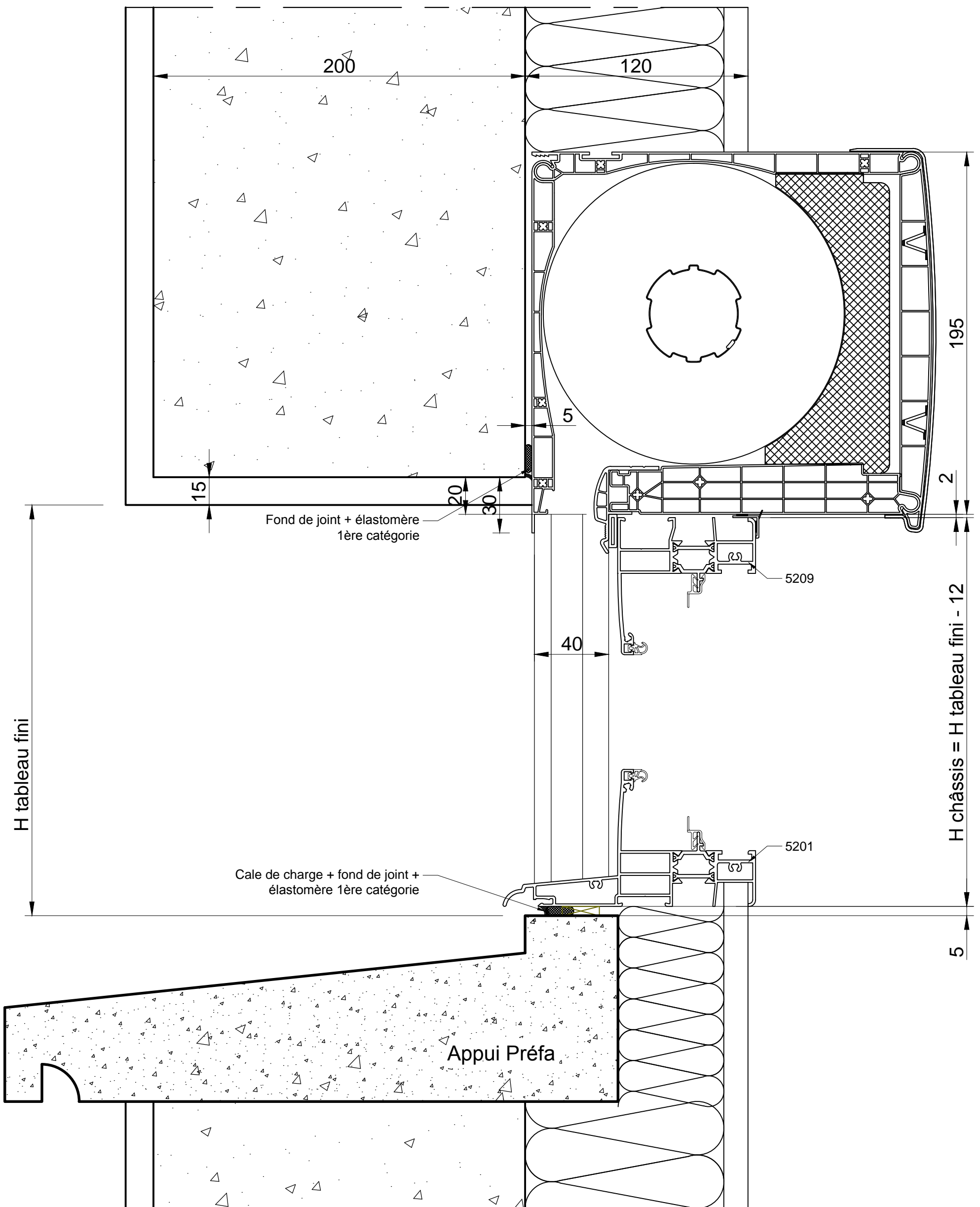

CATA TECH	Dessiné par E. TAVARES	Approuvé par N. BUERMANN	Coupe Verticale	Modifié le 11/02/2020	Date 28/11/2018	Echelle 1/2 - A3
 Fabricant de Fenêtres et Portes.			APPLIQUE RATRAPAGE ISO 120			
			MISE EN OEUVRE			Edition C

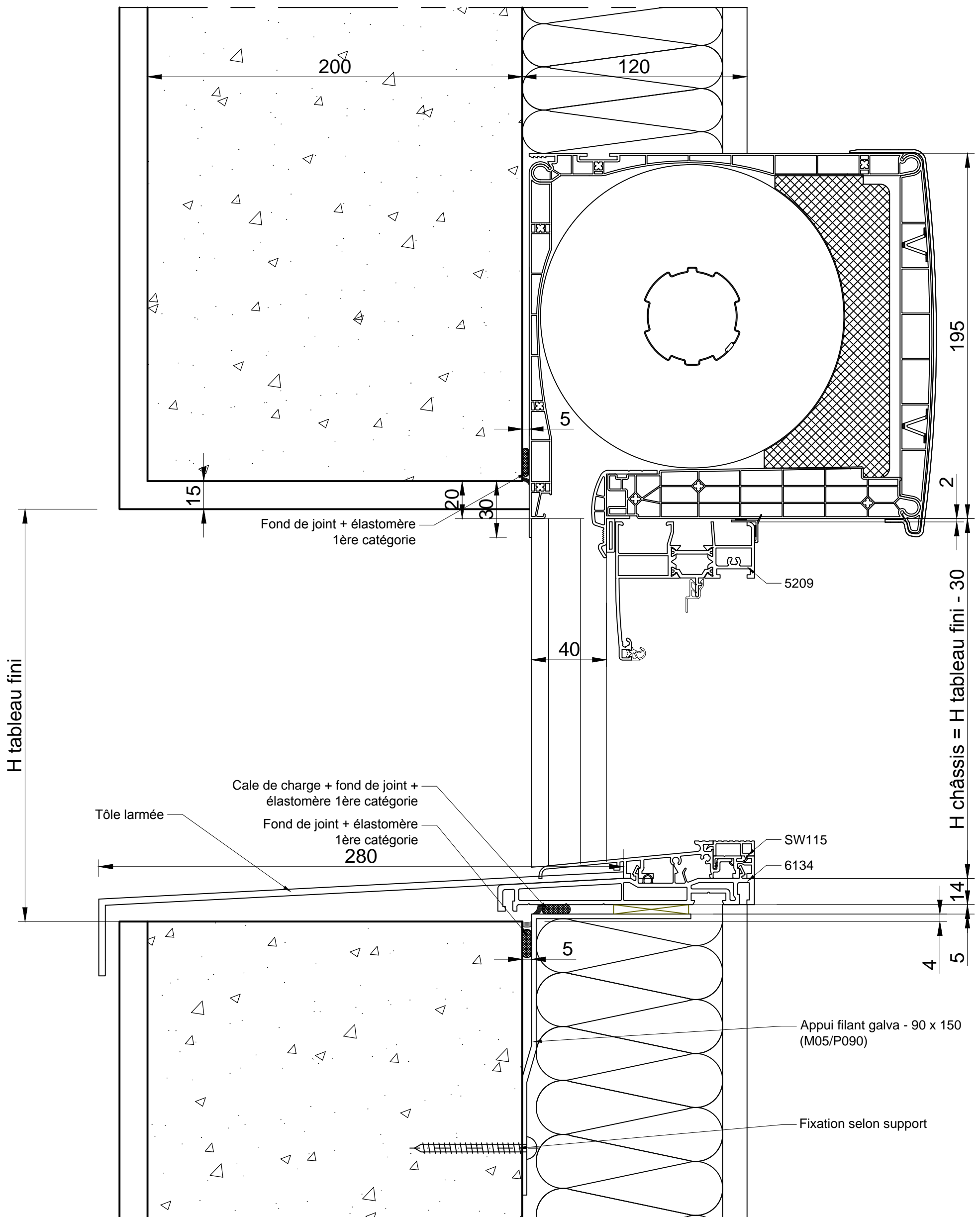

CATA TECH	Dessiné par E. TAVARES	Approuvé par N. BUERMANN	Coupe Verticale	Modifié le 11/02/2020	Date 28/11/2018	Echelle 1/2 - A3
 Fabricant de Fenêtres et Portes.			APPLIQUE RATTRAPAGE ISO 120			
			MISE EN OEUVRE		Edition C	Feuille No. ALU 7

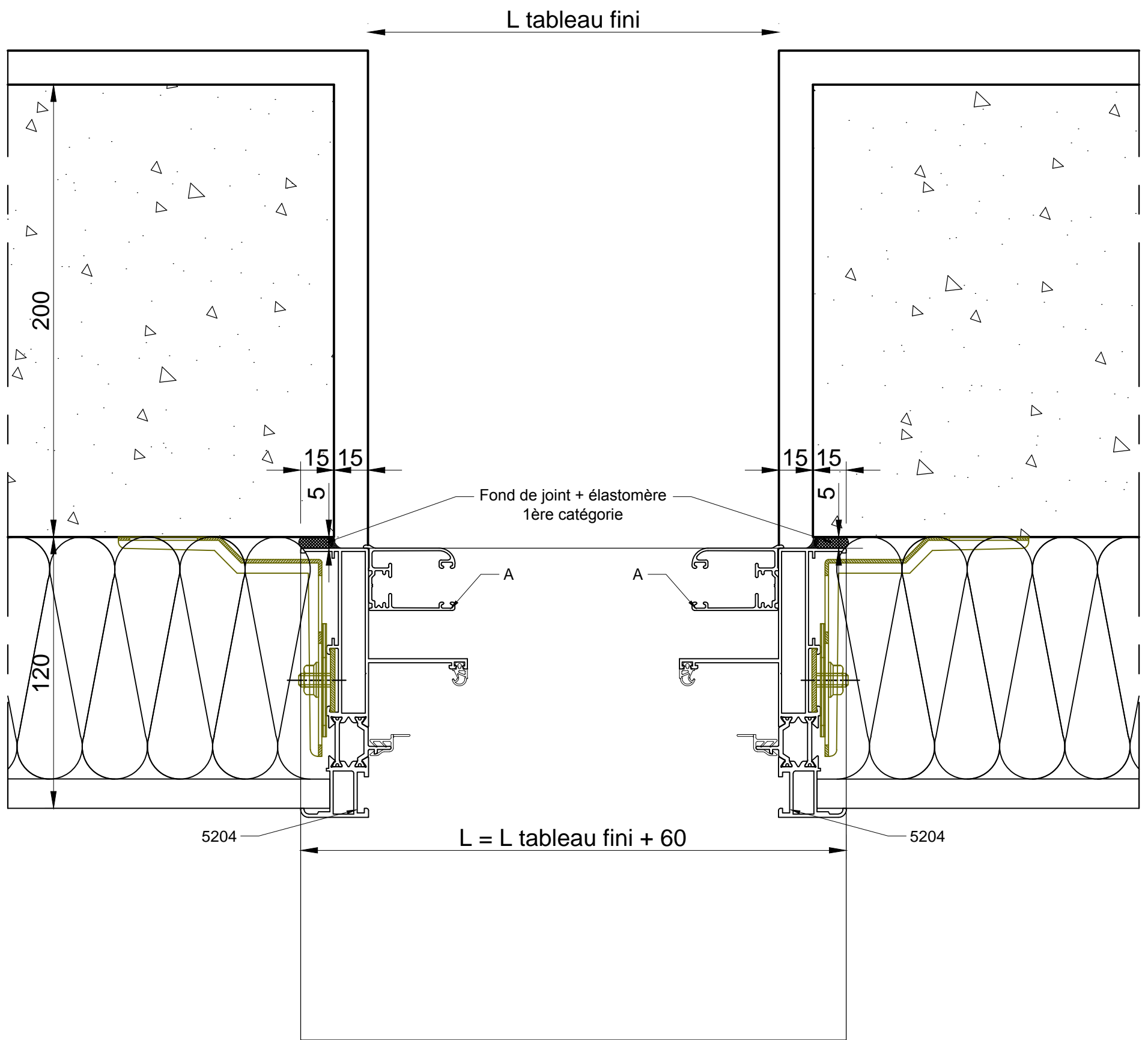

CATA TECH	Dessiné par E. TAVARES	Approuvé par N. BUERMANN	Coupe Horizontale	Modifié le 11/02/2020	Date 28/11/2018	Echelle 1/2 - A3
 Fabricant de Fenêtres et Portes.			APPLIQUE RATRAPAGE ISO 120			
			MISE EN OEUVRE			Edition C

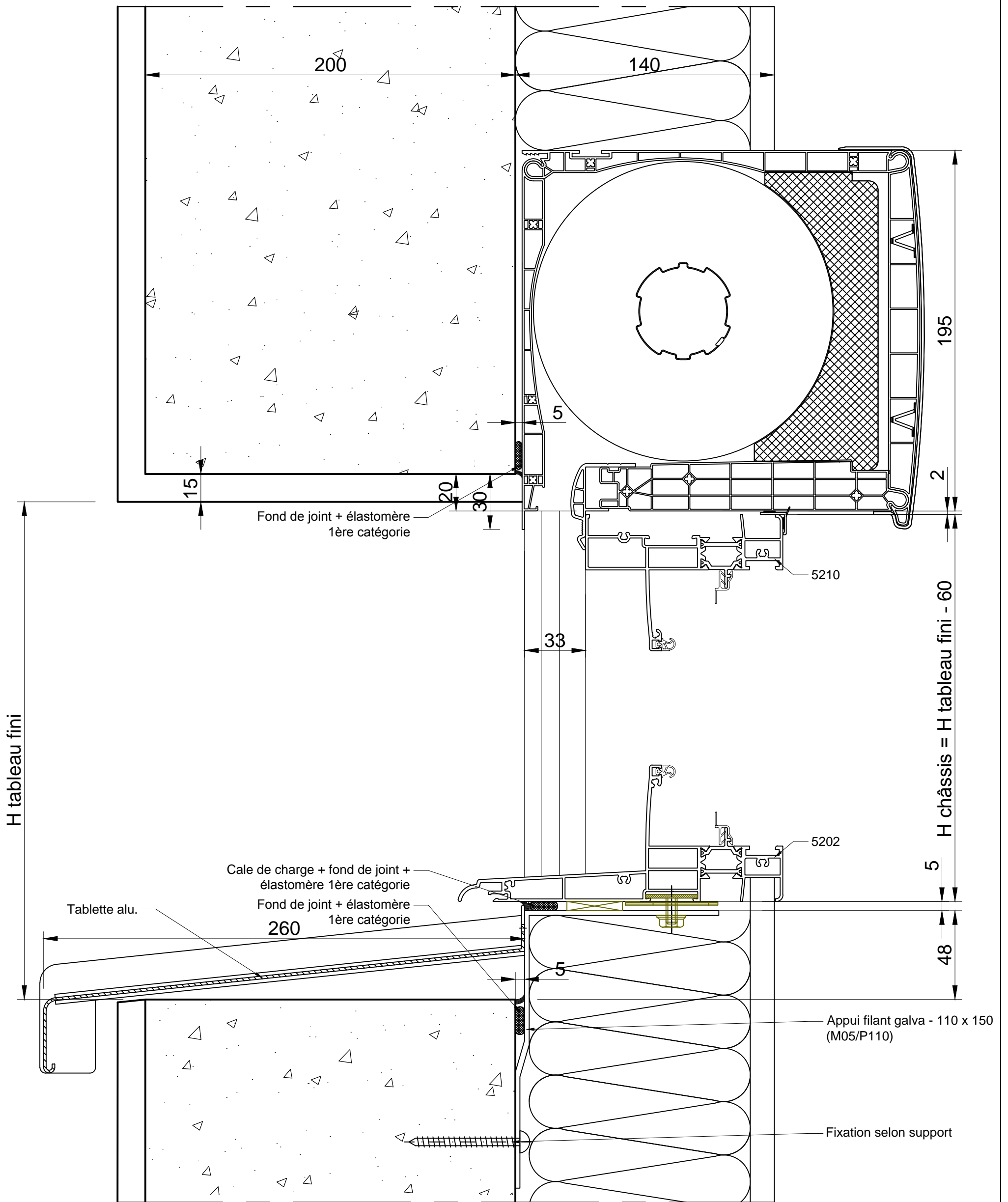

CATA TECH	Dessiné par E. TAVARES	Approuvé par N. BUERMANN	Coupe Verticale	Modifié le 11/02/2020	Date 28/11/2018	Echelle 1/2 - A3
 Fabricant de Fenêtres et Portes.			APPLIQUE RATTRAPAGE ISO 140			
			MISE EN OEUVRE	Edition C	Feuille No. ALU 9	

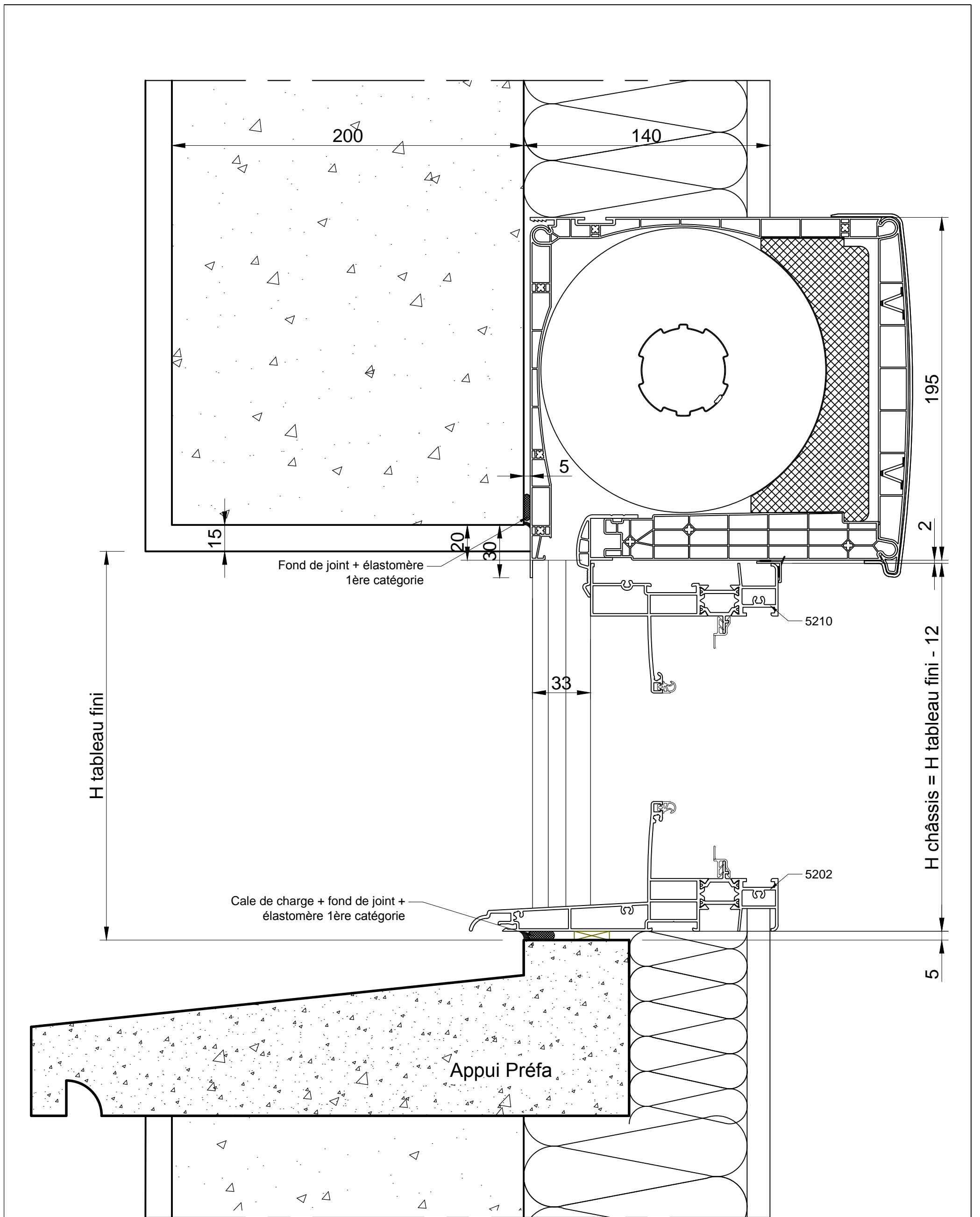

CATA TECH	Dessiné par E. TAVARES	Approuvé par N. BUERMANN	Coupe Verticale	Modifié le 11/02/2020	Date 28/11/2018	Echelle 1/2 - A3
 <p>hilzinger Fabricant de Fenêtres et Portes.</p>			APPLIQUE RATTRAPAGE ISO 140			
			MISE EN OEUVRE			Edition C

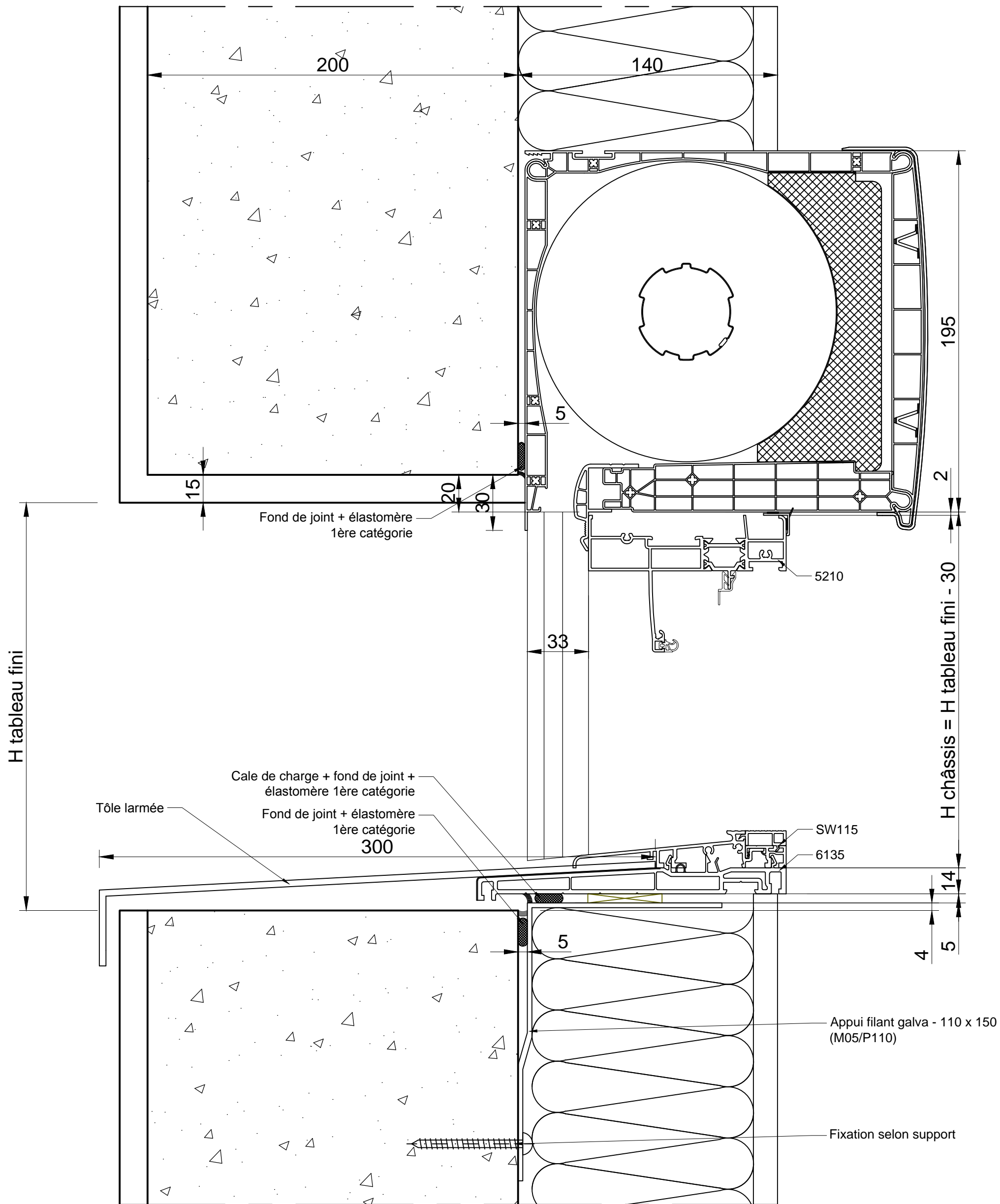

CATA TECH	Dessiné par E. TAVARES	Approuvé par N. BUERMANN	Coupe Verticale	Modifié le 11/02/2020	Date 28/11/2018	Echelle 1/2 - A3
 Fabricant de Fenêtres et Portes.			APPLIQUE RATTRAPAGE ISO 140			
			MISE EN OEUVRE		Edition C	Feuille No. ALU 11

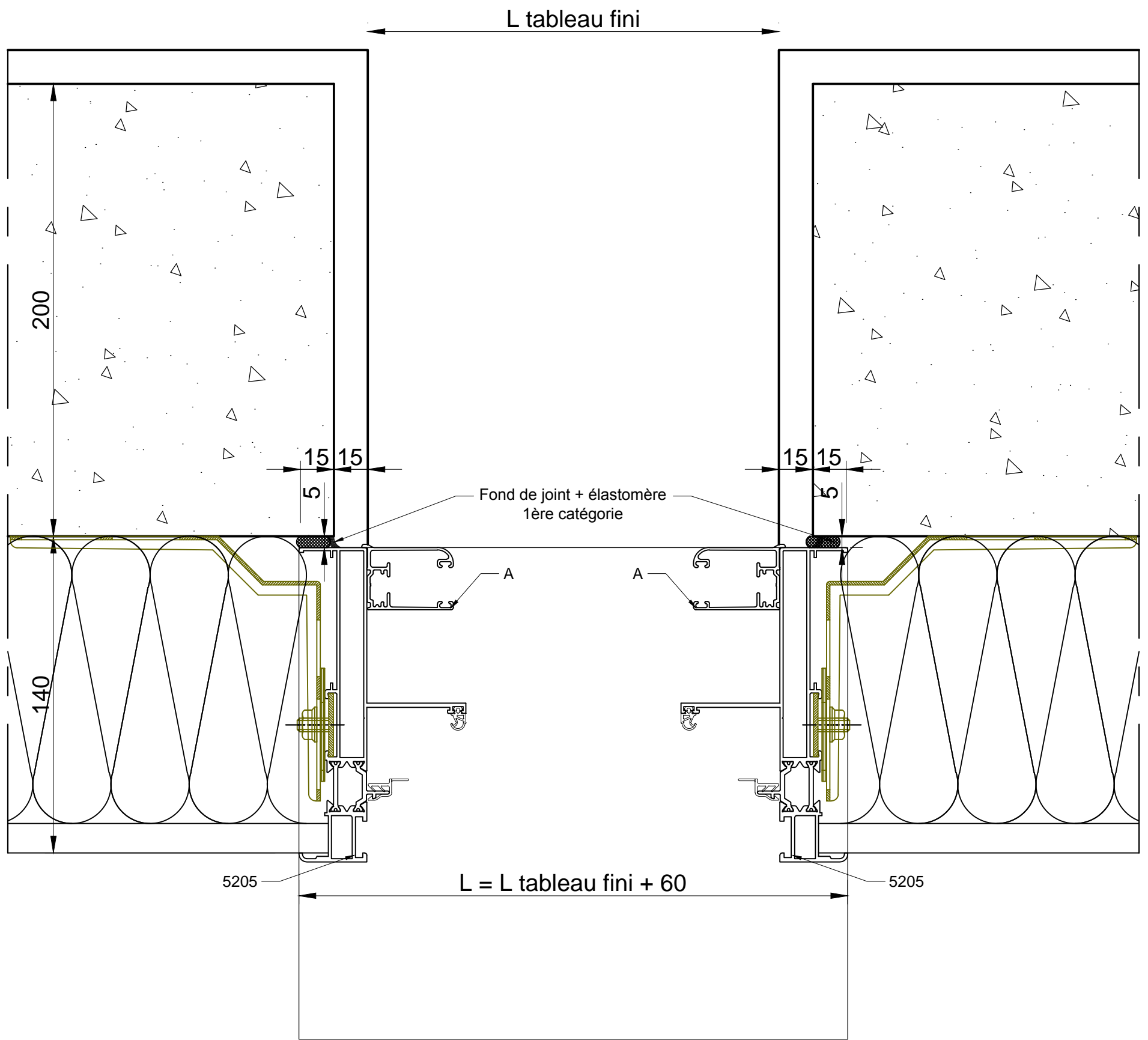

CATA TECH	Dessiné par E. TAVARES	Approuvé par N. BUERMANN	Coupe Horizontale	Modifié le 11/02/2020	Date 28/11/2018	Echelle 1/2 - A3
 Fabricant de Fenêtres et Portes.			APPLIQUE RATRAPAGE ISO 140			
			MISE EN OEUVRE			Edition C

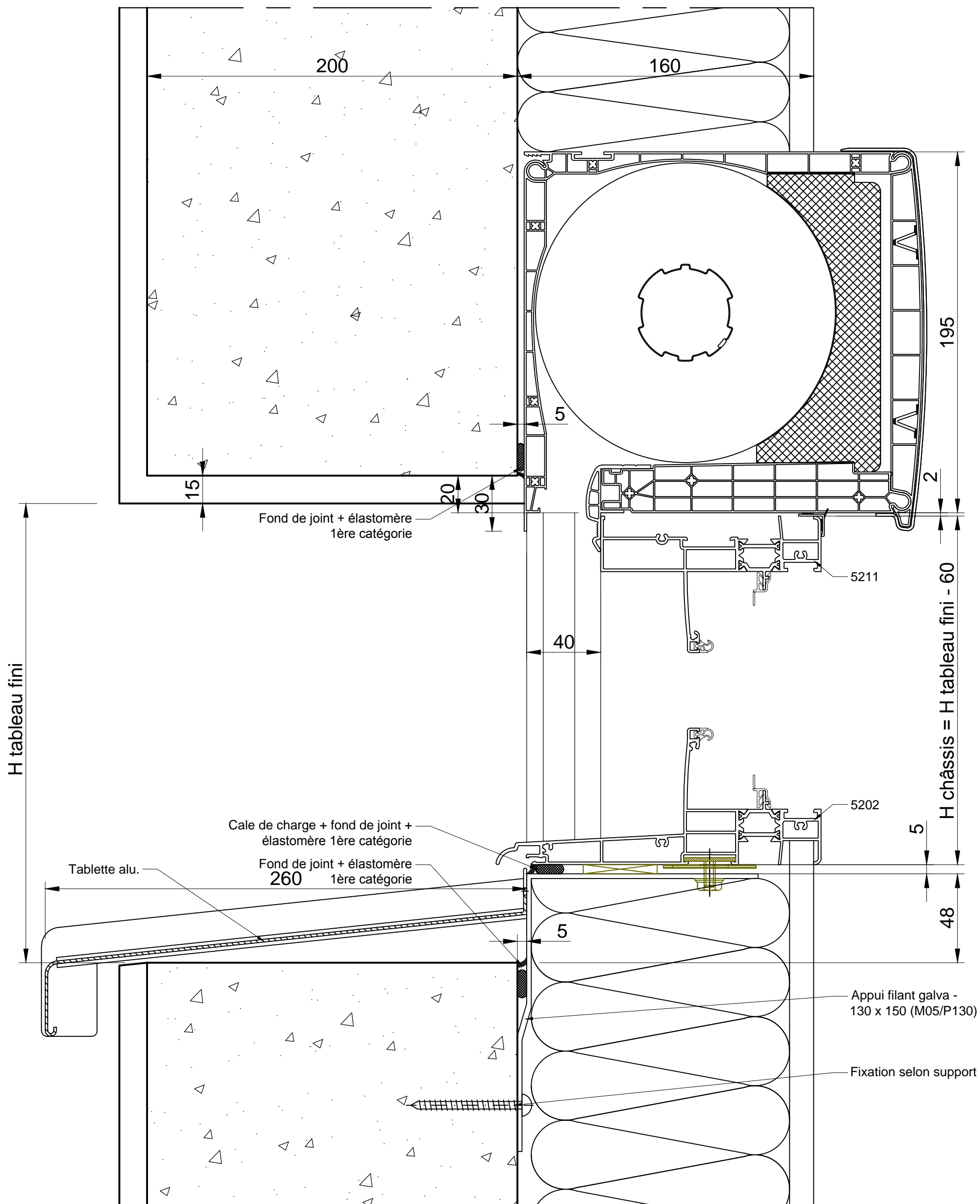

CATA TECH	Dessiné par E. TAVARES	Approuvé par N. BUERMANN	Coupe Verticale	Modifié le 11/02/2020	Date 28/11/2018	Echelle 1/2 - A3
 <p>hilzinger Fabricant de Fenêtres et Portes.</p>			APPLIQUE RATTRAPAGE ISO 160			
			MISE EN OEUVRE			Edition C

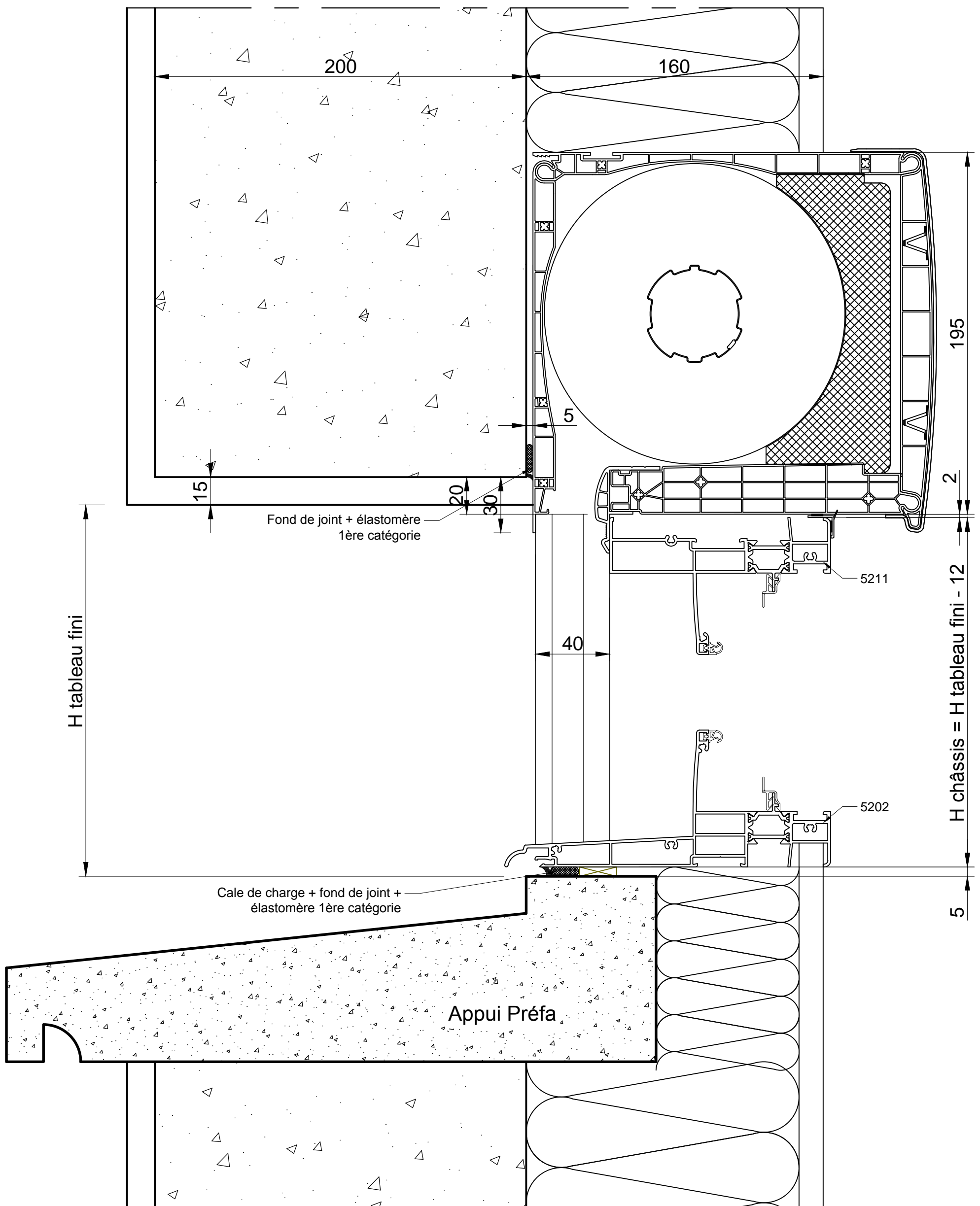

CATA TECH	Dessiné par E. TAVARES	Approuvé par N. BUERMANN	Coupe Verticale	Modifié le 11/02/2020	Date 28/11/2018	Echelle 1/2 - A3
 Fabricant de Fenêtres et Portes.			APPLIQUE RATRAPAGE ISO 160			
			MISE EN OEUVRE			Edition C

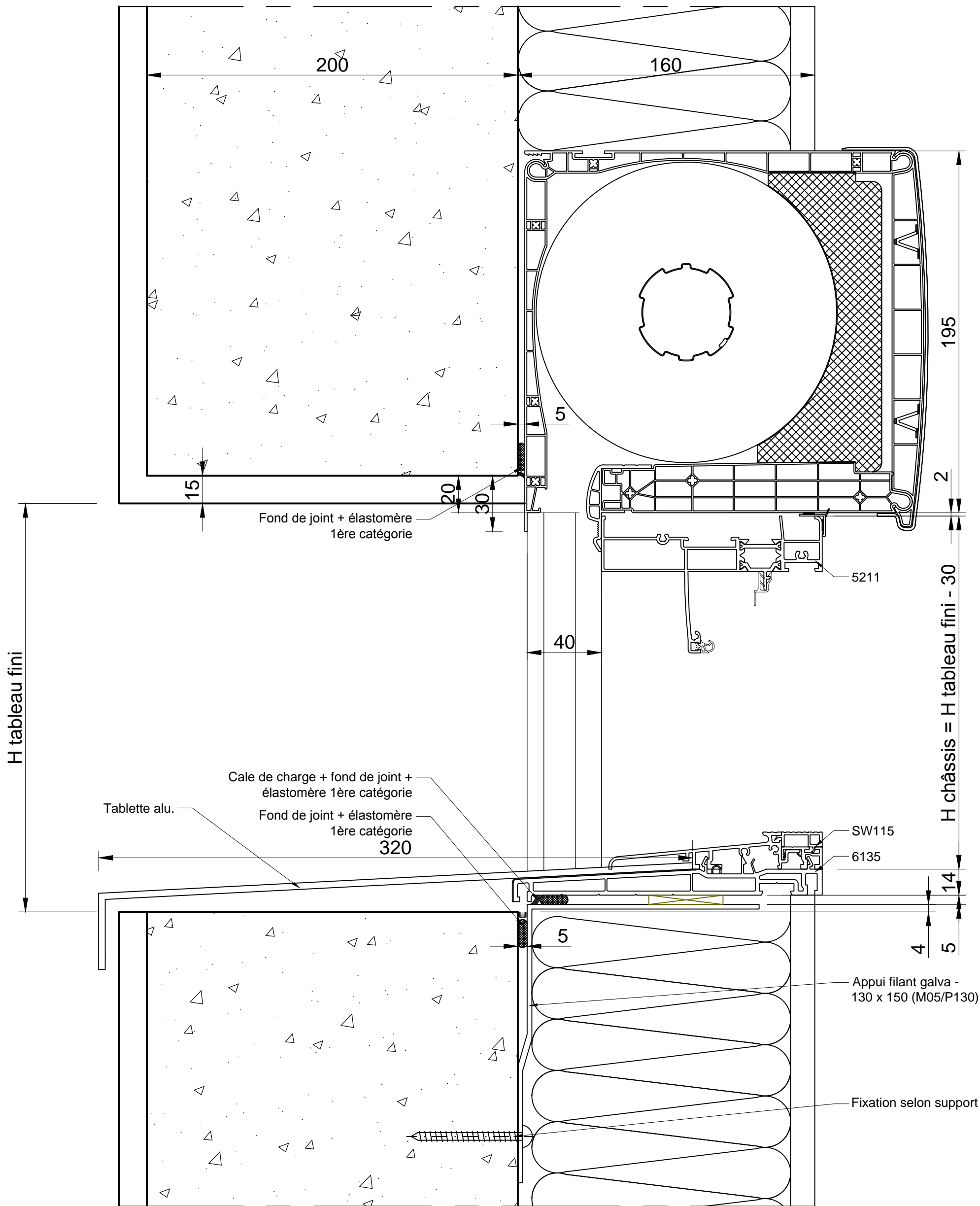

CATA TECH	Dessiné par E. TAVARES	Approuvé par N. BUERMANN	Coupe Verticale	Modifié le 11/02/2020	Date 28/11/2018	Echelle 1/2 - A3
 Fabricant de Fenêtres et Portes.			APPLIQUE RATRAPAGE ISO 160			
			MISE EN OEUVRE			Edition C

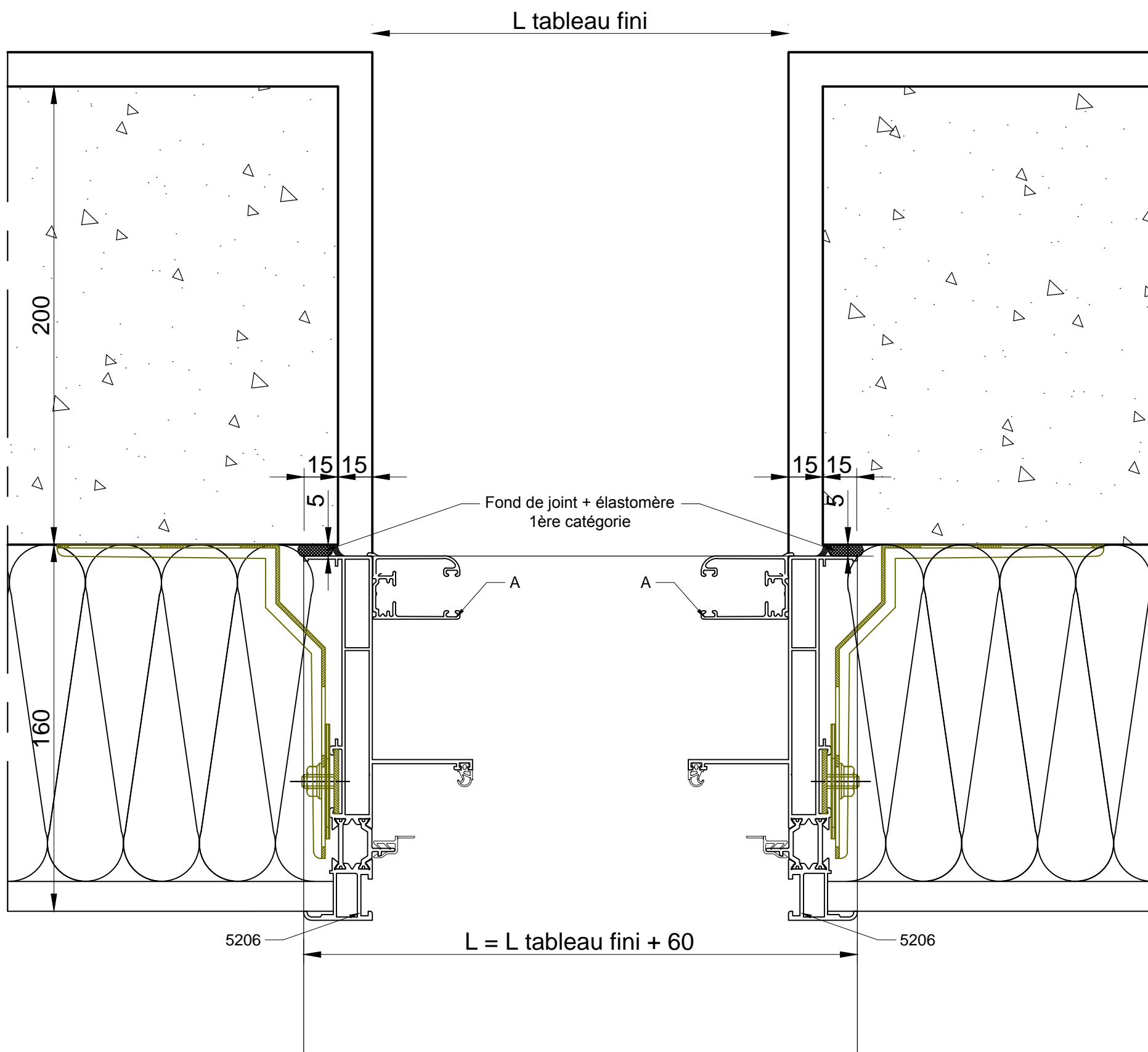

CATA TECH	Dessiné par E. TAVARES	Approuvé par N. BUERMANN	Coupe Horizontale	Modifié le 11/02/2020	Date 28/11/2018	Echelle 1/2 - A3
 Fabricant de Fenêtres et Portes.			APPLIQUE RATRAPAGE ISO 160			
			MISE EN OEUVRE			Edition C

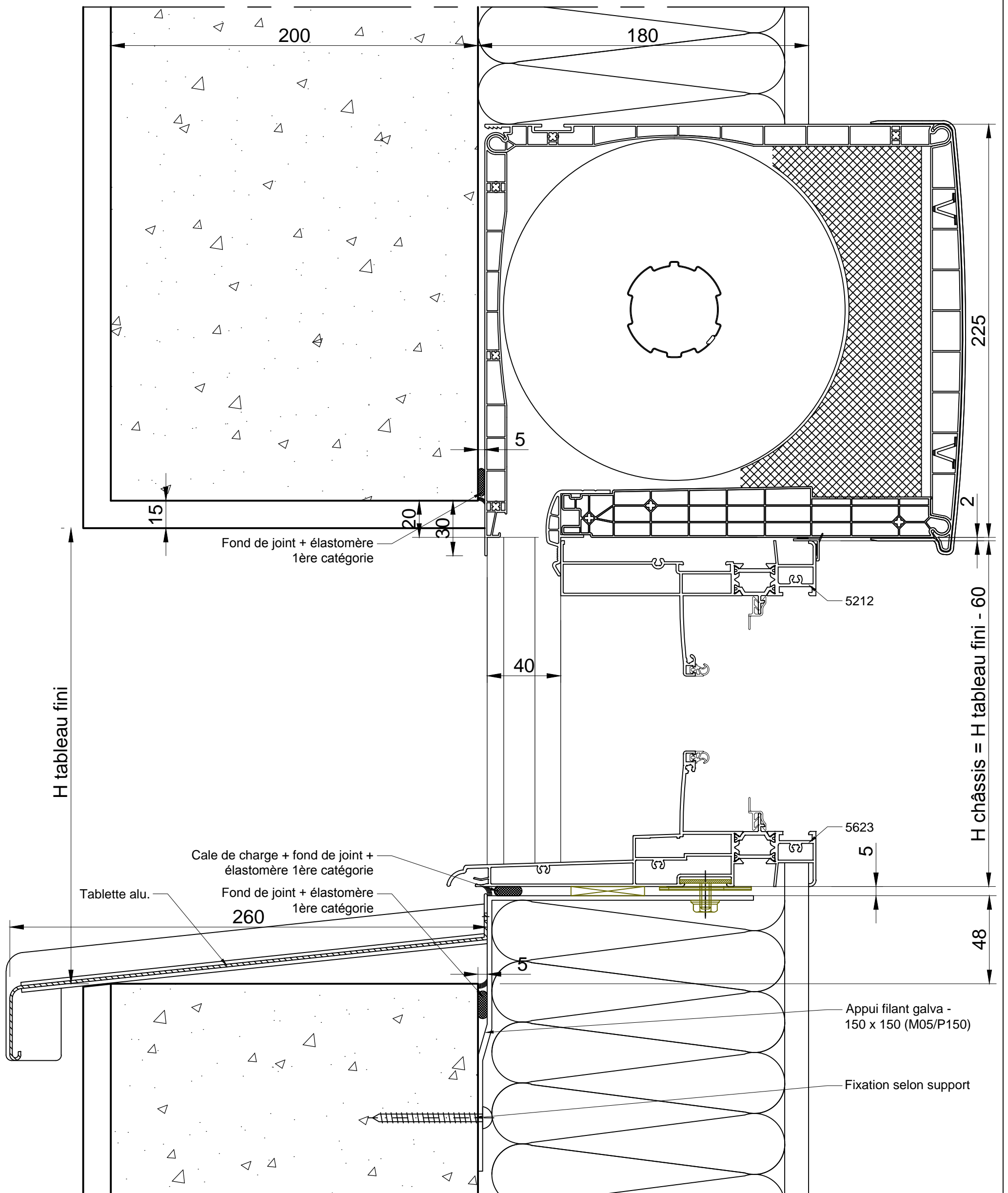

CATA TECH	Dessiné par E. TAVARES	Approuvé par N. BUERMANN	Coupe Verticale	Modifié le 11/02/2020	Date 28/11/2018	Echelle 1/2 - A3
 Fabricant de Fenêtres et Portes.			APPLIQUE RATTRAPAGE ISO 180			
			MISE EN OEUVRE			Edition C

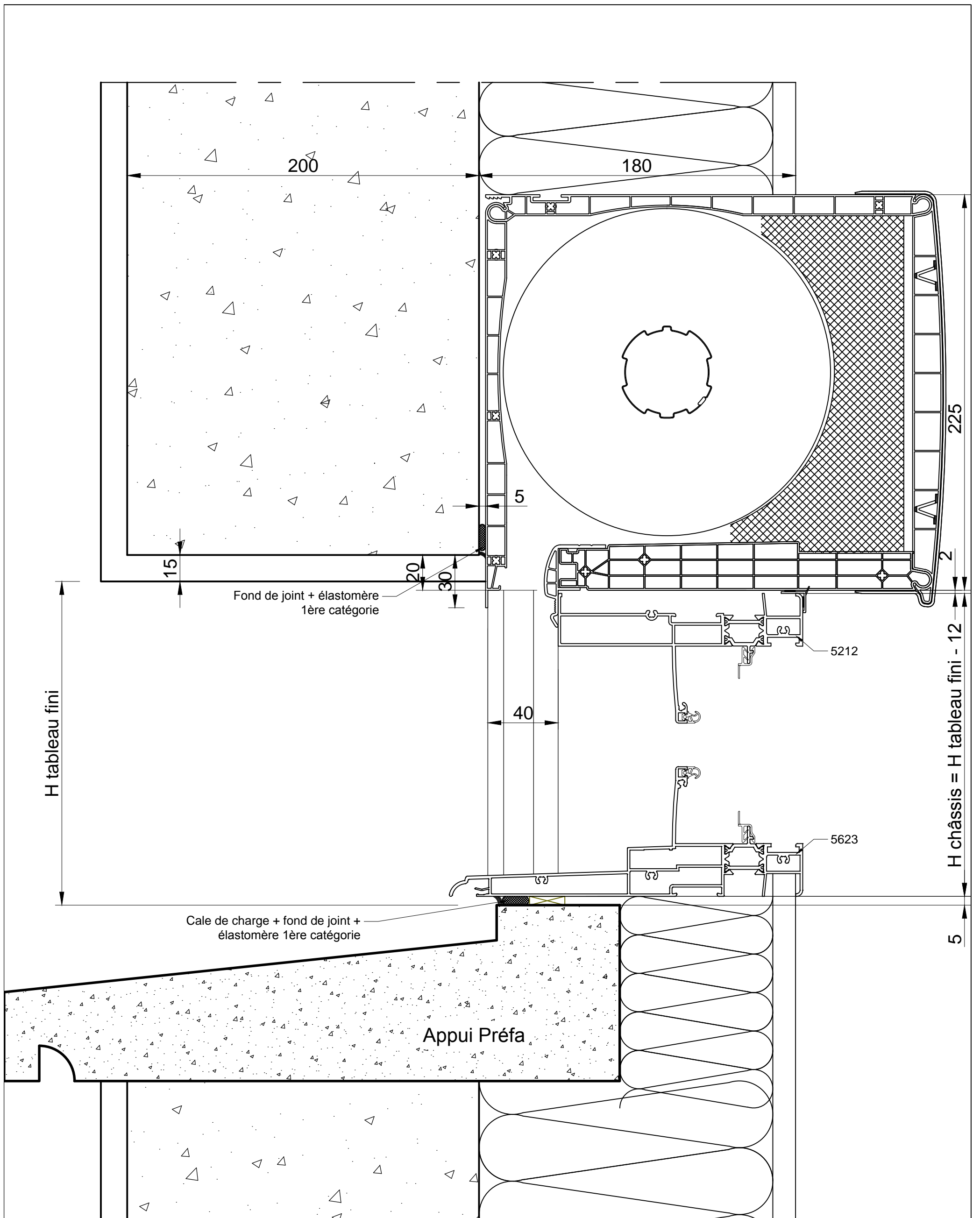

CATA TECH	Dessiné par E. TAVARES	Approuvé par N. BUERMANN	Coupe Verticale	Modifié le 11/02/2020	Date 28/11/2018	Echelle 1/2 - A3
 <p>hilzinger Fabricant de Fenêtres et Portes.</p>			APPLIQUE RATTRAPAGE ISO 180			
			MISE EN OEUVRE			Edition C

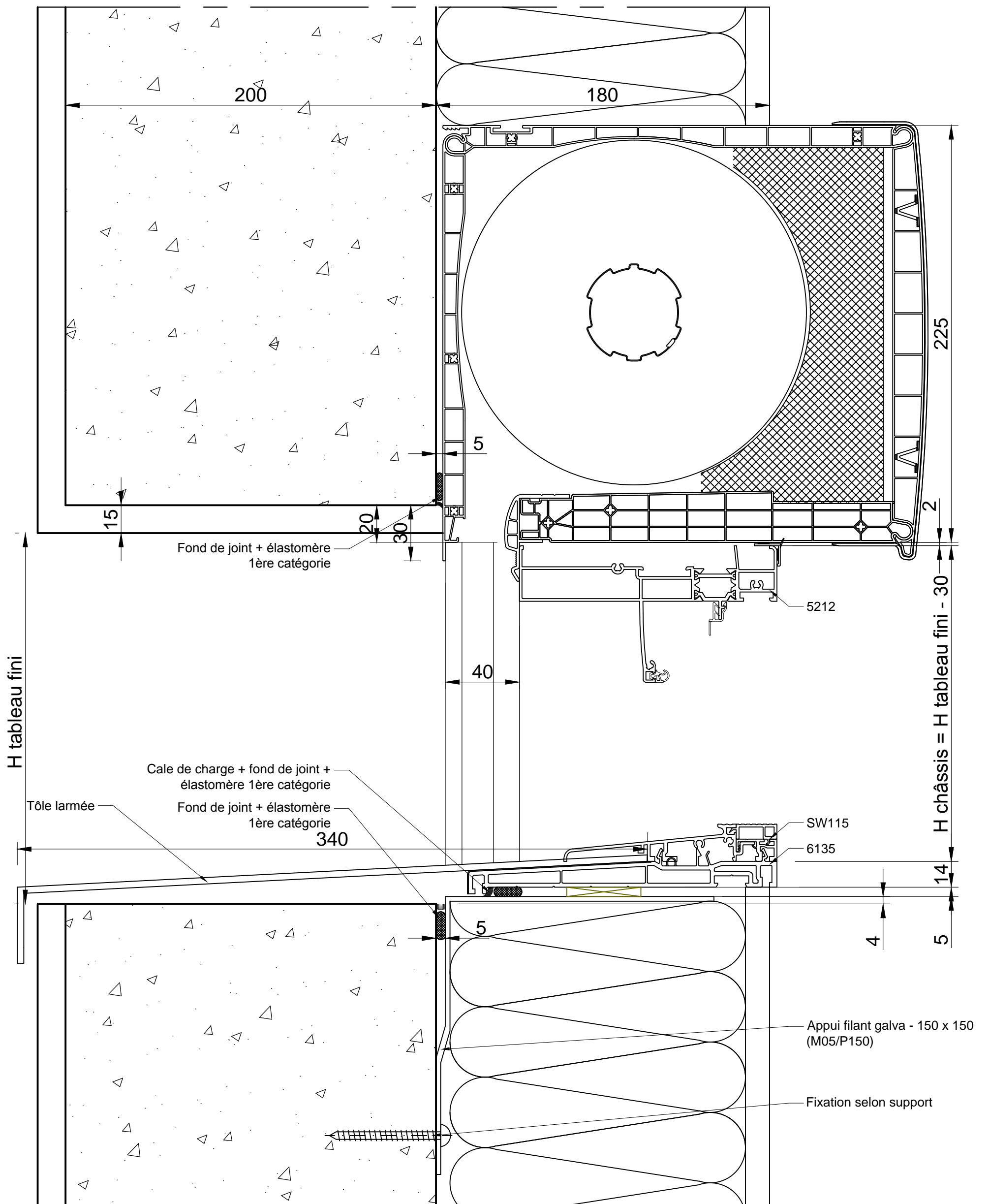

CATA TECH	Dessiné par E. TAVARES	Approuvé par N. BUERMANN	Coupe Verticale	Modifié le 11/02/2020	Date 28/11/2018	Echelle 1/2 - A3
 Fabricant de Fenêtres et Portes.			APPLIQUE RATTRAPAGE ISO 180			
			MISE EN OEUVRE		Edition C	Feuille No. ALU 19

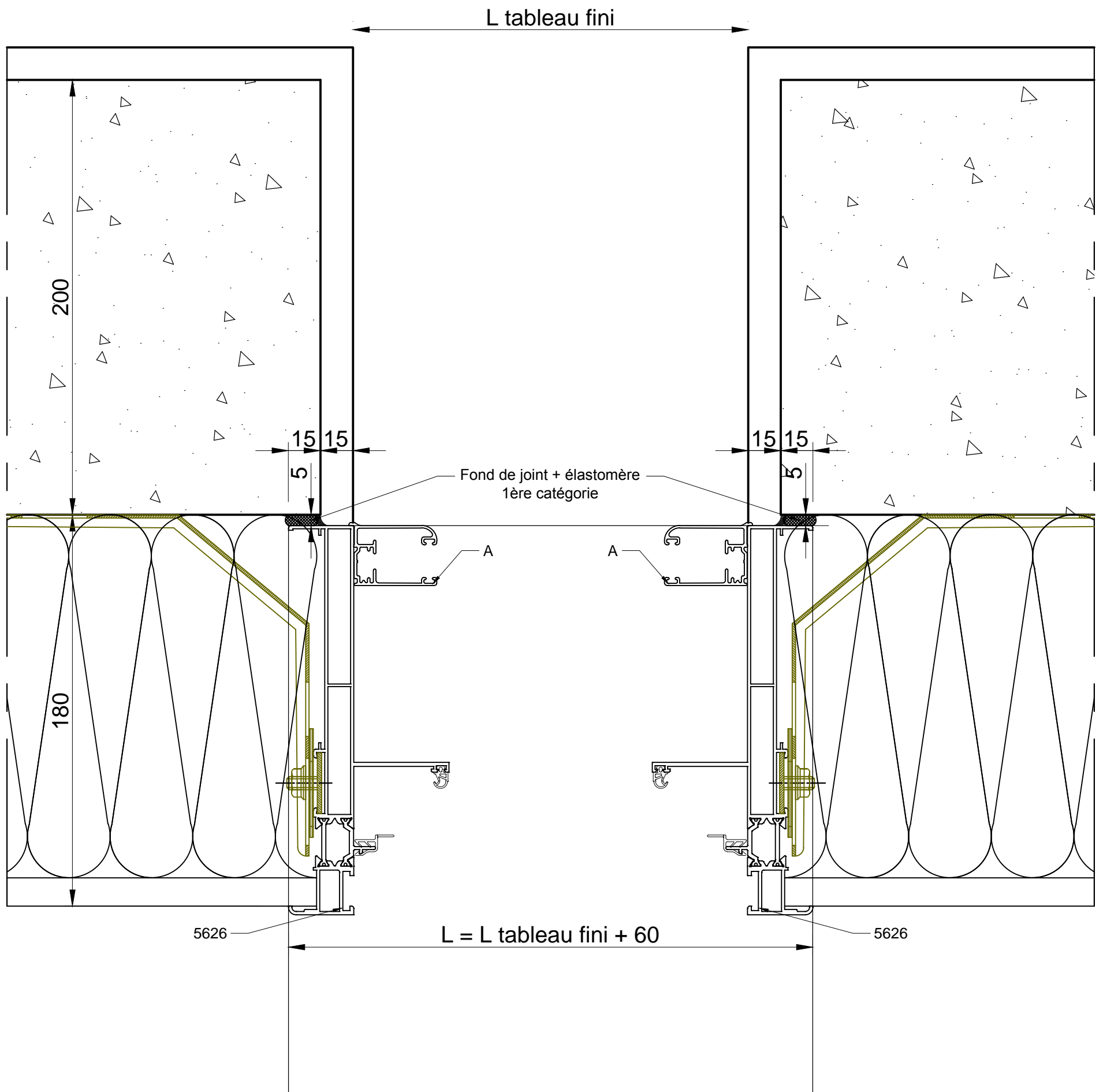

CATA TECH	Dessiné par E. TAVARES	Approuvé par N. BUERMANN	Coupe Horizontale	Modifié le 11/02/2020	Date 28/11/2018	Echelle 1/2 - A3
 Fabricant de Fenêtres et Portes.			APPLIQUE RATTRAPAGE ISO 180			
			MISE EN OEUVRE			Edition C

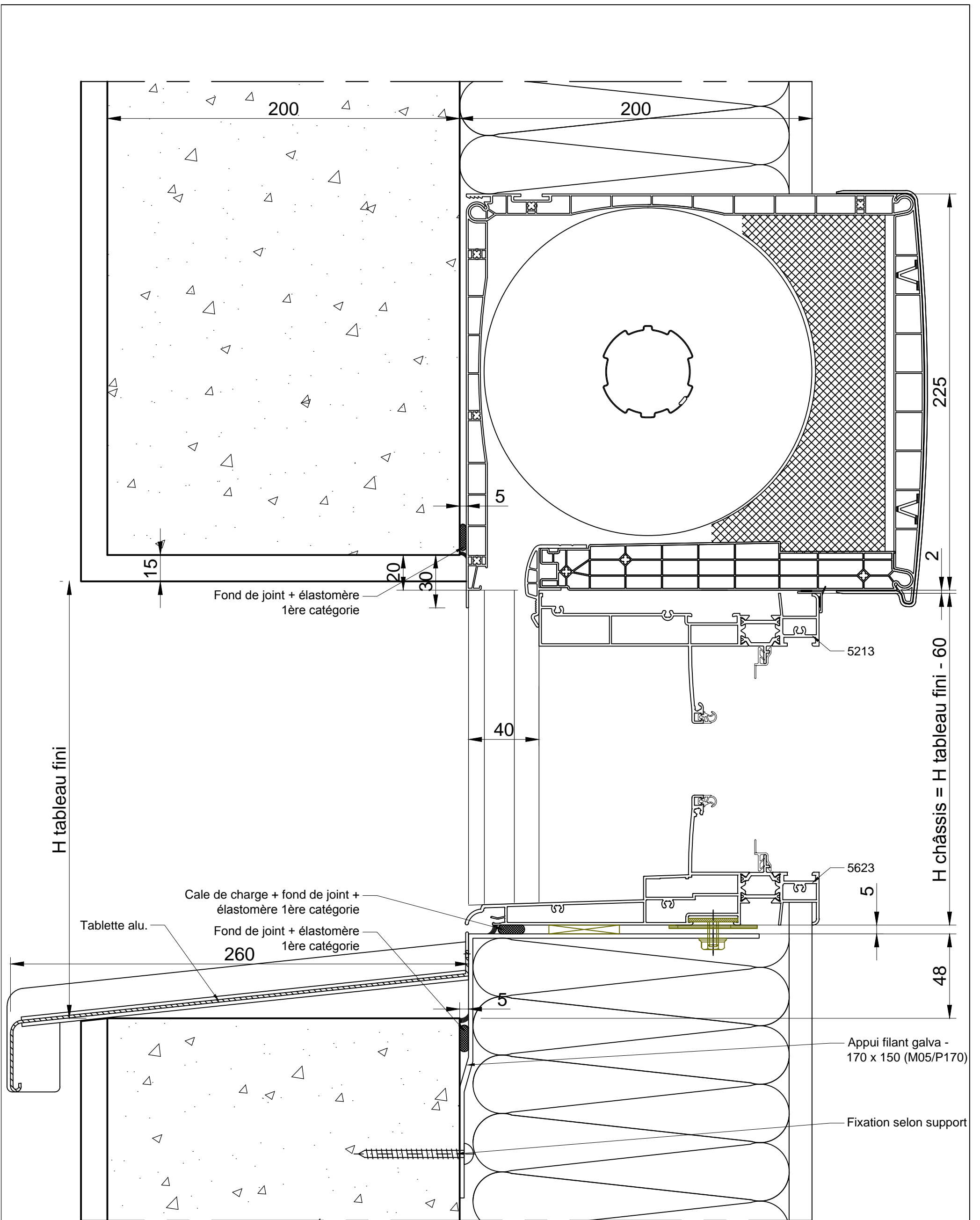

CATA TECH	Dessiné par E. TAVARES	Approuvé par N. BUERMANN	Coupe Verticale	Modifié le 11/02/2020	Date 28/11/2018	Echelle 1/2 - A3
 Fabricant de Fenêtres et Portes.			APPLIQUE RATTRAPAGE ISO 200			
			MISE EN OEUVRE		Edition C	Feuille No. ALU 21

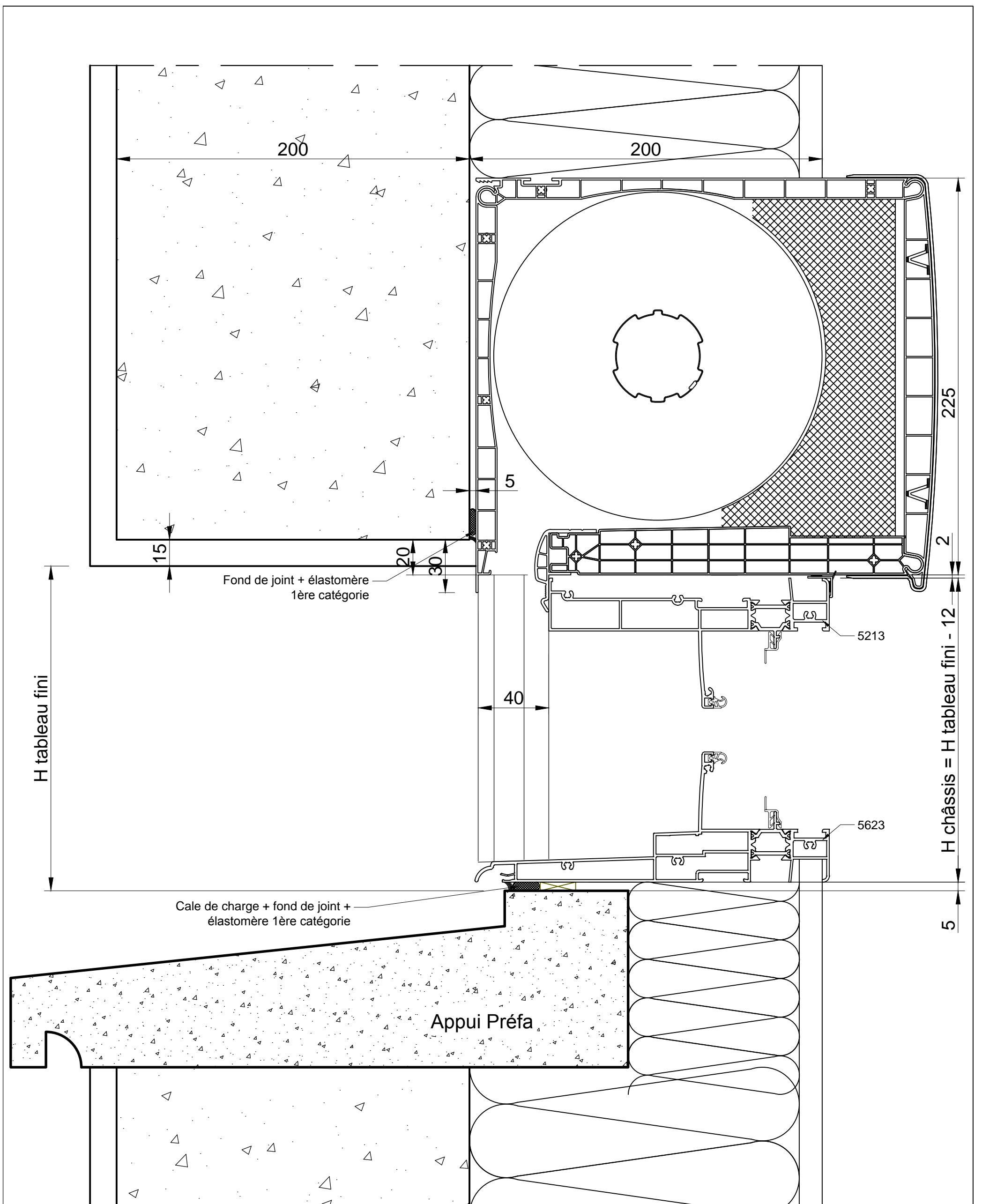

CATA TECH	Dessiné par E. TAVARES	Approuvé par N. BUERMANN	Coupe Verticale	Modifié le 11/02/2020	Date 28/11/2018	Echelle 1/2 - A3
 Fabricant de Fenêtres et Portes.			APPLIQUE RATRAPAGE ISO 200			
			MISE EN OEUVRE			Edition C

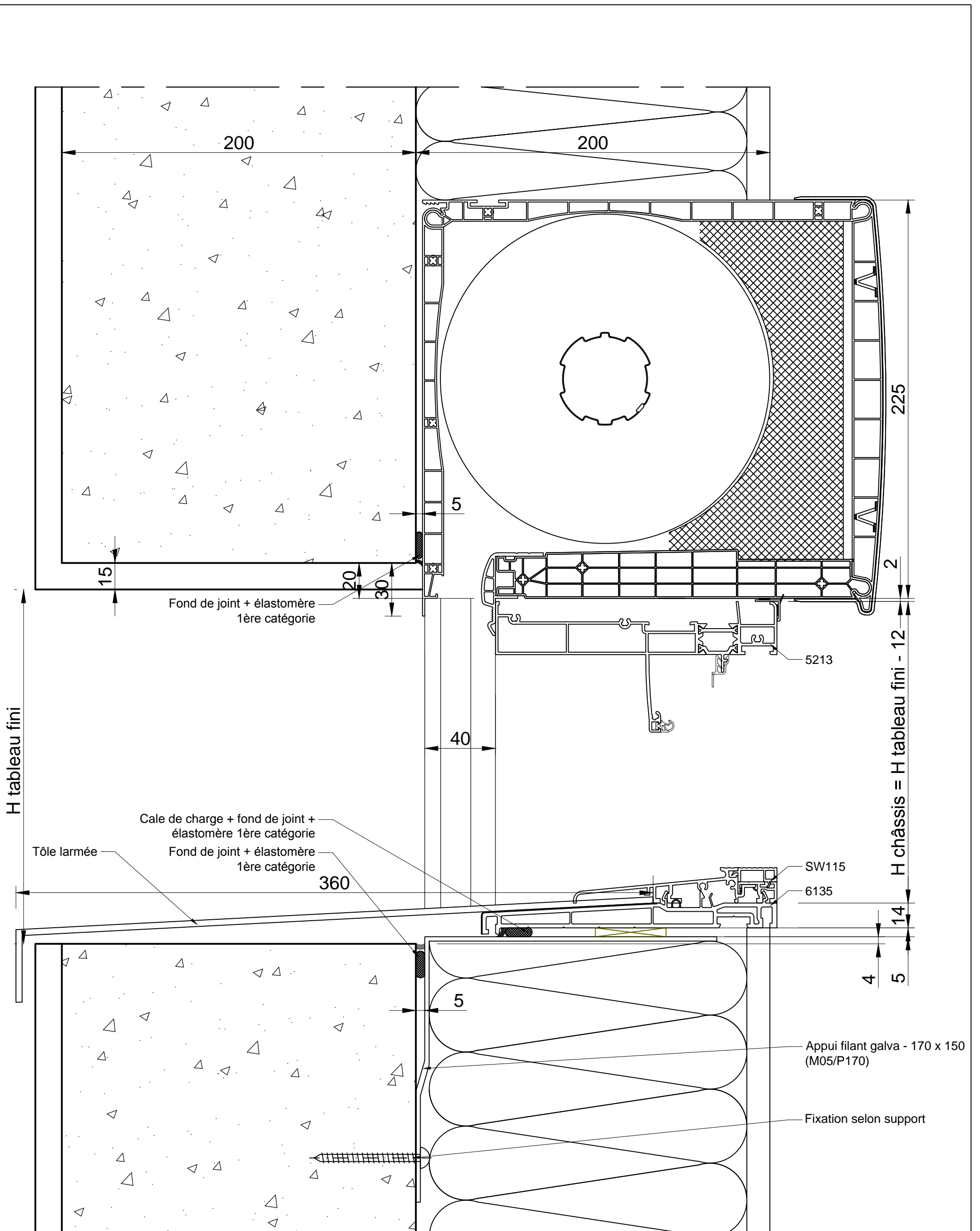

CATA TECH	Dessiné par E. TAVARES	Approuvé par N. BUERMANN	Coupe Verticale	Modifié le 11/02/2020	Date 28/11/2018	Echelle 1/2 - A3
 Fabricant de Fenêtres et Portes.			APPLIQUE RATTRAPAGE ISO 200			
			MISE EN OEUVRE			Edition C

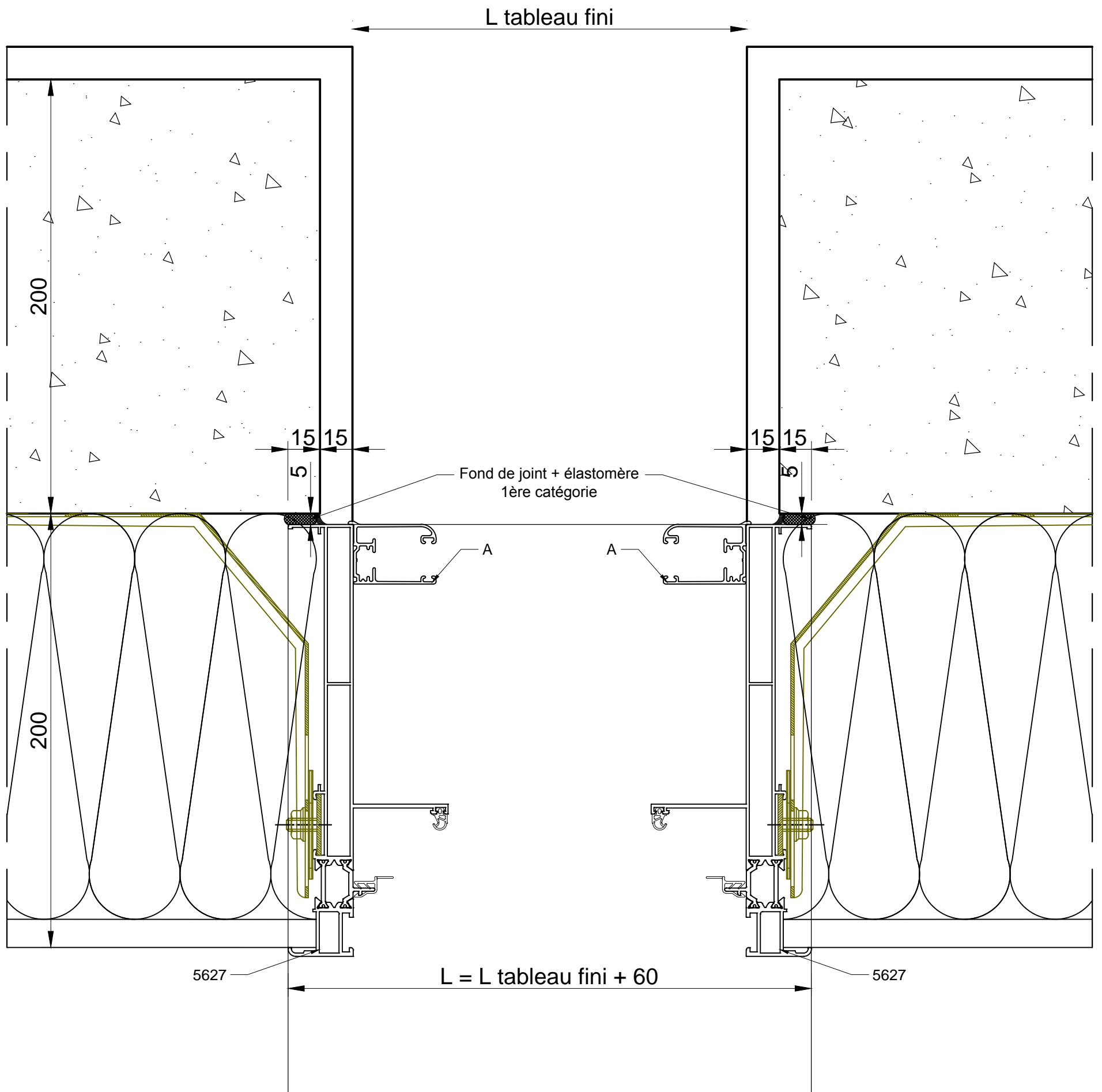

CATA TECH	Dessiné par E. TAVARES	Approuvé par N. BUERMANN	Coupe Horizontale	Modifié le 11/02/2020	Date 28/11/2018	Echelle 1/2 - A3
 Fabricant de Fenêtres et Portes.			APPLIQUE RATTRAPAGE ISO 200			
			MISE EN OEUVRE			Edition C

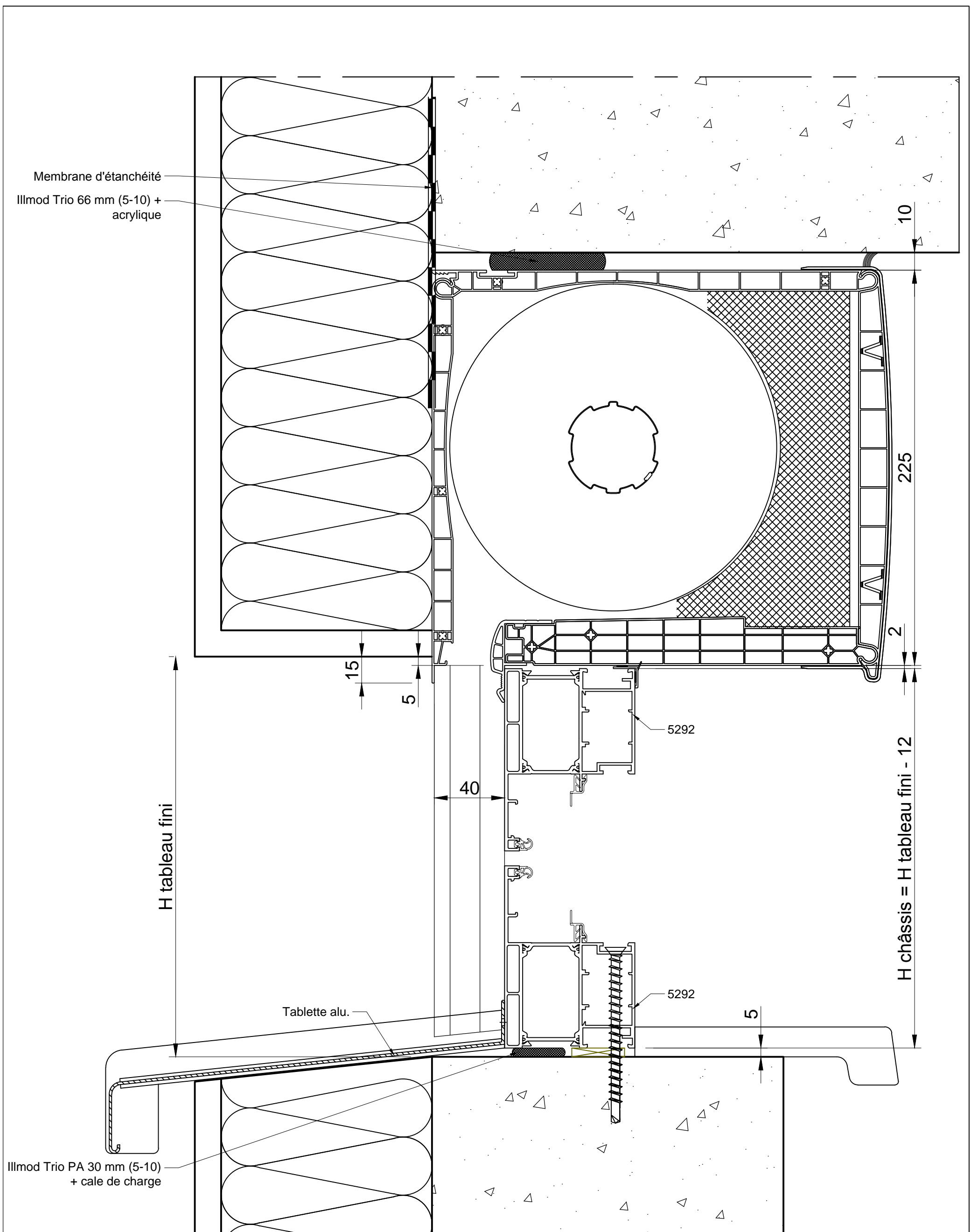

CATA TECH	Dessiné par E. TAVARES	Approuvé par N. BUERMANN	Coupe Verticale	Modifié le 11/02/2020	Date 28/11/2018	Echelle 1/2 - A3
 Fabricant de Fenêtres et Portes.			POSE EN TUNNEL			
			MISE EN OEUVRE	Edition C	Feuille No. ALU 25	

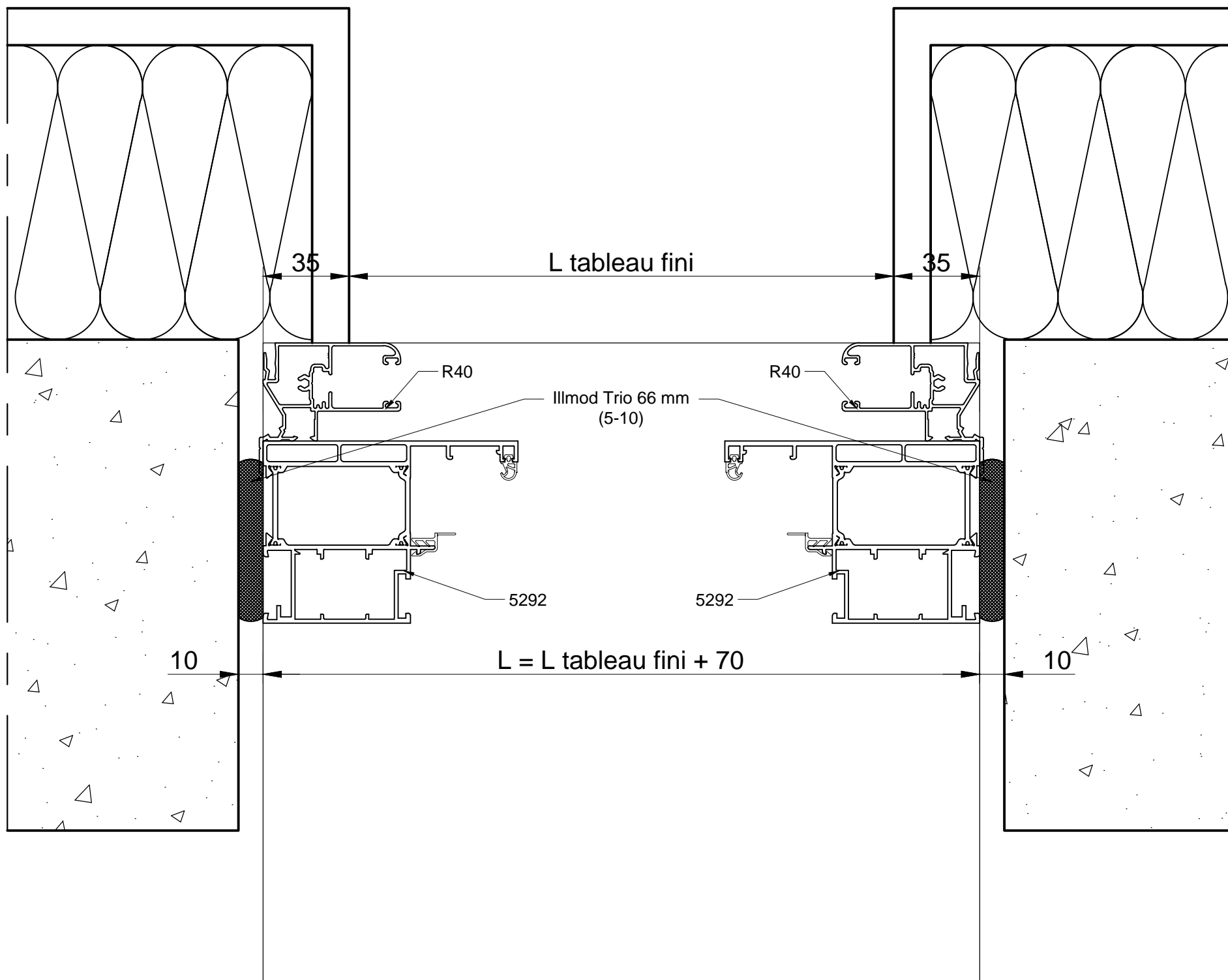

CATA TECH	Dessiné par E. TAVARES	Approuvé par N. BUERMANN	Coupe Horizontale	Modifié le 11/02/2020	Date 28/11/2018	Echelle 1/2 - A3
 Fabricant de Fenêtres et Portes.			POSE EN TUNNEL			
			MISE EN OEUVRE	Edition C	Feuille No. ALU 26	

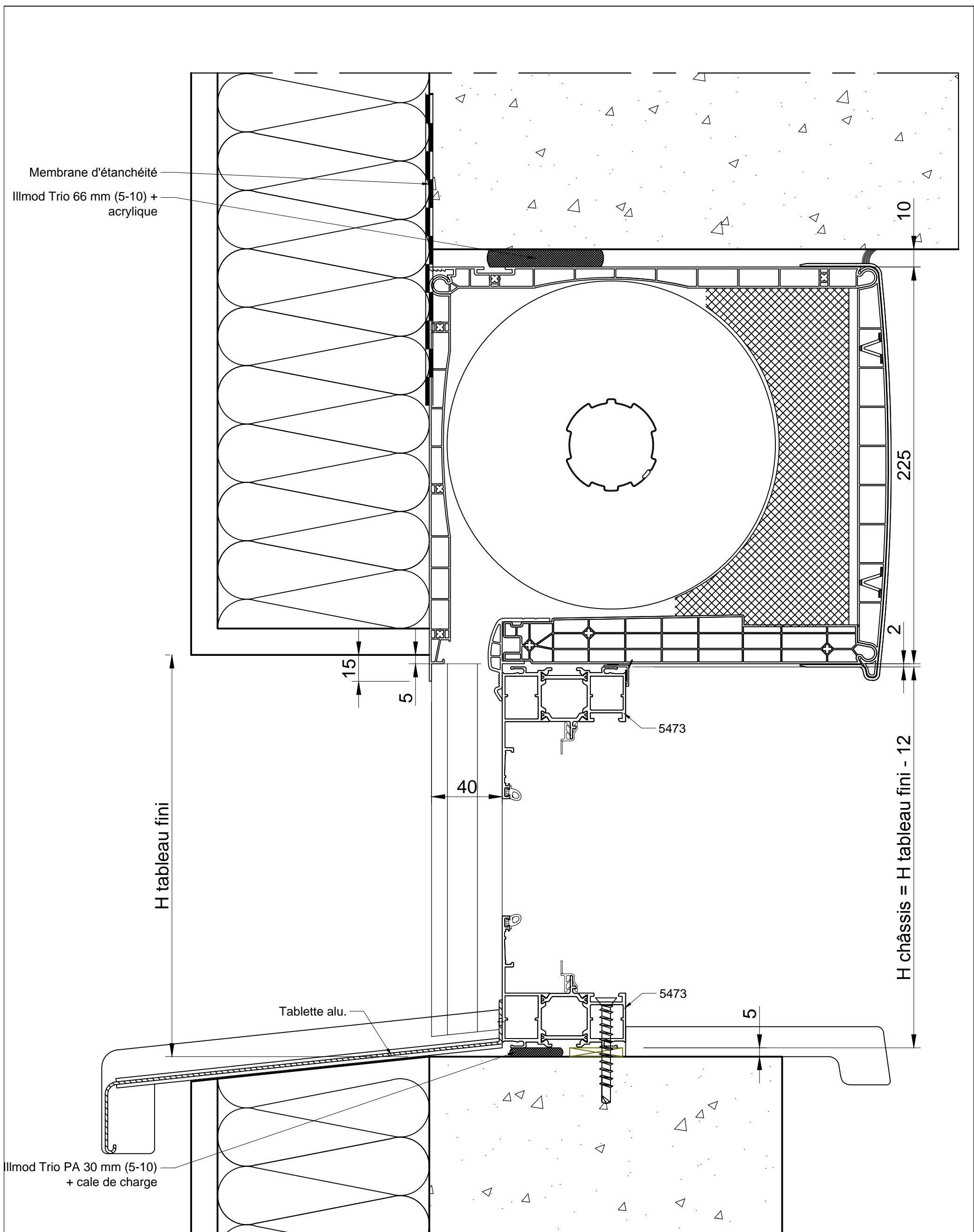

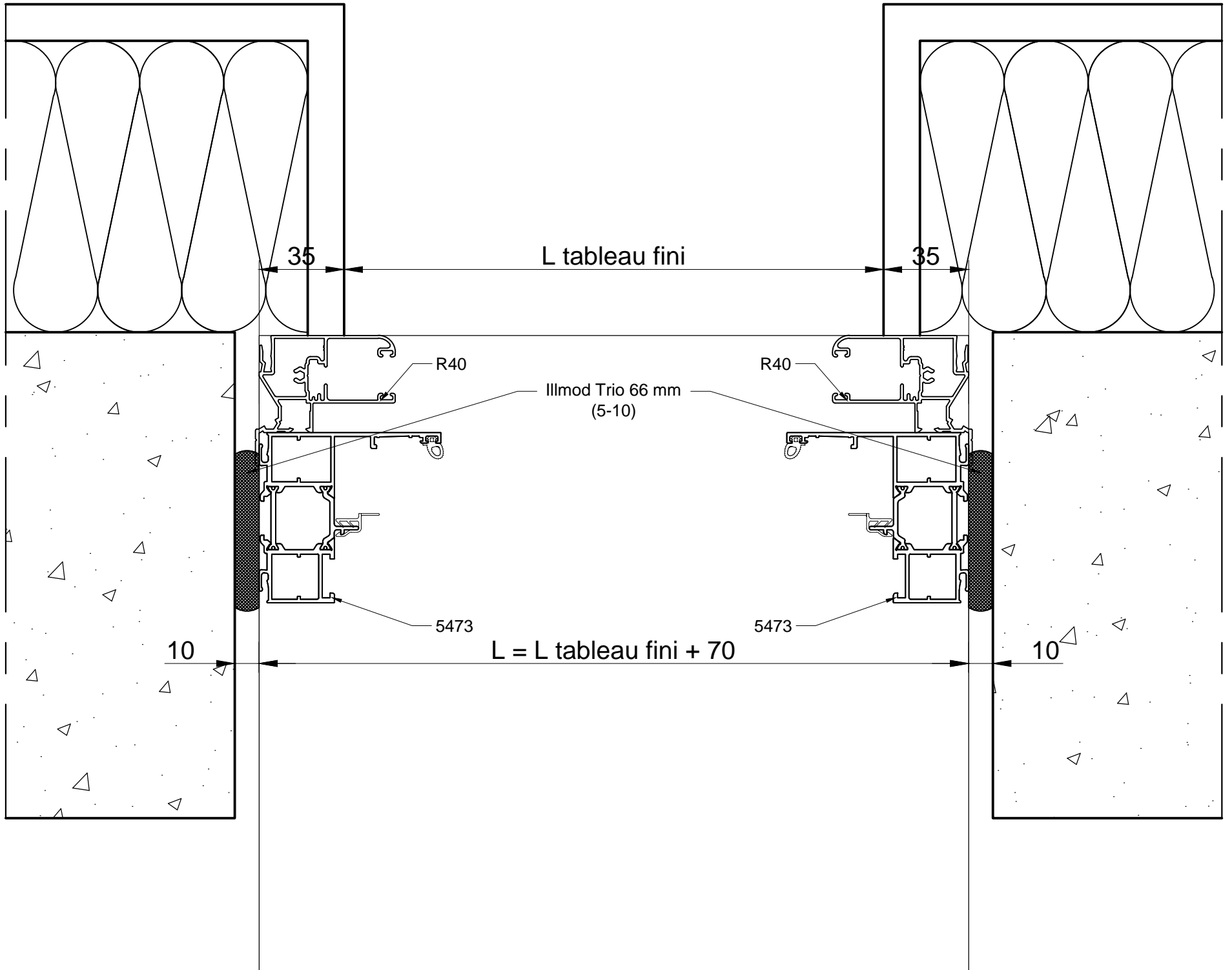

CATA TECH	Dessiné par E. TAVARES	Approuvé par N. BUERMANN	Coupe Verticale	Modifié le 11/02/2020	Date 28/11/2018	Echelle 1/2 - A3
 Fabricant de Fenêtres et Portes.			POSE EN TUNNEL			
			MISE EN OEUVRE	Edition C	Feuille No. ALU 27	



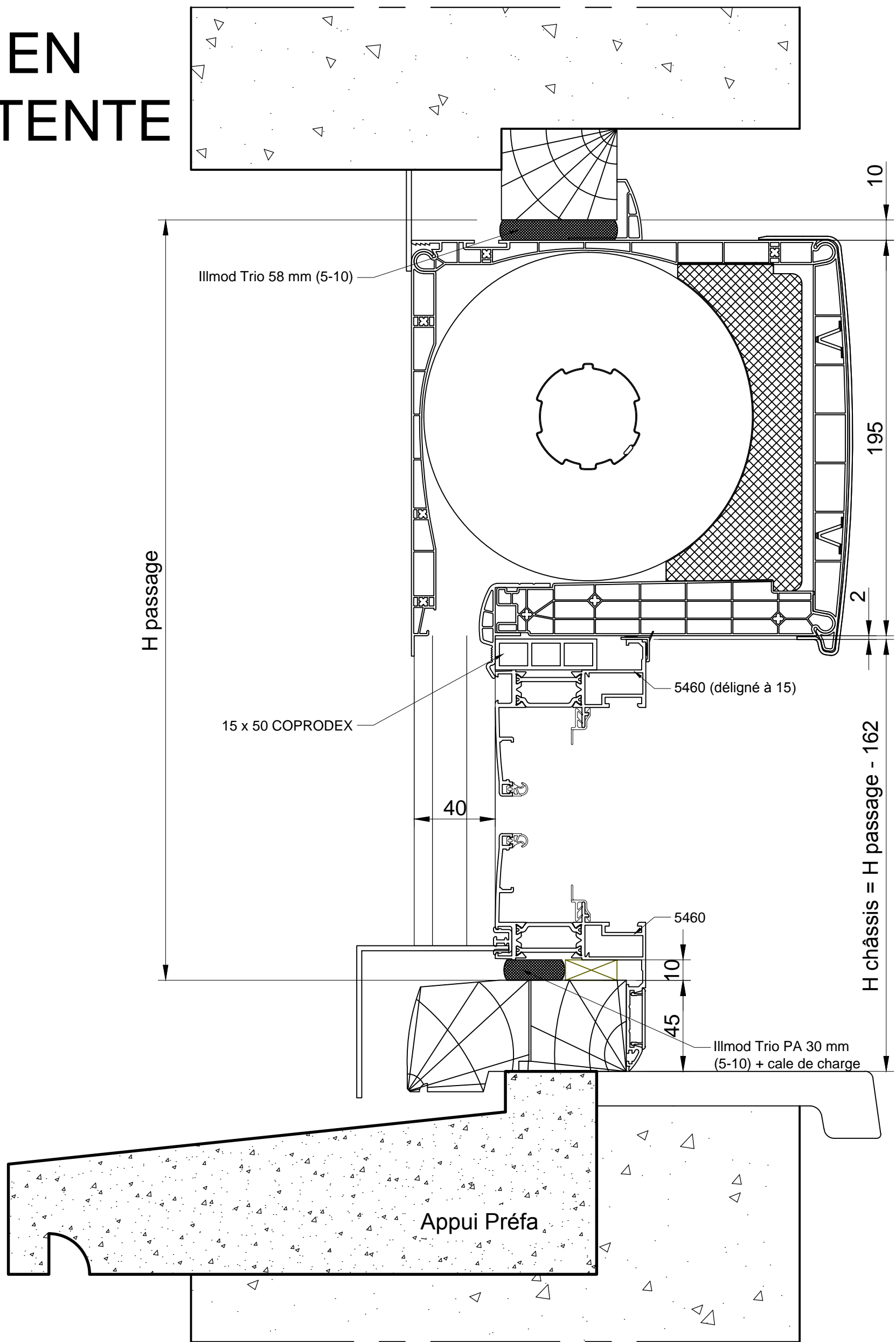

CATA TECH	Dessiné par E. TAVARES	Approuvé par N. BUERMANN	Coupe Horizontale	Modifié le 11/02/2020	Date 28/11/2018	Echelle 1/2 - A3
 Fabricant de Fenêtres et Portes.			POSE EN TUNNEL			
			MISE EN OEUVRE	Edition C	Feuille No. ALU 28	

EN ATTENTE



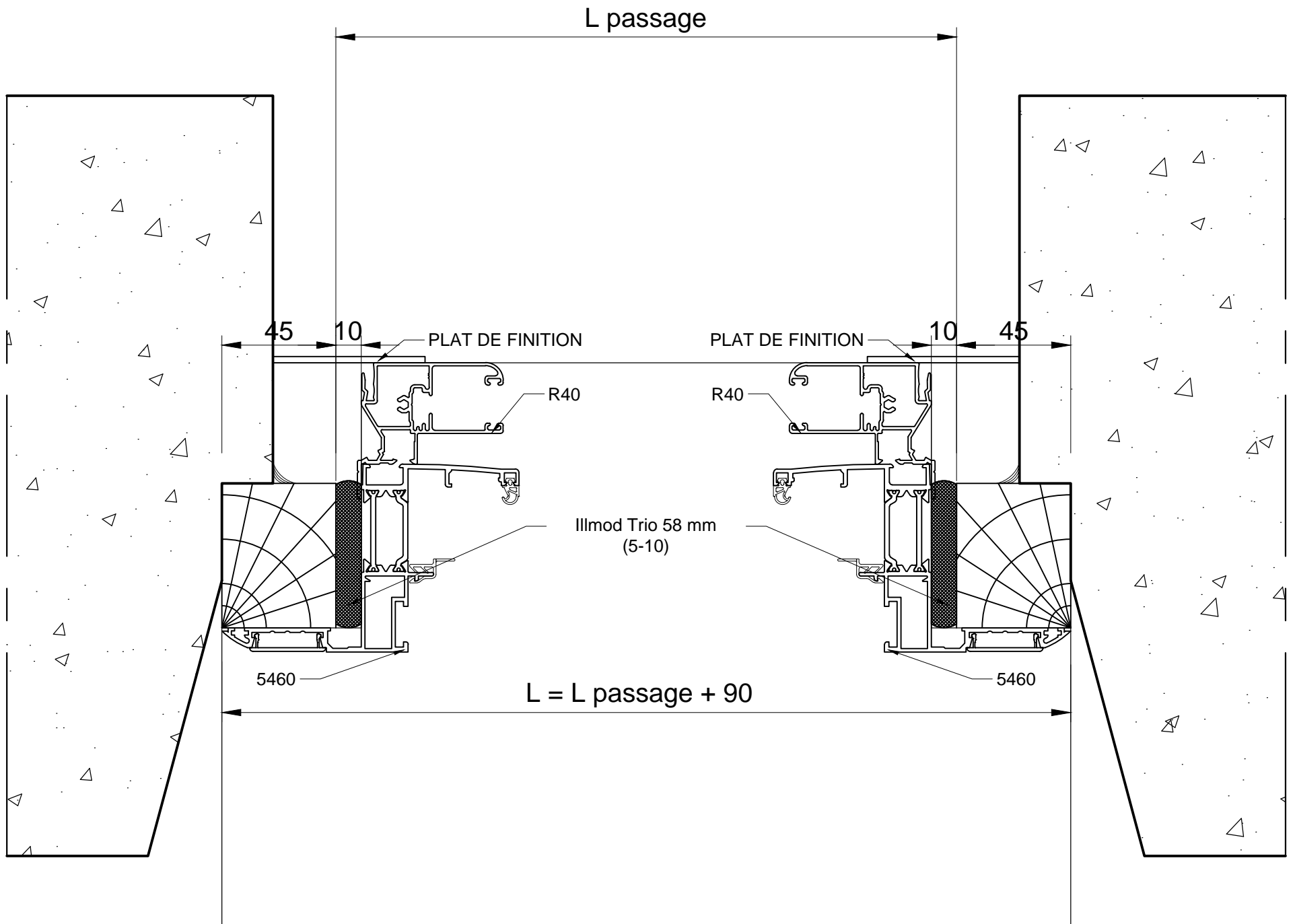

CATA TECH	Dessiné par E. TAVARES	Approuvé par N. BUERMANN	Coupe Verticale	Modifié le 11/02/2020	Date 28/11/2018	Echelle 1/2 - A3
 Fabricant de Fenêtres et Portes.			RENOVATION			
			MISE EN OEUVRE	Edition C	Feuille No. ALU 29	



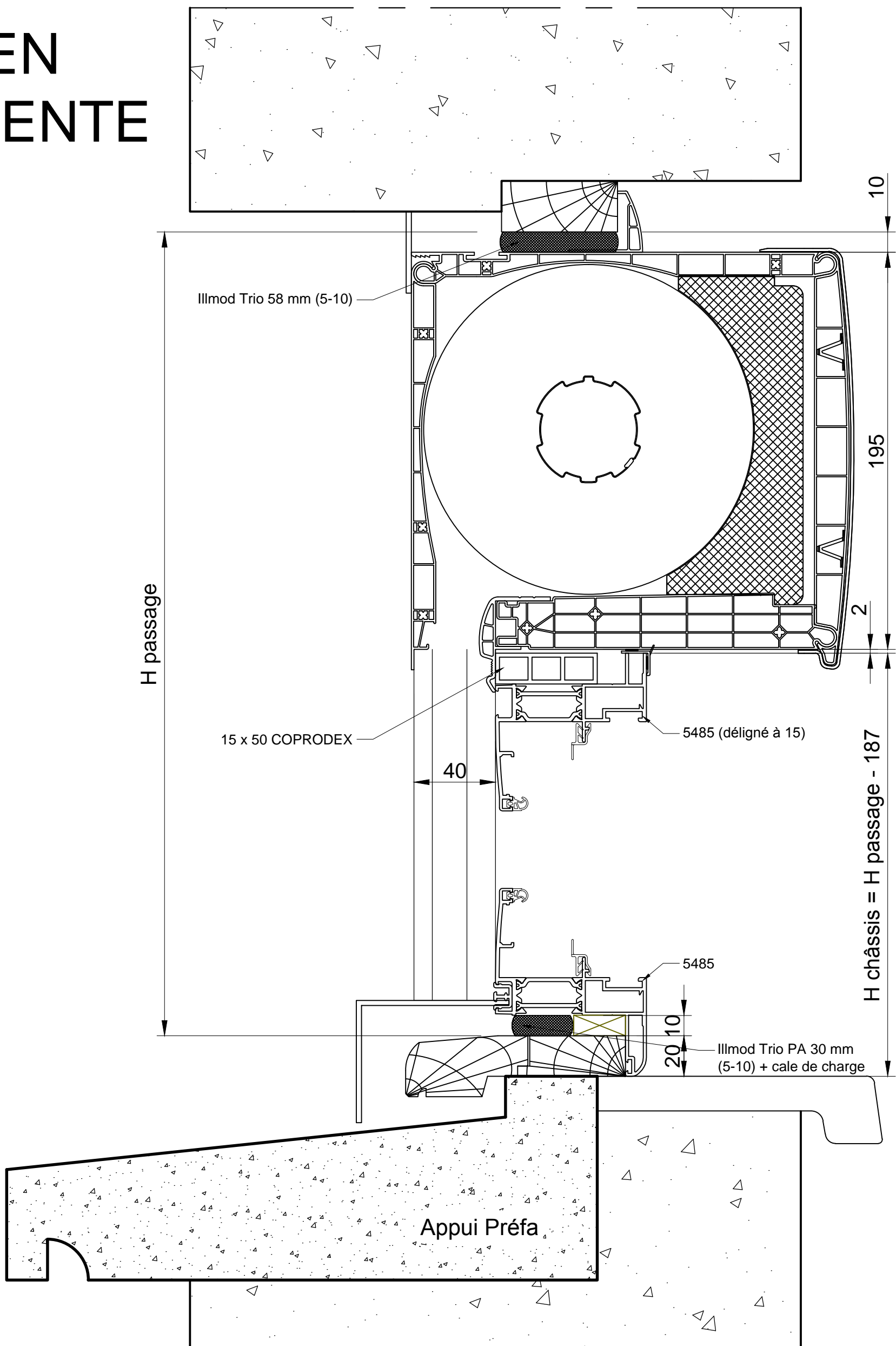

CATA TECH	Dessiné par E. TAVARES	Approuvé par N. BUERMANN	Coupe Horizontale	Modifié le 11/02/2020	Date 28/11/2018	Echelle 1/2 - A3
 Fabricant de Fenêtres et Portes.			RENOVATION			
			MISE EN OEUVRE		Edition C	Feuille No. ALU 30

EN ATTENTE

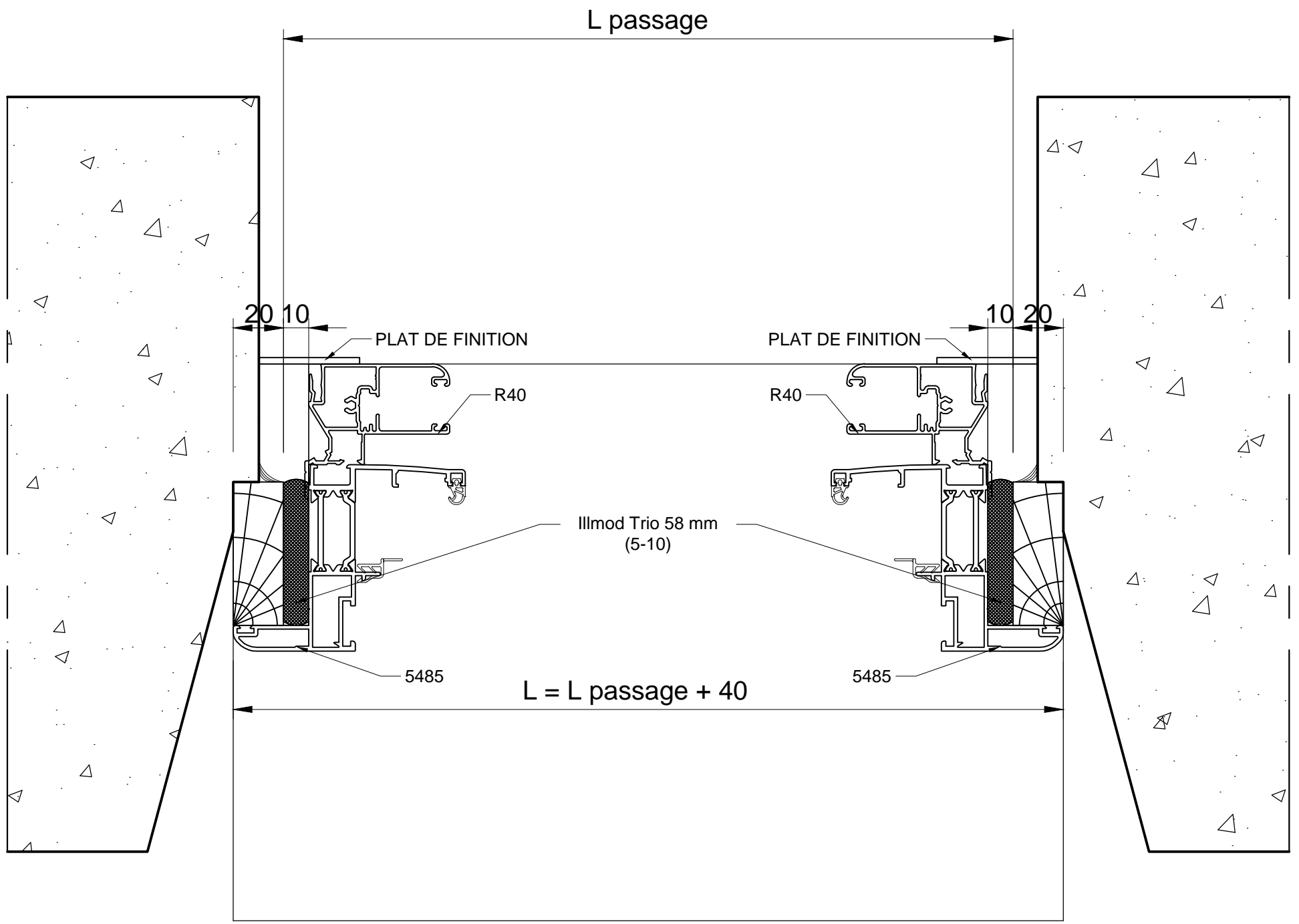

CATA TECH	Dessiné par E. TAVARES	Approuvé par N. BUERMANN	Coupe Verticale	Modifié le 11/02/2020	Date 28/11/2018	Echelle 1/2 - A3
 Fabricant de Fenêtres et Portes.			RENOVATION			
			MISE EN OEUVRE	Edition C	Feuille No. ALU 31	



CATA TECH	Dessiné par E. TAVARES	Approuvé par N. BUERMANN	Coupe Horizontale	Modifié le 11/02/2020	Date 28/11/2018	Echelle 1/2 - A3
 Fabricant de Fenêtres et Portes.			RENOVATION			
			MISE EN OEUVRE			Edition C

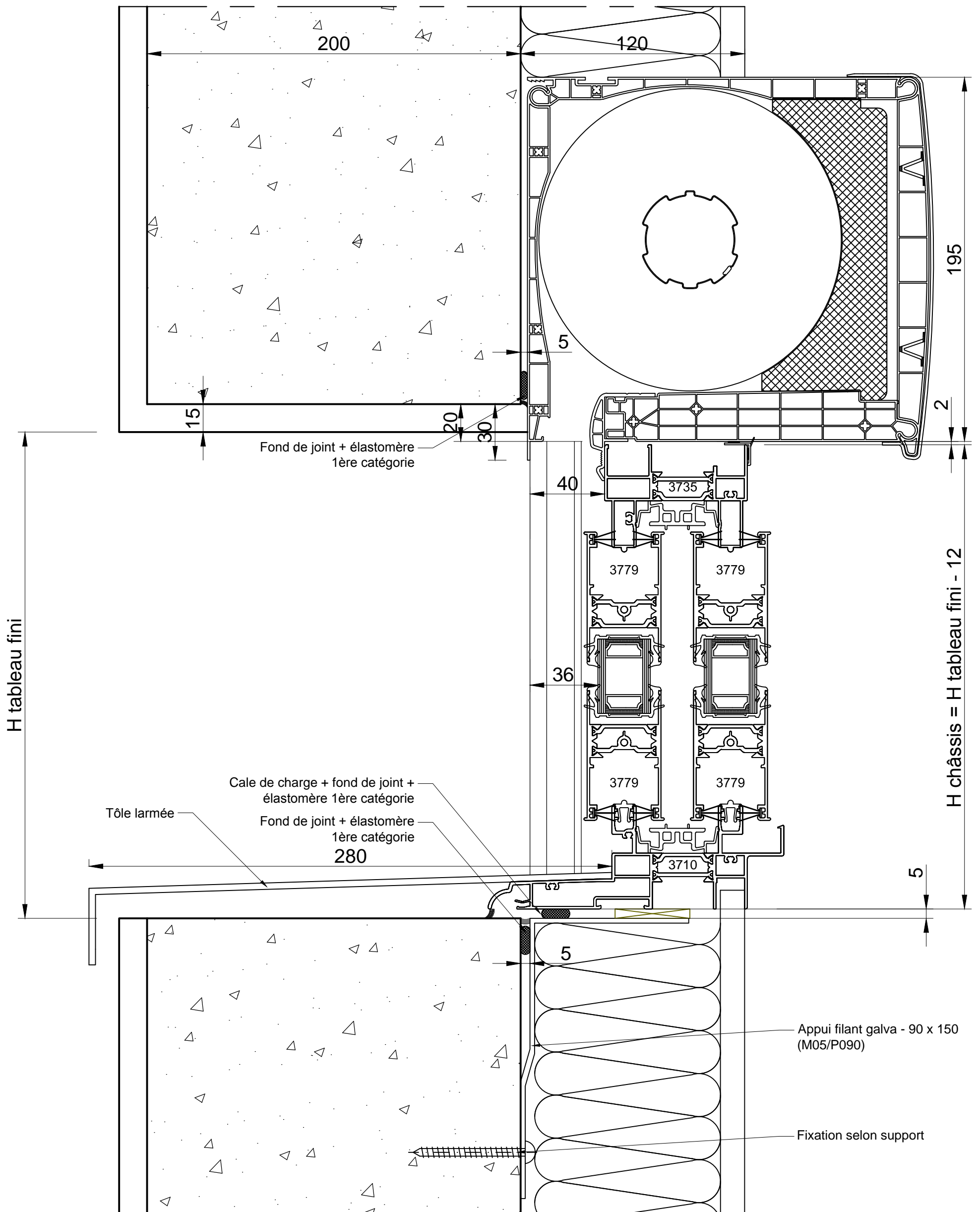

CATA TECH	Dessiné par E. TAVARES	Approuvé par N. BUERMANN	Coupe Verticale	Modifié le 11/02/2020	Date 28/11/2018	Echelle 1/2 - A3
 Fabricant de Fenêtres et Portes.			APPLIQUE RATTRAPAGE ISO 120			
			MISE EN OEUVRE CD	Edition C	Feuille No. ALU 33	

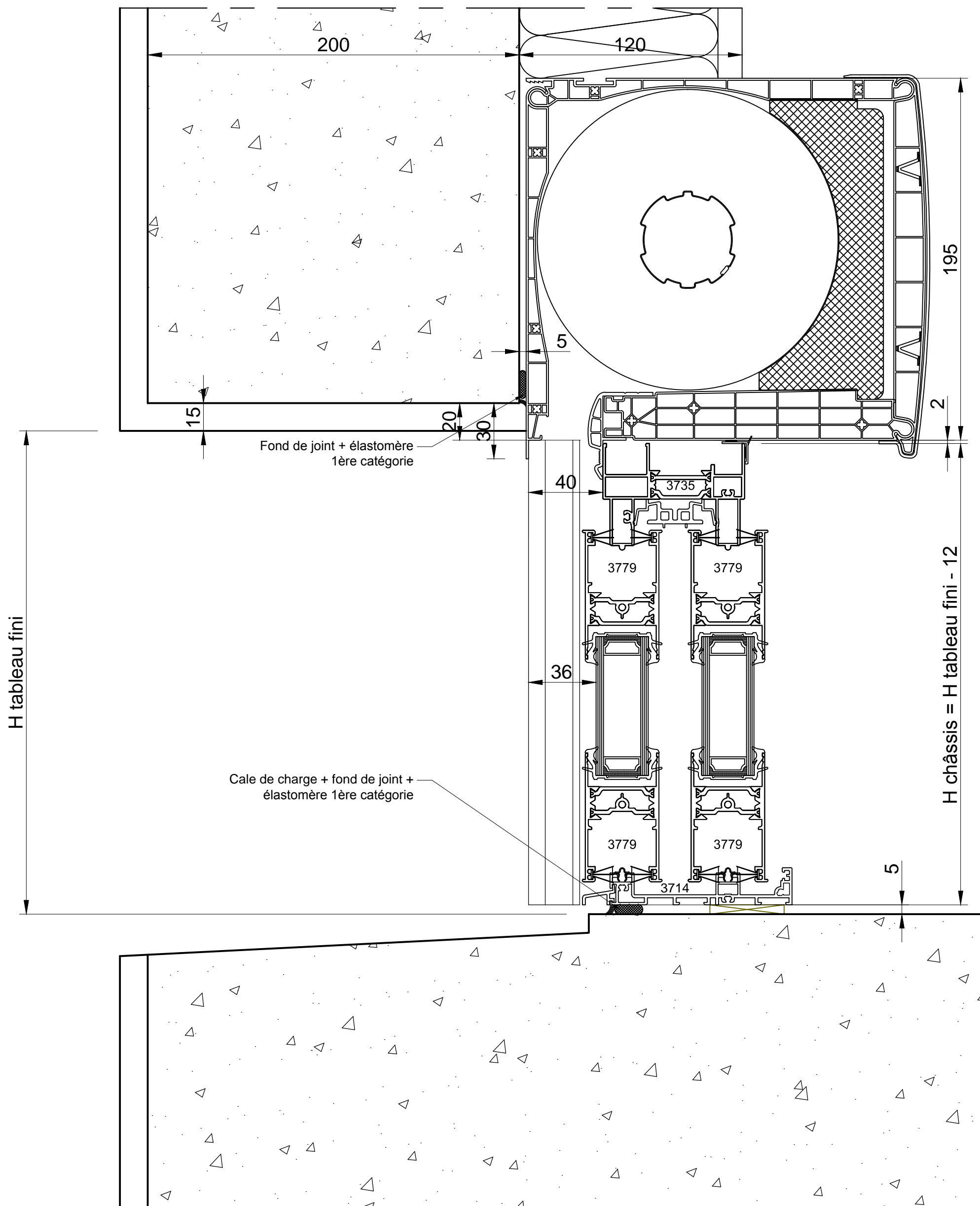

CATA TECH	Dessiné par E. TAVARES	Approuvé par N. BUERMANN	Coupe Verticale	Modifié le 11/02/2020	Date 28/11/2018	Echelle 1/2 - A3
 Fabricant de Fenêtres et Portes.			APPLIQUE RATRAPAGE ISO 120			
			MISE EN OEUVRE	CD	Edition C	Feuille No. ALU 34

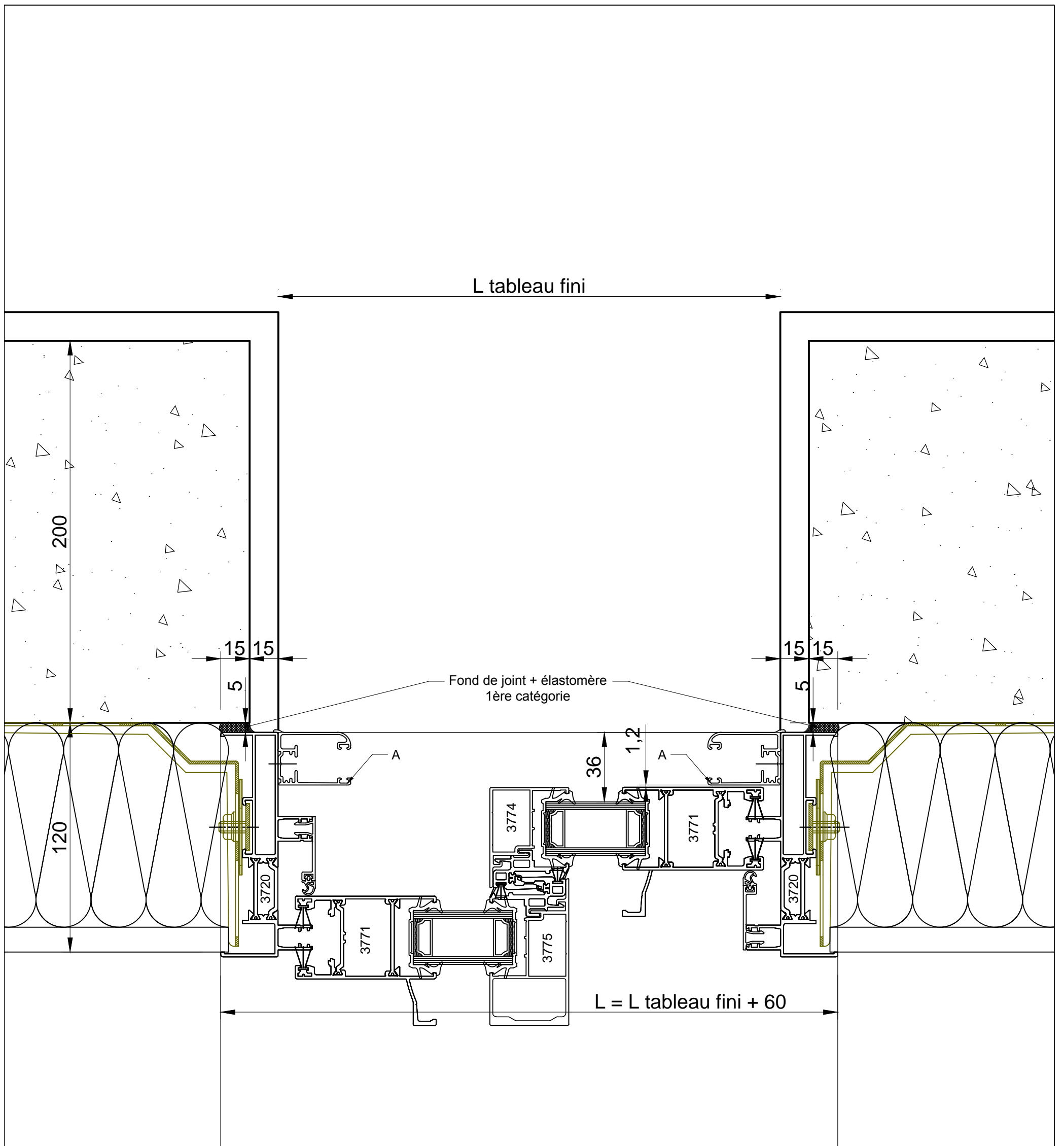

CATA TECH	Dessiné par E. TAVARES	Approuvé par N. BUERMANN	Coupe Horizontale	Modifié le 11/02/2020	Date 28/11/2018	Echelle 1/2 - A3
 Fabricant de Fenêtres et Portes.			APPLIQUE RATTRAPAGE ISO 120			
			MISE EN OEUVRE	CD	Edition C	Feuille No. ALU 35

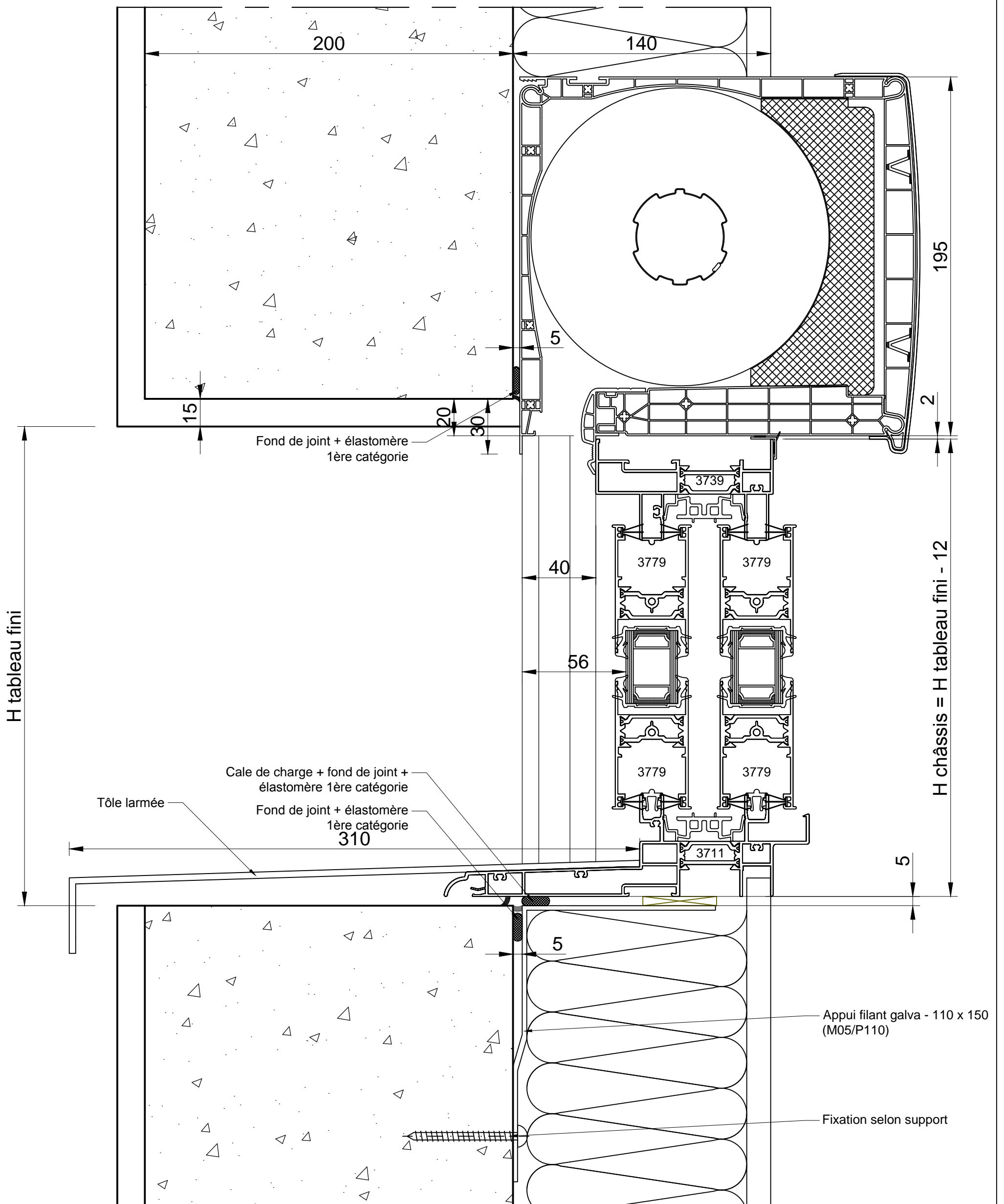

CATA TECH	Dessiné par E. TAVARES	Approuvé par N. BUERMANN	Coupe Verticale	Modifié le 11/02/2020	Date 28/11/2018	Echelle 1/2 - A3
 Fabricant de Fenêtres et Portes.			APPLIQUE RATTRAPAGE ISO 140			
			MISE EN OEUVRE	CD	Edition C	Feuille No. ALU 36

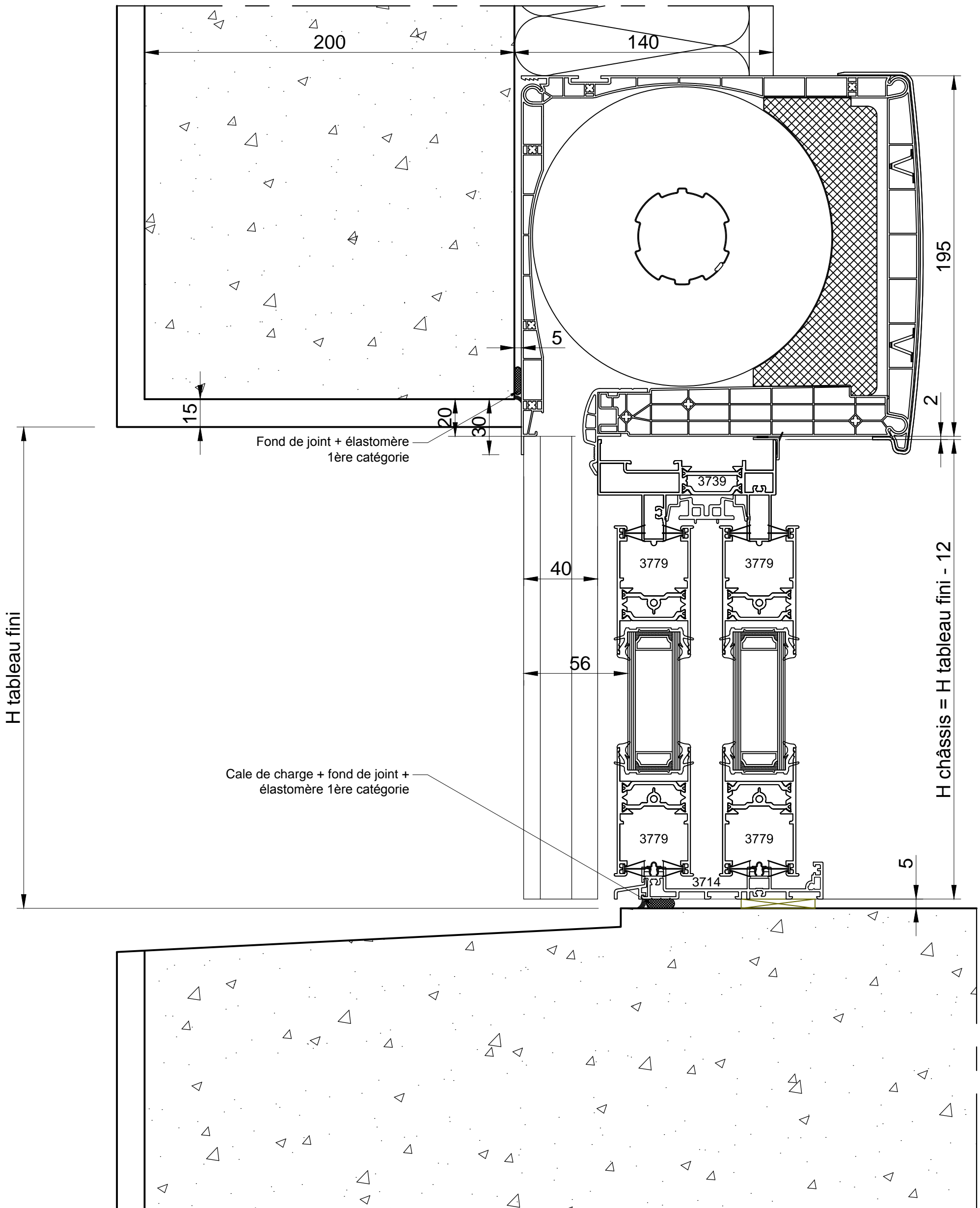

CATA TECH	Dessiné par E. TAVARES	Approuvé par N. BUERMANN	Coupe Verticale	Modifié le 11/02/2020	Date 28/11/2018	Echelle 1/2 - A3
 Fabricant de Fenêtres et Portes.			APPLIQUE RATTRAPAGE ISO 140			
			MISE EN OEUVRE	CD	Edition C	Feuille No. ALU 37

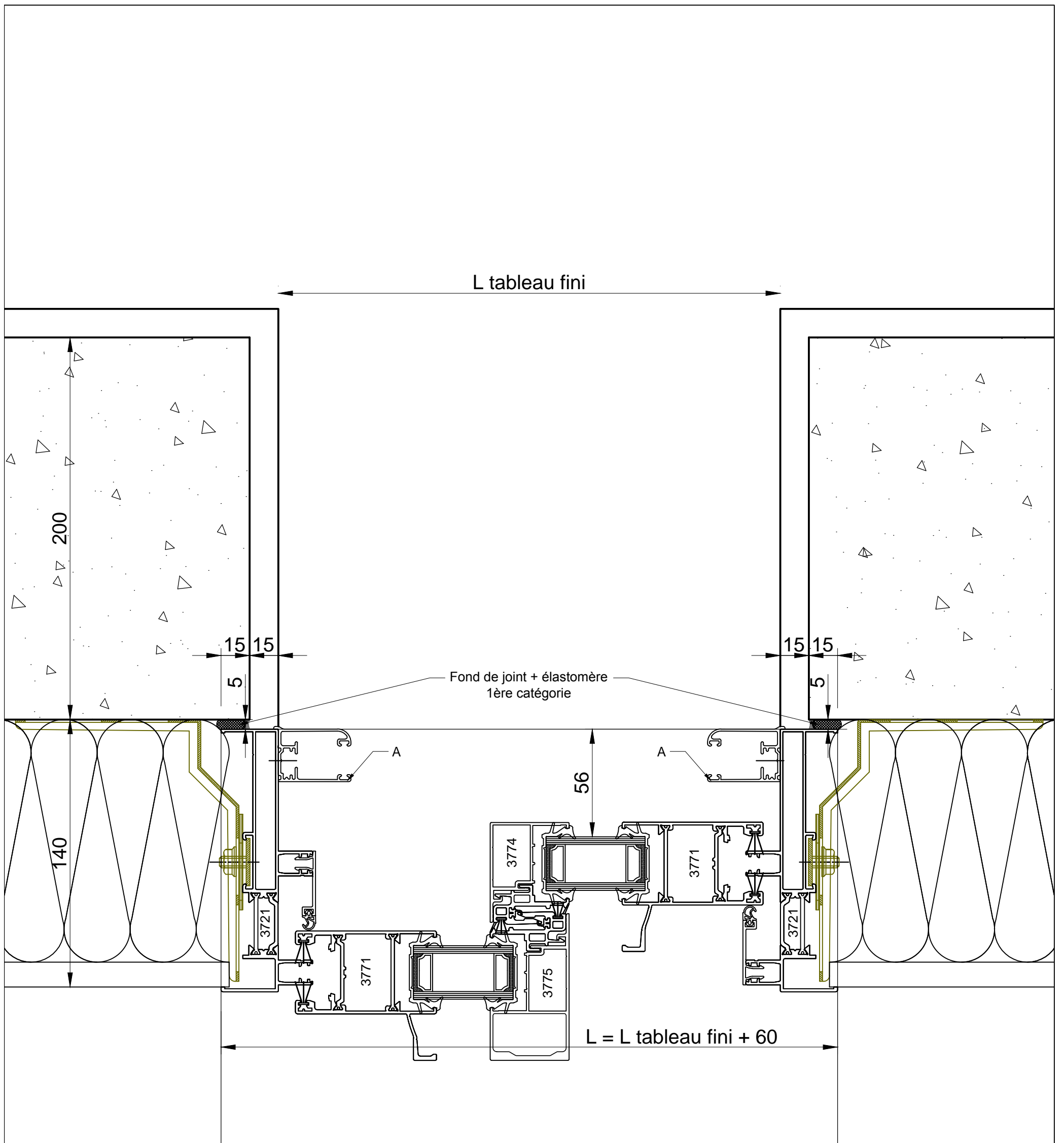

CATA TECH	Dessiné par E. TAVARES	Approuvé par N. BUERMANN	Coupe Horizontale	Modifié le 11/02/2020	Date 28/11/2018	Echelle 1/2 - A3
 Fabricant de Fenêtres et Portes.			APPLIQUE RATTRAPAGE ISO 140			
			MISE EN OEUVRE	CD	Edition C	Feuille No. ALU 38

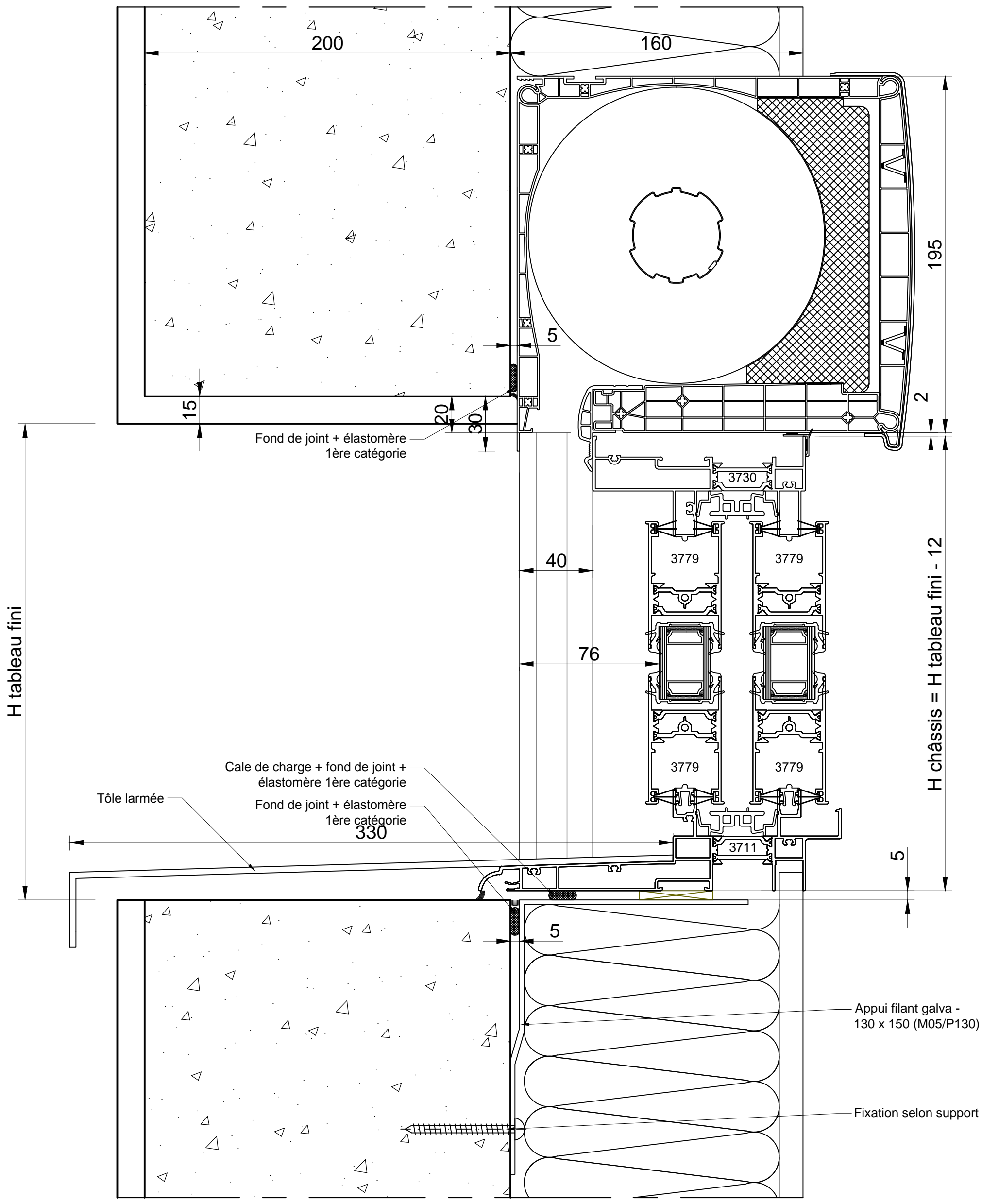

CATA TECH	Dessiné par E. TAVARES	Approuvé par N. BUERMANN	Coupe Verticale	Modifié le 11/02/2020	Date 28/11/2018	Echelle 1/2 - A3
 Fabricant de Fenêtres et Portes.			APPLIQUE RATRAPAGE ISO 160			
			MISE EN OEUVRE	CD	Edition C	Feuille No. ALU 39

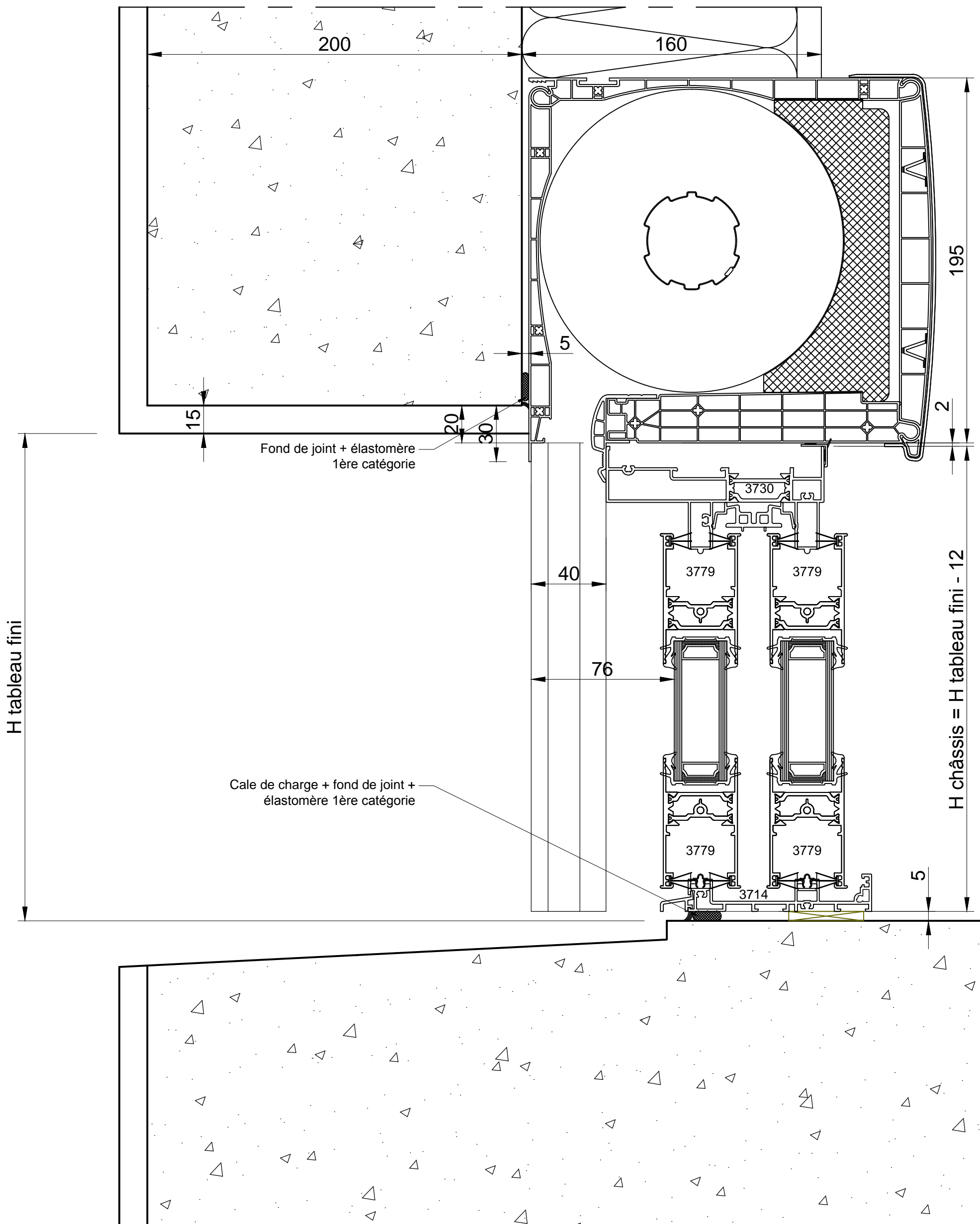

CATA TECH	Dessiné par E. TAVARES	Approuvé par N. BUERMANN	Coupe Verticale	Modifié le 11/02/2020	Date 28/11/2018	Echelle 1/2 - A3
 Fabricant de Fenêtres et Portes.			APPLIQUE RATTRAPAGE ISO 160			
			MISE EN OEUVRE	CD	Edition C	Feuille No. ALU 40

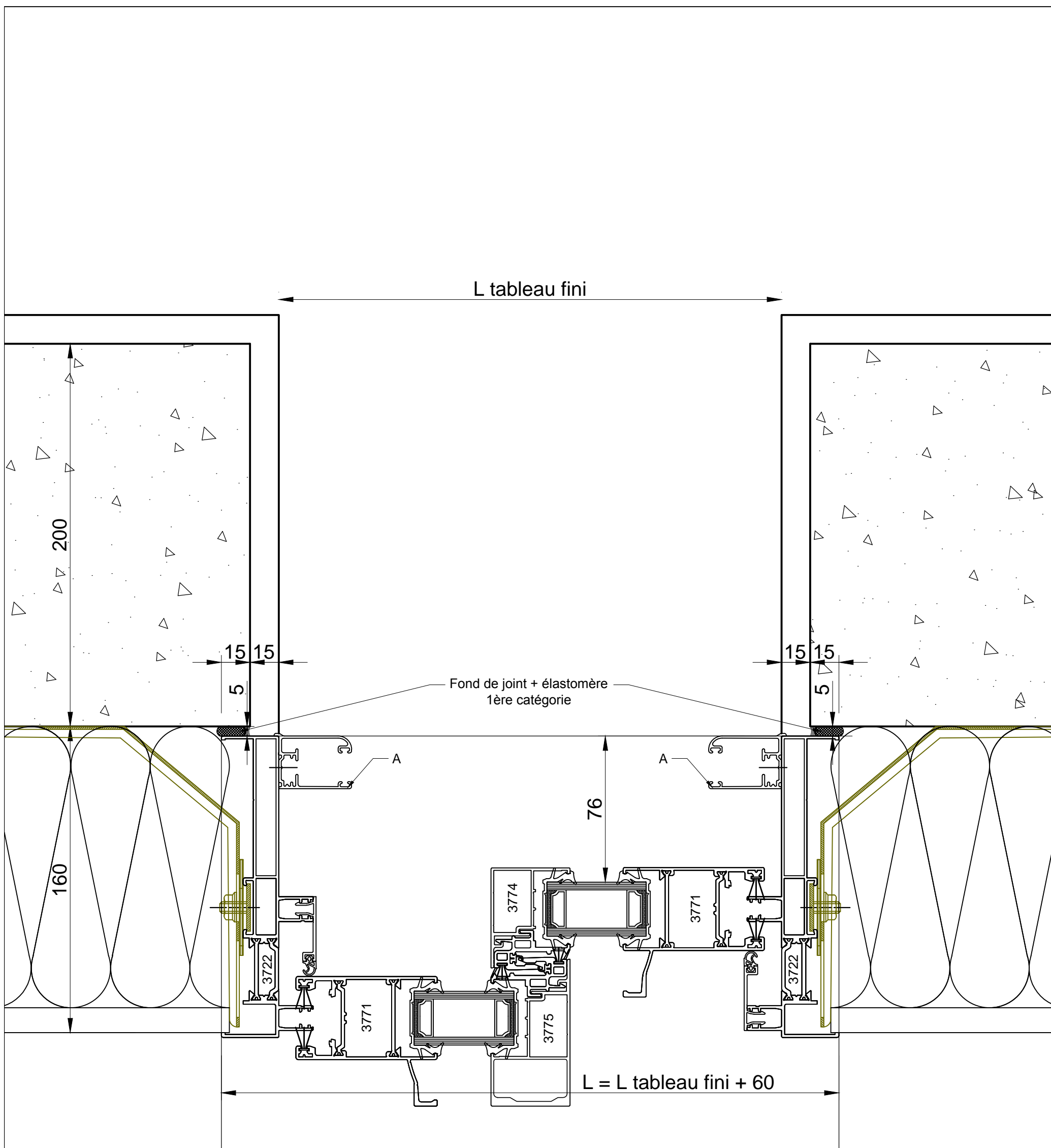

CATA TECH	Dessiné par E. TAVARES	Approuvé par N. BUERMANN	Coupe Horizontale	Modifié le 11/02/2020	Date 28/11/2018	Echelle 1/2 - A3
 Fabricant de Fenêtres et Portes.			APPLIQUE RATTRAPAGE ISO 160			
			MISE EN OEUVRE	CD	Edition C	Feuille No. ALU 41

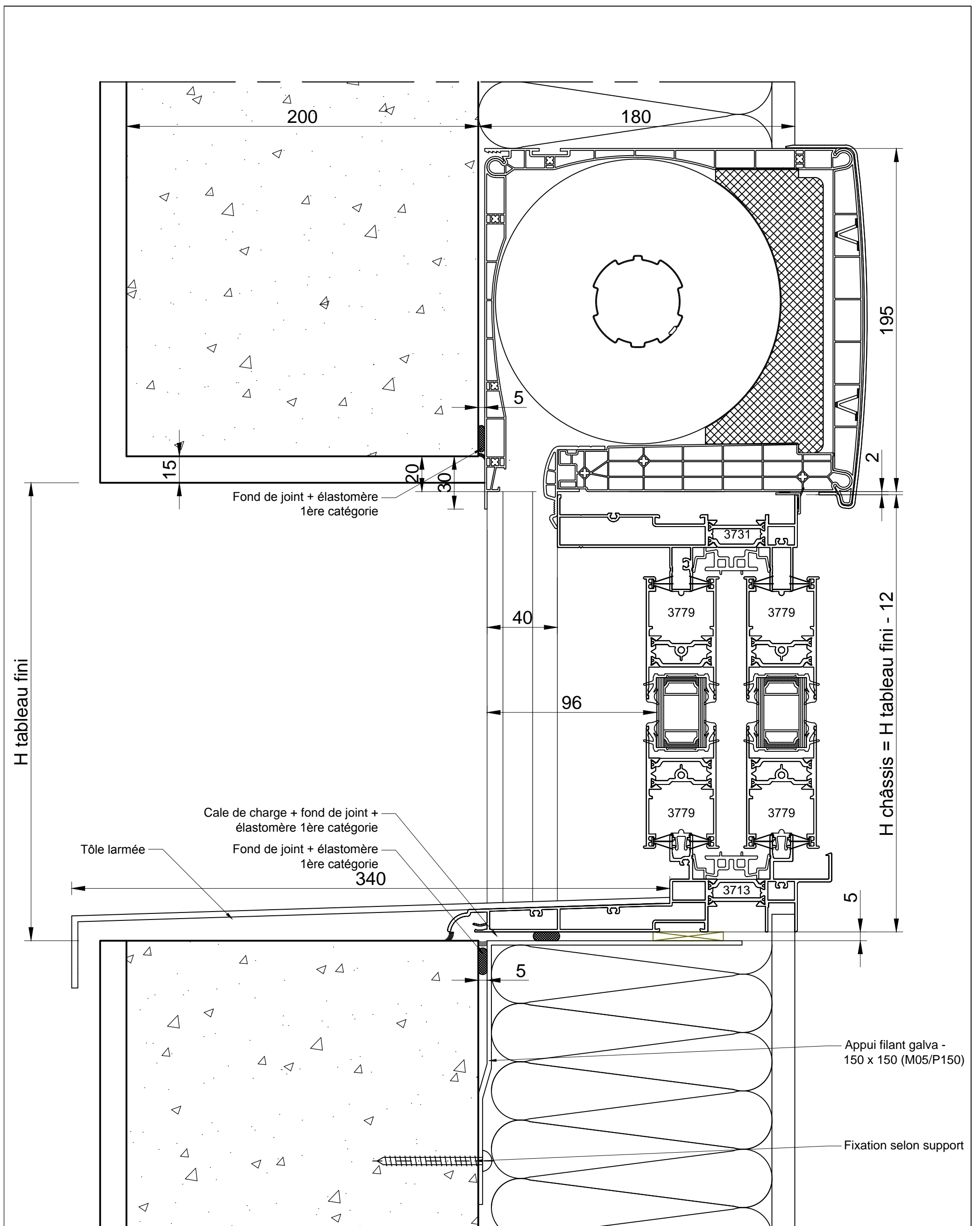

CATA TECH	Dessiné par E. TAVARES	Approuvé par N. BUERMANN	Coupe Verticale	Modifié le 11/02/2020	Date 28/11/2018	Echelle 1/2 - A3
 <p>Fabricant de Fenêtres et Portes.</p>			APPLIQUE RATRAPAGE ISO 180			
			MISE EN OEUVRE	CD	Edition C	Feuille No. ALU 42

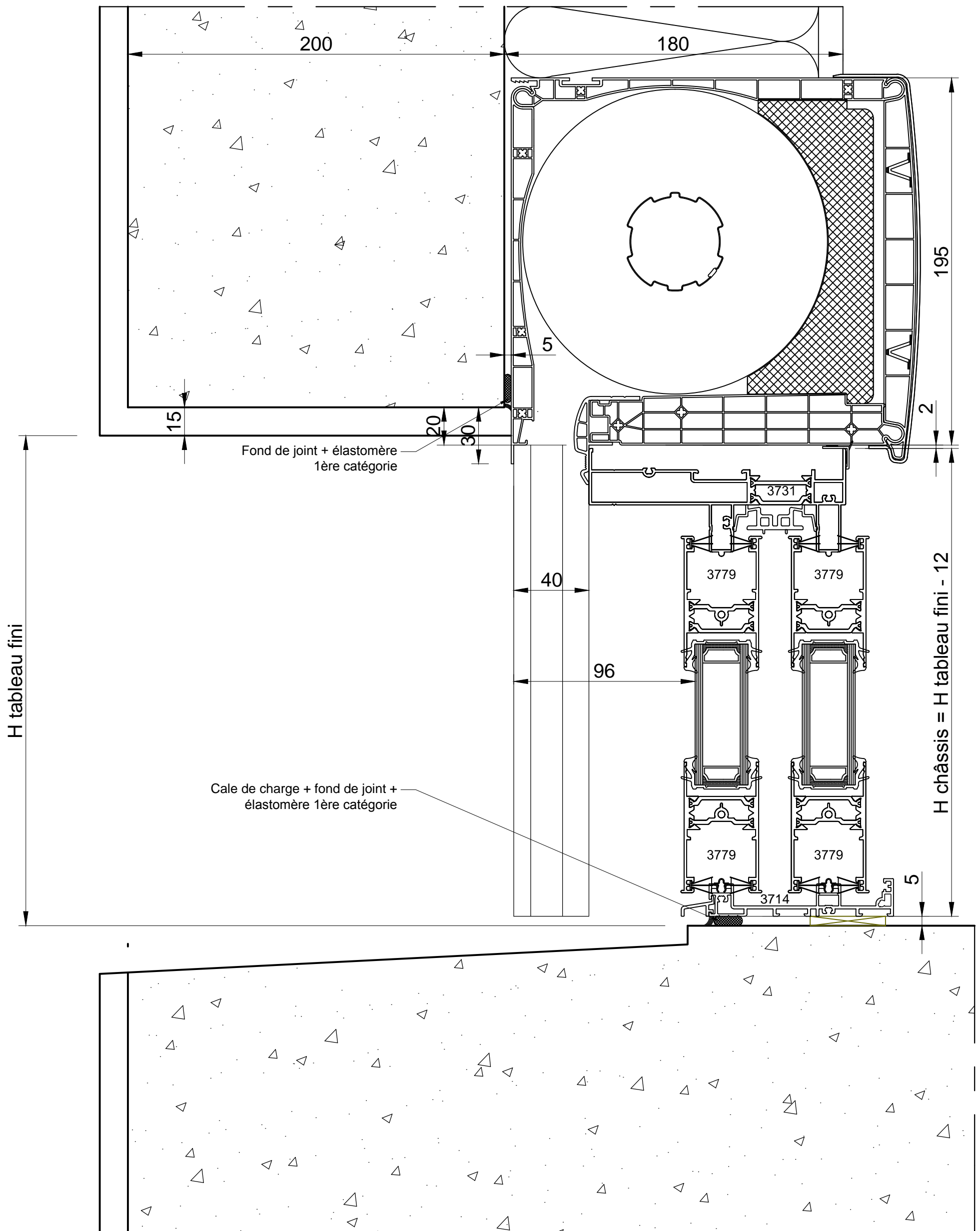

CATA TECH	Dessiné par E. TAVARES	Approuvé par N. BUERMANN	Coupe Verticale	Modifié le 11/02/2020	Date 28/11/2018	Echelle 1/2 - A3
 Fabricant de Fenêtres et Portes.			APPLIQUE RATTRAPAGE ISO 180			
			MISE EN OEUVRE	CD	Edition C	Feuille No. ALU 43

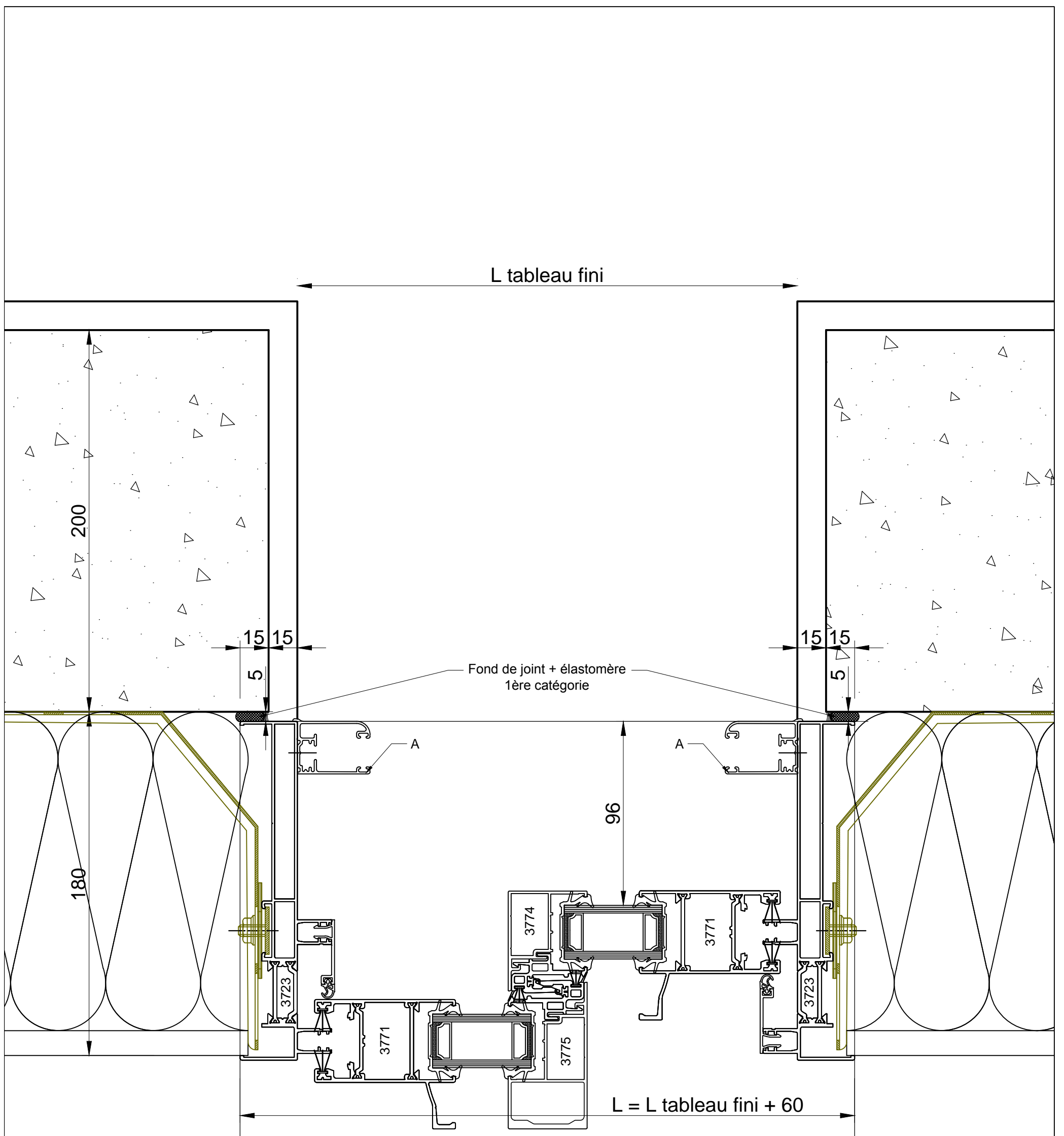

CATA TECH	Dessiné par E. TAVARES	Approuvé par N. BUERMANN	Coupe Horizontale	Modifié le 11/02/2020	Date 28/11/2018	Echelle 1/2 - A3
 Fabricant de Fenêtres et Portes.			APPLIQUE RATTRAPAGE ISO 180			
			MISE EN OEUVRE	CD	Edition C	Feuille No. ALU 44

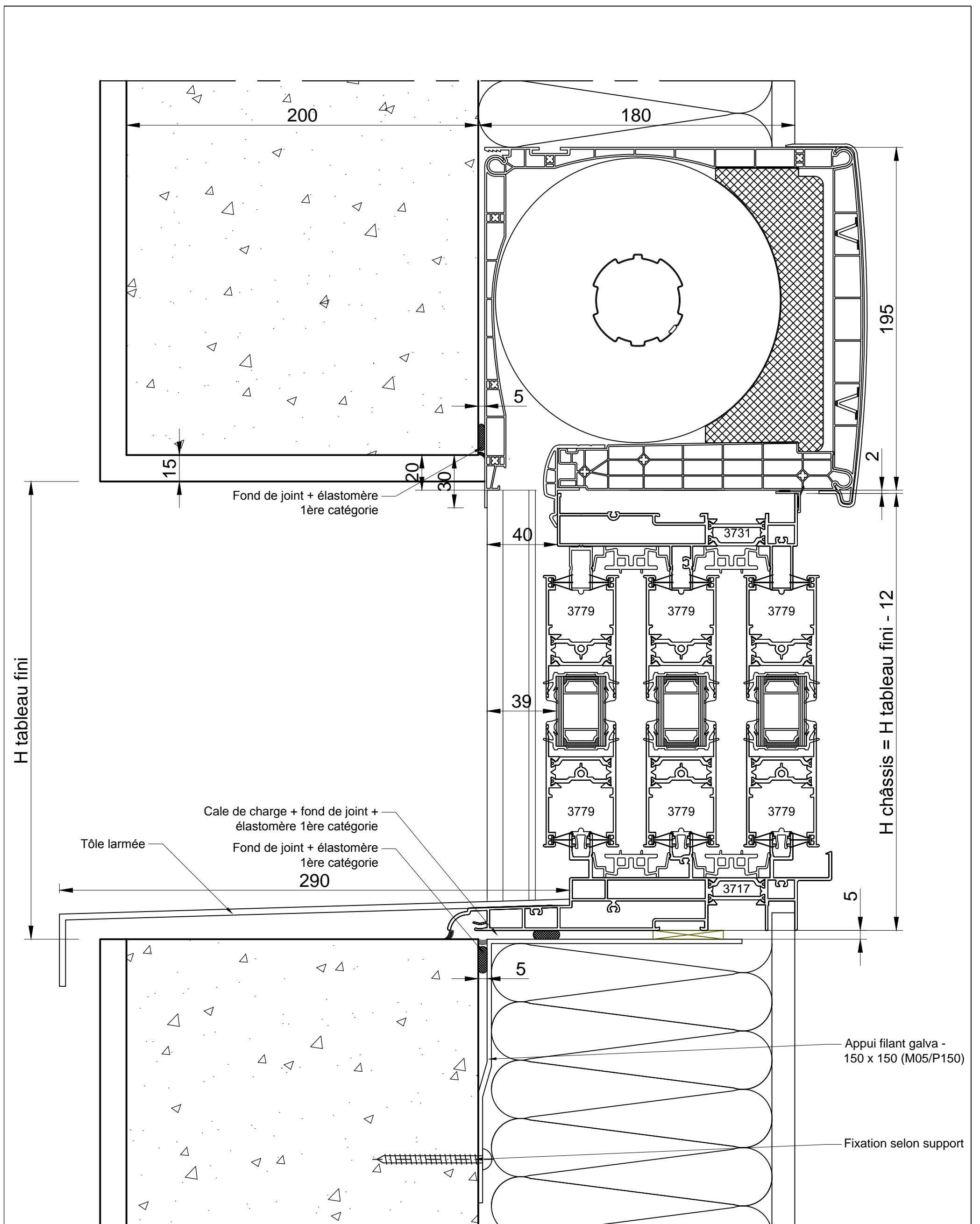

CATA TECH	Dessiné par E. TAVARES	Approuvé par N. BUERMANN	Coupe Verticale	Modifié le 11/02/2020	Date 28/11/2018	Echelle 1/2 - A3
 Fabricant de Fenêtres et Portes.		APPLIQUE RATTRAPAGE ISO 180				
		MISE EN OEUVRE	CD	Edition C	Feuille No. ALU 45	

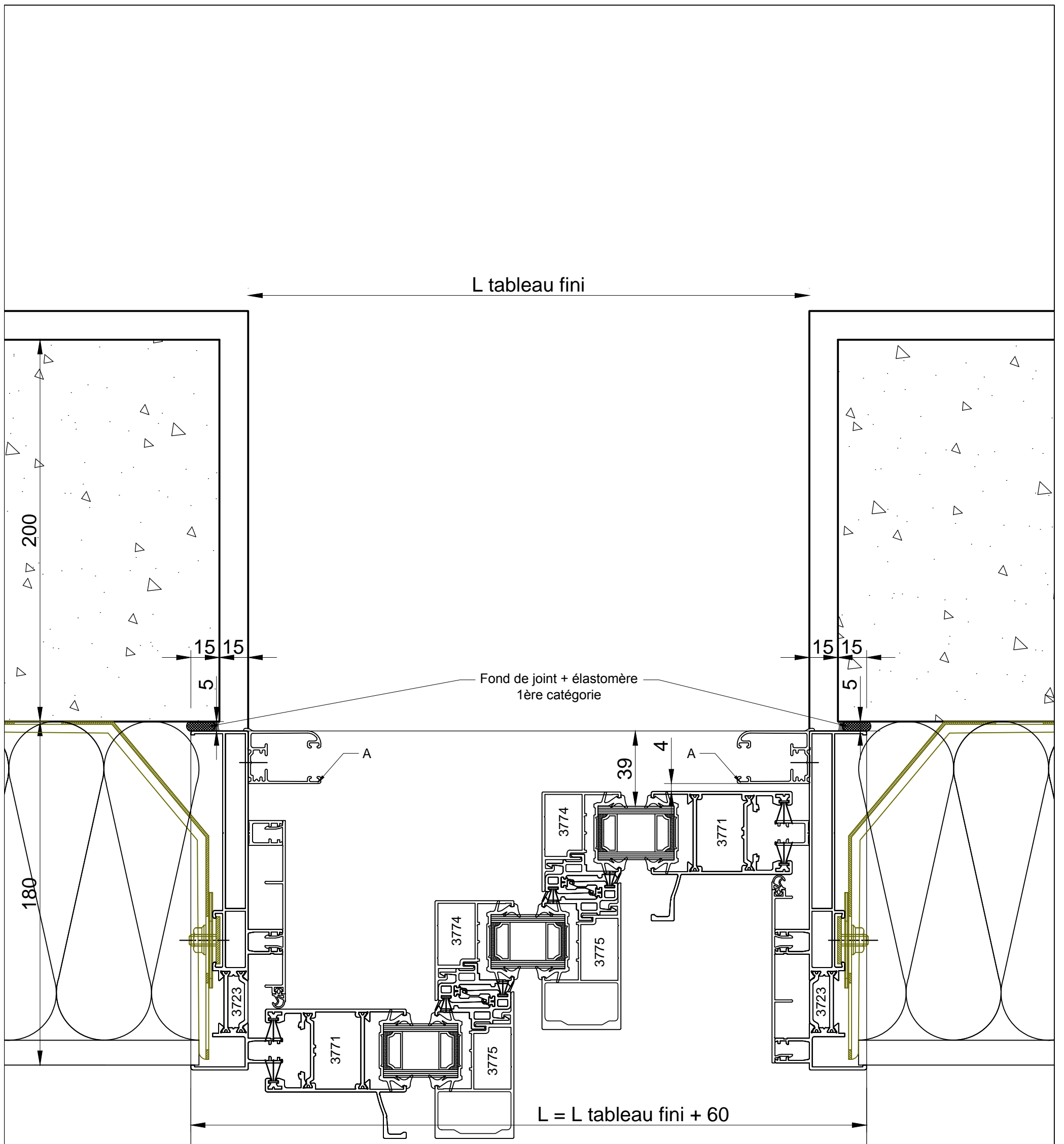

CATA TECH	Dessiné par E. TAVARES	Approuvé par N. BUERMANN	Coupe Horizontale	Modifié le 11/02/2020	Date 28/11/2018	Echelle 1/2 - A3
 Fabricant de Fenêtres et Portes.			APPLIQUE RATTRAPAGE ISO 180			
			MISE EN OEUVRE	CD	Edition C	Feuille No. ALU 46

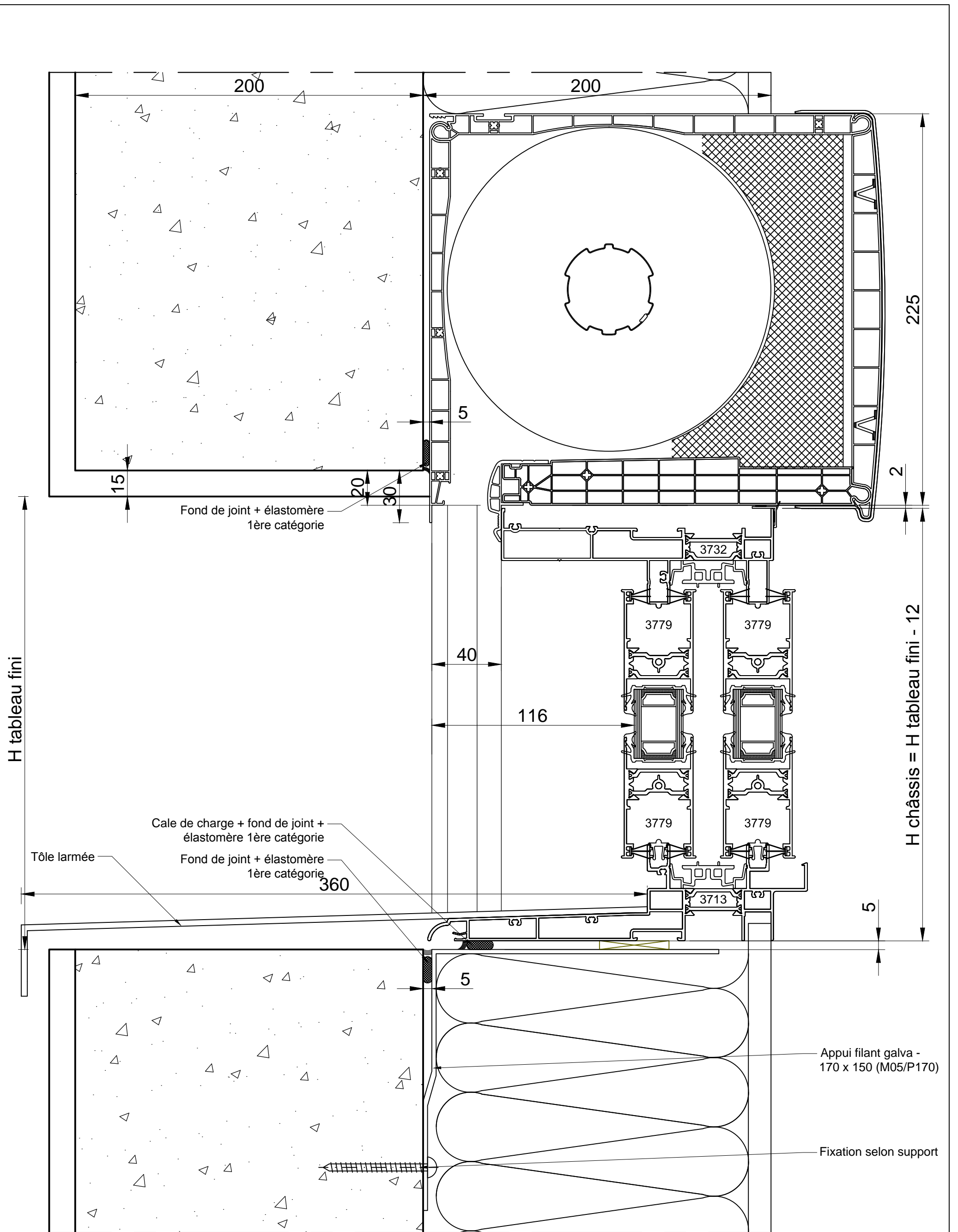

CATA TECH	Dessiné par E. TAVARES	Approuvé par N. BUERMANN	Coupe Verticale	Modifié le 11/02/2020	Date 28/11/2018	Echelle 1/2 - A3
 Fabricant de Fenêtres et Portes.			APPLIQUE RATRAPAGE ISO 200			
			MISE EN OEUVRE	CD	Edition C	Feuille No. ALU 47

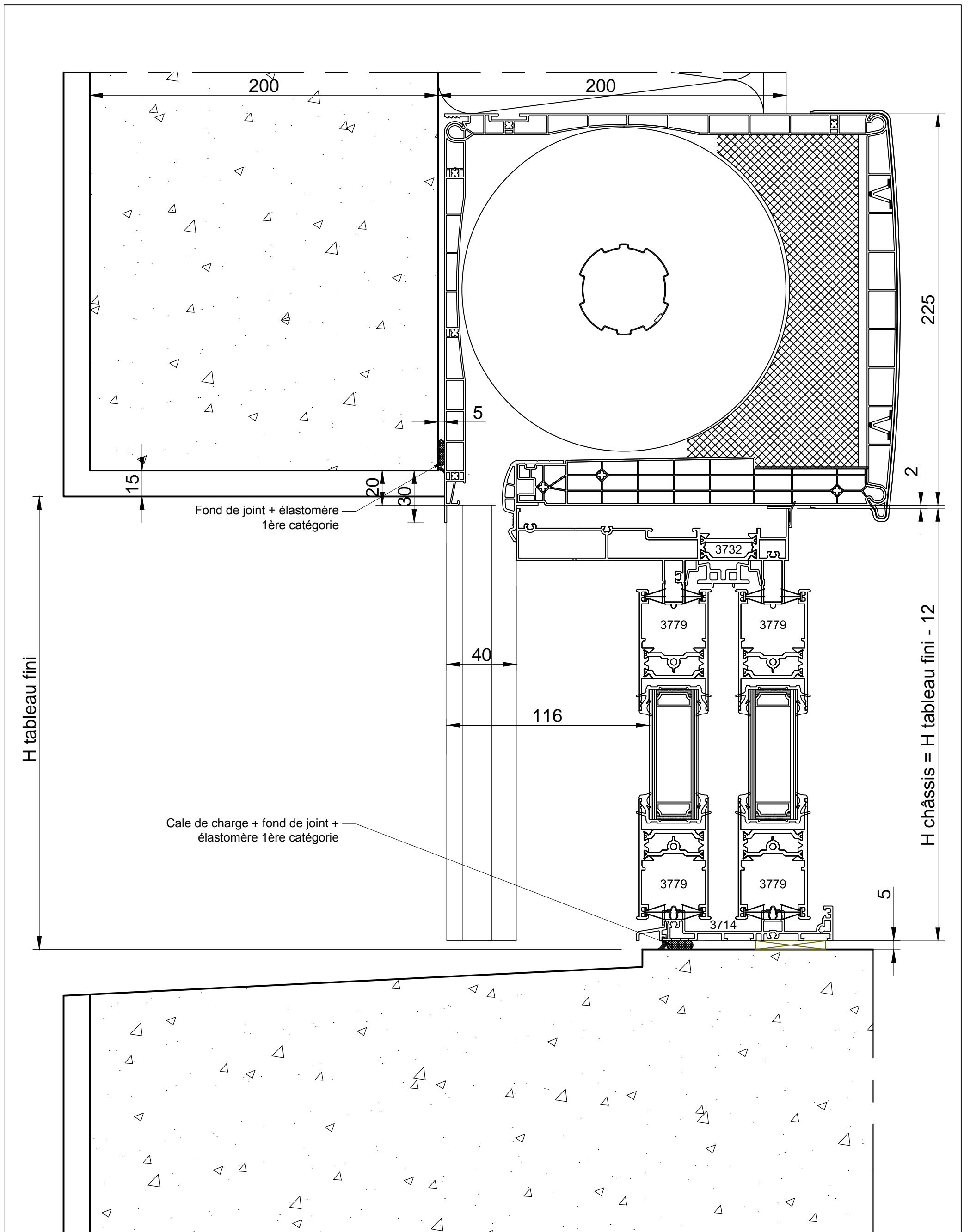

CATA TECH	Dessiné par E. TAVARES	Approuvé par N. BUERMANN	Coupe Verticale	Modifié le 11/02/2020	Date 28/11/2018	Echelle 1/2 - A3
 Fabricant de Fenêtres et Portes.			APPLIQUE RATTRAPAGE ISO 200			
			MISE EN OEUVRE	CD	Edition C	Feuille No. ALU 48

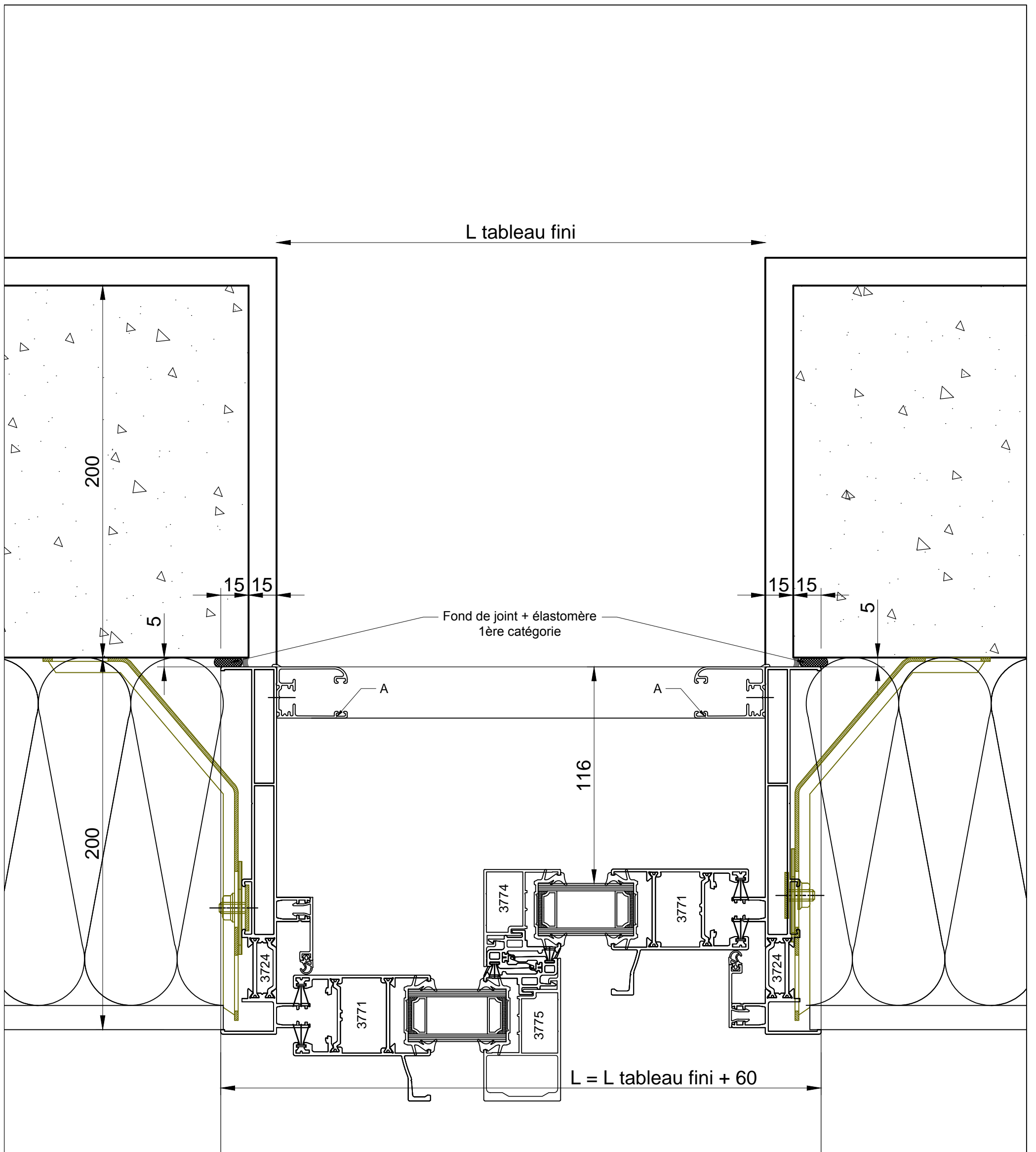

CATA TECH	Dessiné par E. TAVARES	Approuvé par N. BUERMANN	Coupe Horizontale	Modifié le 11/02/2020	Date 28/11/2018	Echelle 1/2 - A3
 Fabricant de Fenêtres et Portes.			APPLIQUE RATTRAPAGE ISO 200			
			MISE EN OEUVRE	CD	Edition C	Feuille No. ALU 49

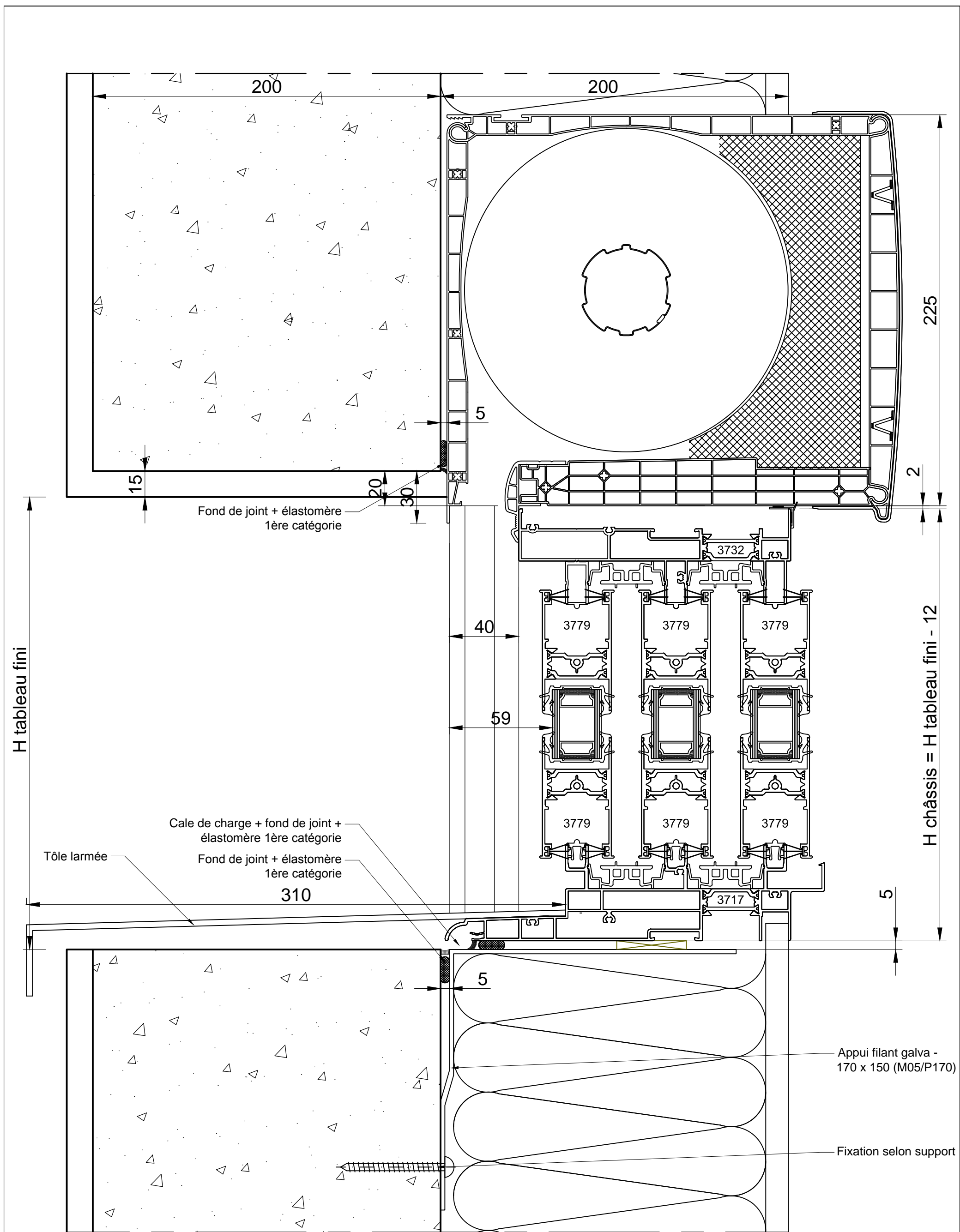

CATA TECH	Dessiné par E. TAVARES	Approuvé par N. BUERMANN	Coupe Verticale	Modifié le 11/02/2020	Date 28/11/2018	Echelle 1/2 - A3
 Fabricant de Fenêtres et Portes.			APPLIQUE RATTRAPAGE ISO 200			
			MISE EN OEUVRE	CD	Edition C	Feuille No. ALU 50

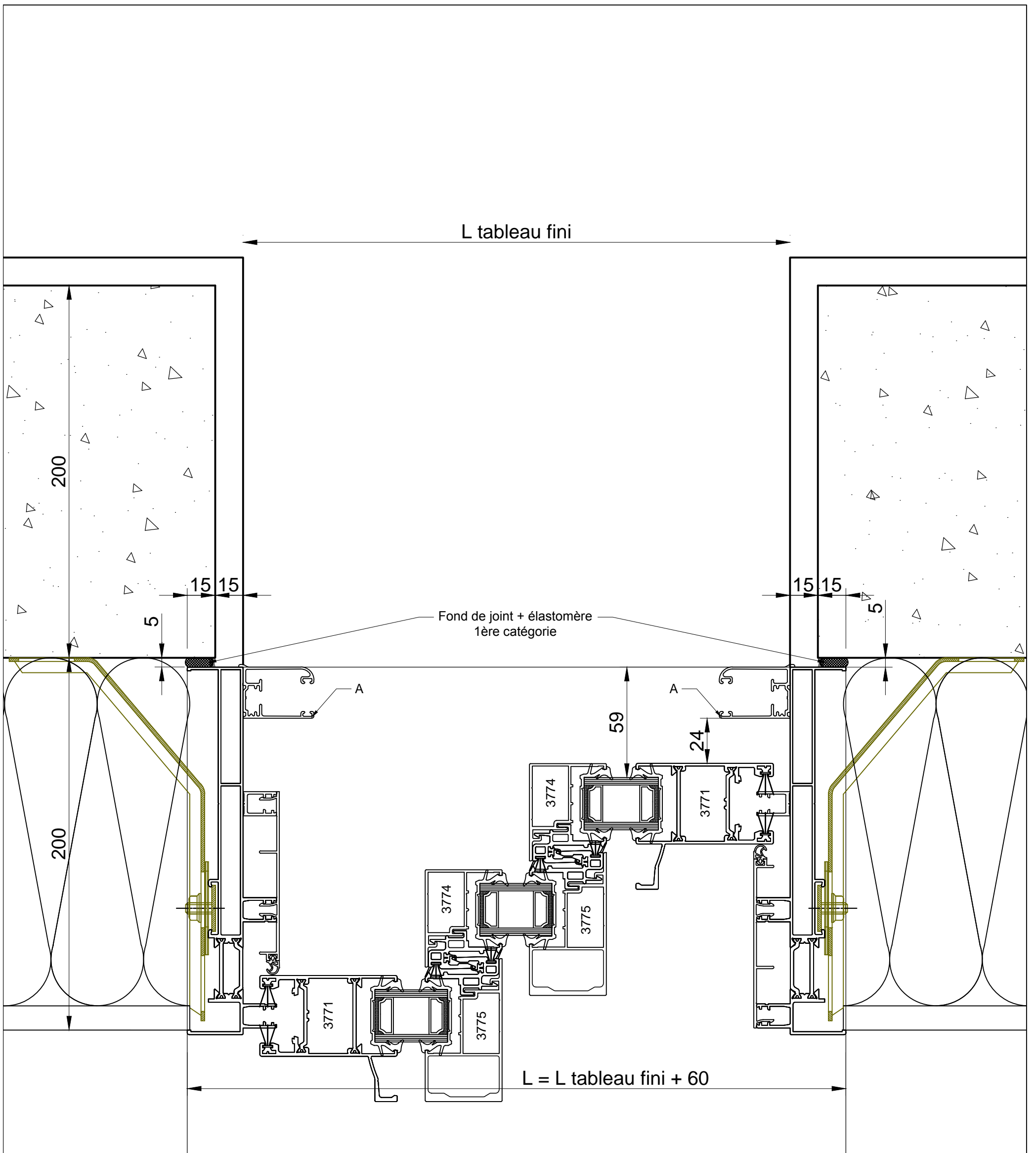

CATA TECH	Dessiné par E. TAVARES	Approuvé par N. BUERMANN	Coupe Horizontale	Modifié le 11/02/2020	Date 28/11/2018	Echelle 1/2 - A3
 Fabricant de Fenêtres et Portes.			APPLIQUE RATTRAPAGE ISO 200			
			MISE EN OEUVRE	CD	Edition C	Feuille No. ALU 51

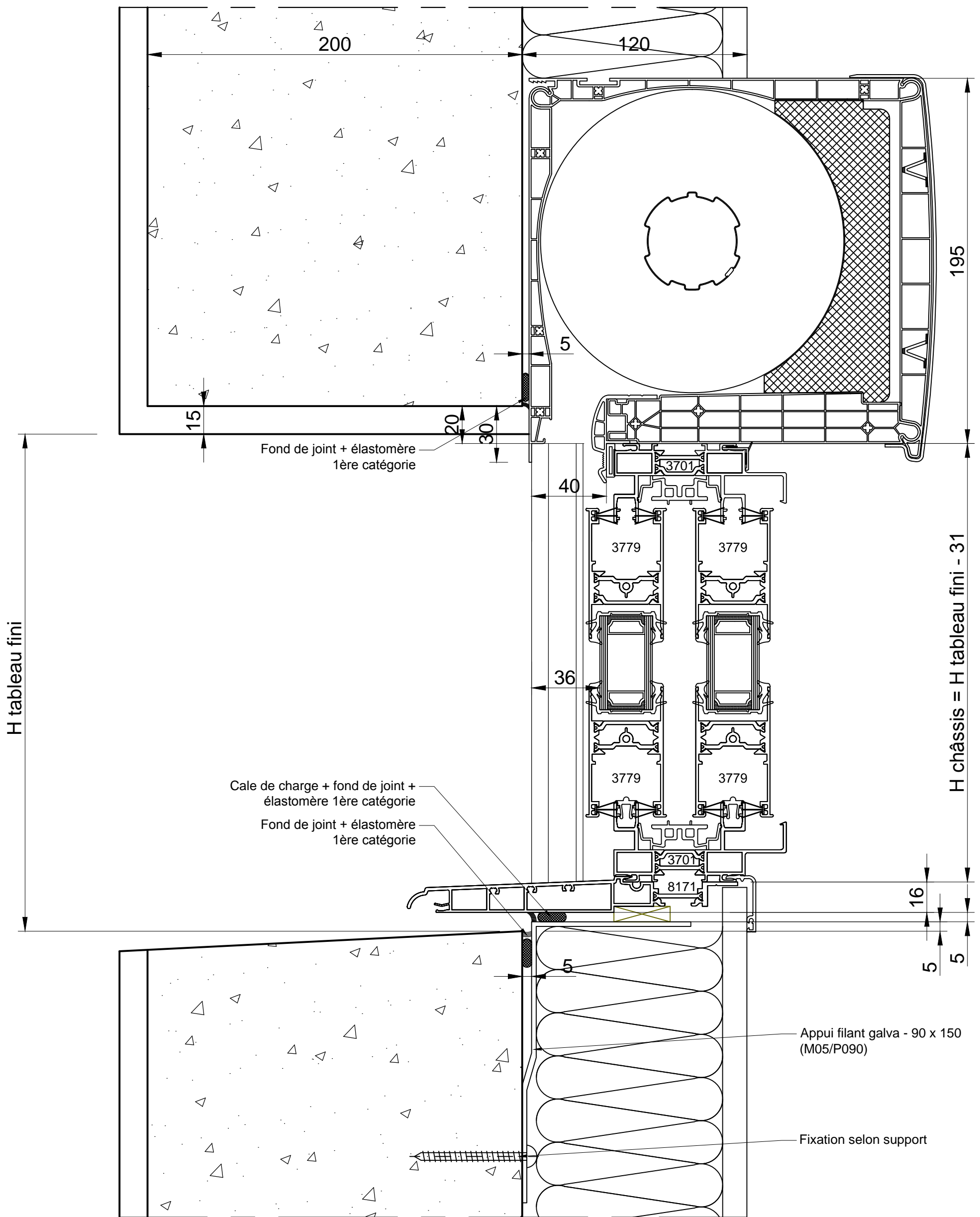

CATA TECH	Dessiné par E. TAVARES	Approuvé par N. BUERMANN	Coupe Verticale	Modifié le 11/02/2020	Date 28/11/2018	Echelle 1/2 - A3
 Fabricant de Fenêtres et Portes.			APPLIQUE RATTRAPAGE ISO 120			
			MISE EN OEUVRE	CO	Edition C	Feuille No. ALU 52

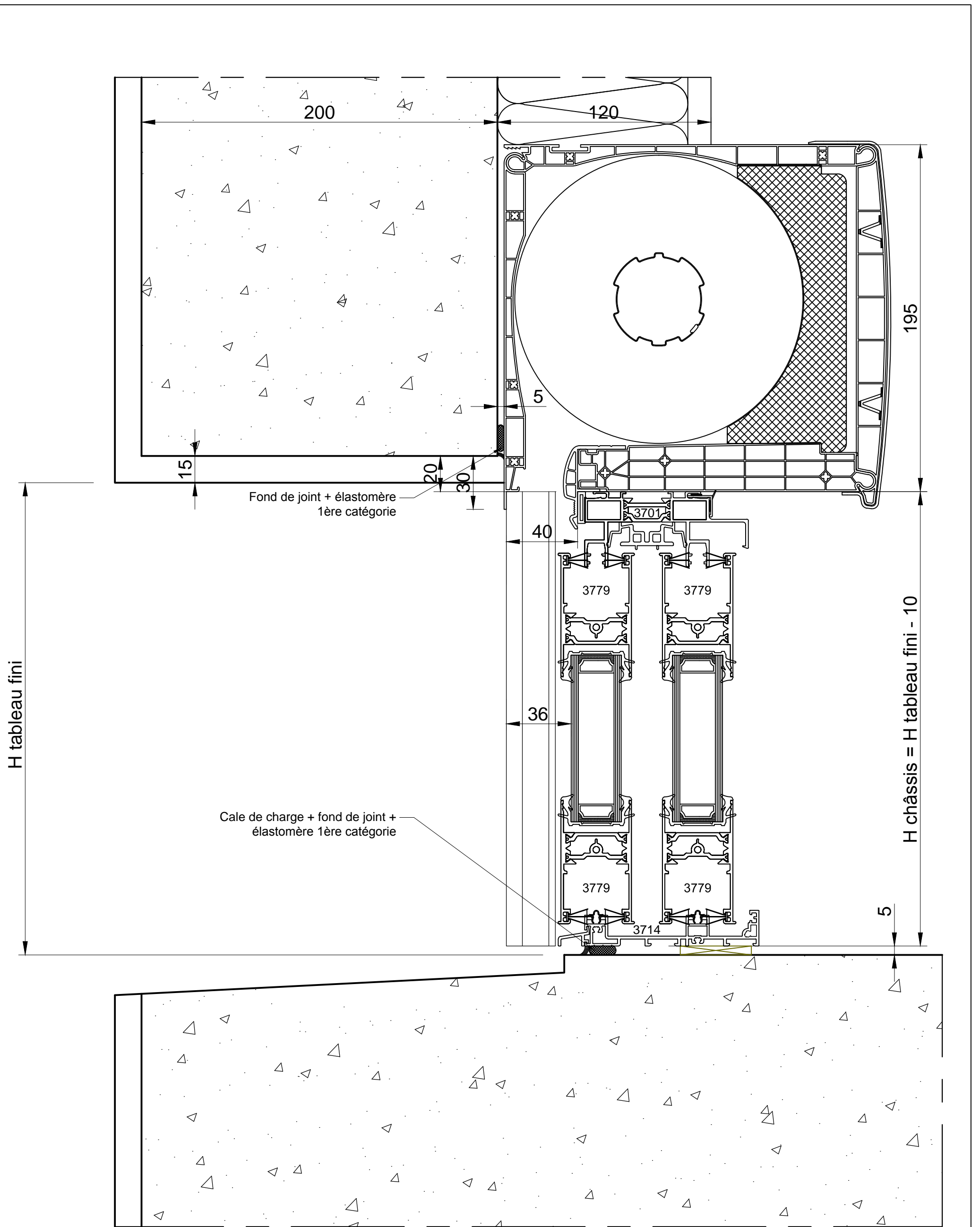

CATA TECH	Dessiné par E. TAVARES	Approuvé par N. BUERMANN	Coupe Verticale	Modifié le 11/02/2020	Date 28/11/2018	Echelle 1/2 - A3
 Fabricant de Fenêtres et Portes.			APPLIQUE RATTRAPAGE ISO 120			
			MISE EN OEUVRE	CO	Edition C	Feuille No. ALU 53

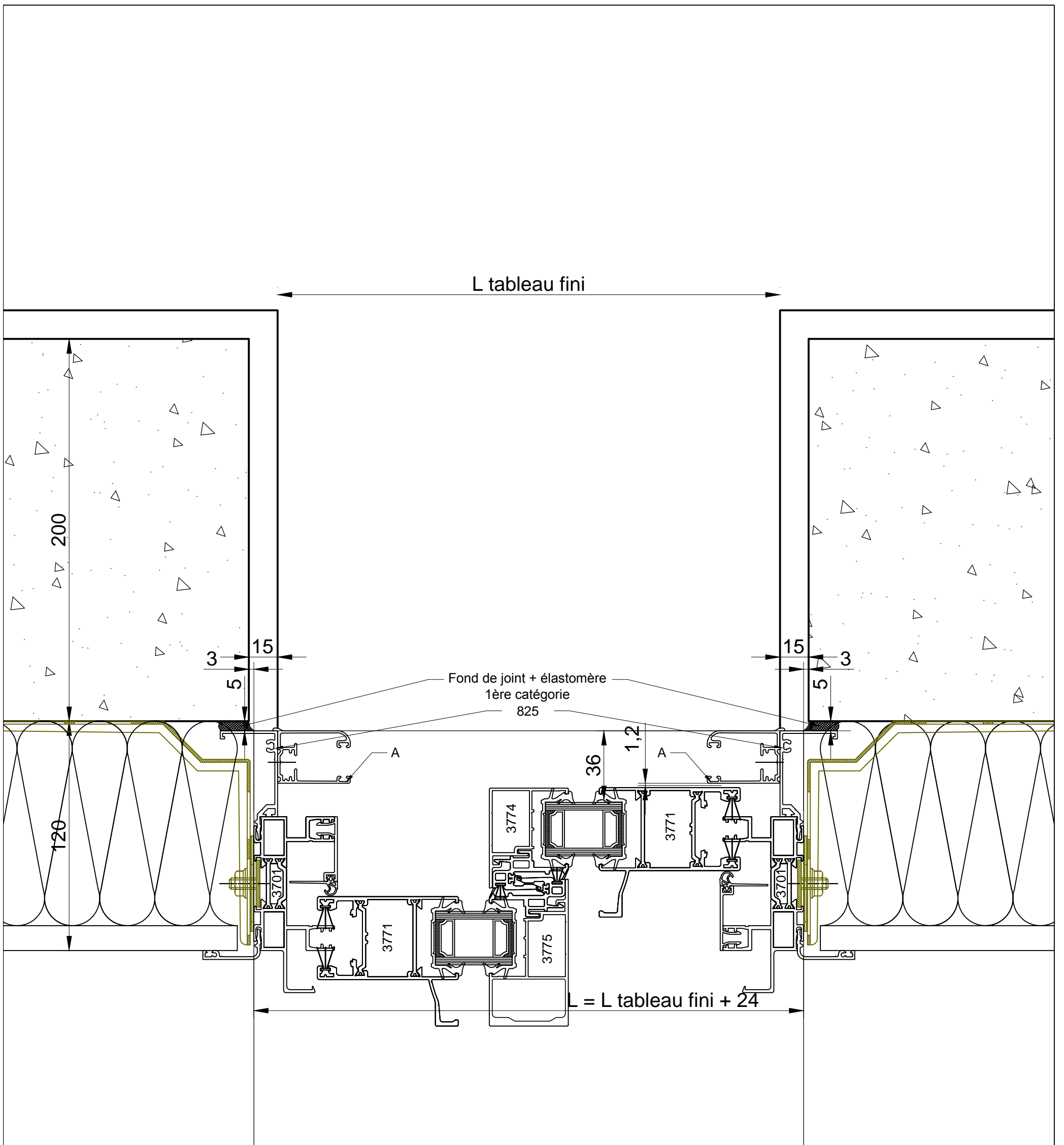

CATA TECH	Dessiné par E. TAVARES	Approuvé par N. BUERMANN	Coupe Horizontale	Modifié le 11/02/2020	Date 28/11/2018	Echelle 1/2 - A3
 Fabricant de Fenêtres et Portes.			APPLIQUE RATTRAPAGE ISO 120			
			MISE EN OEUVRE	CO	Edition C	Feuille No. ALU 54

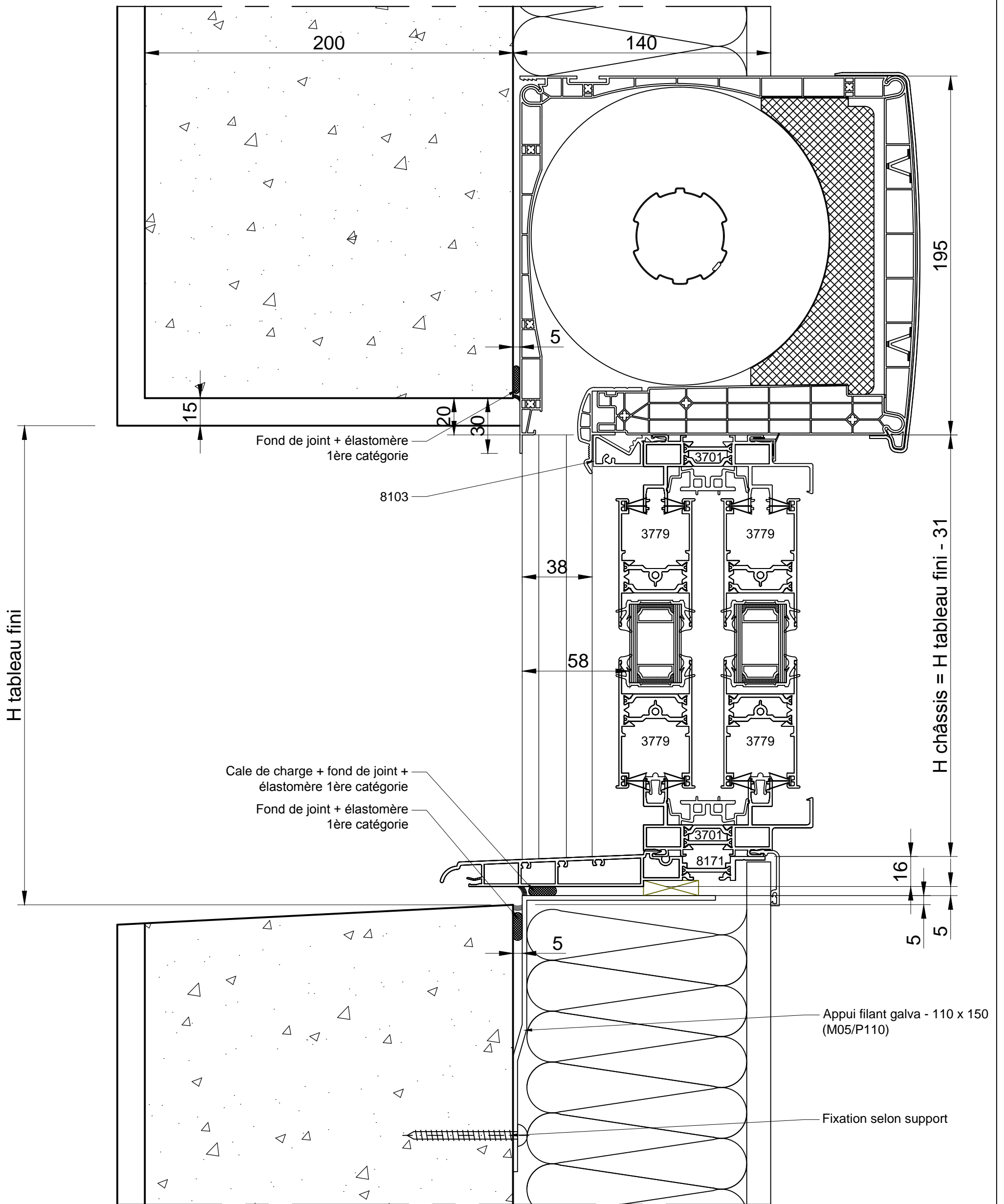

CATA TECH	Dessiné par E. TAVARES	Approuvé par N. BUERMANN	Coupe Verticale	Modifié le 11/02/2020	Date 28/11/2018	Echelle 1/2 - A3
 Fabricant de Fenêtres et Portes.			APPLIQUE RATTRAPAGE ISO 140			
			MISE EN OEUVRE	CO	Edition C	Feuille No. ALU 55

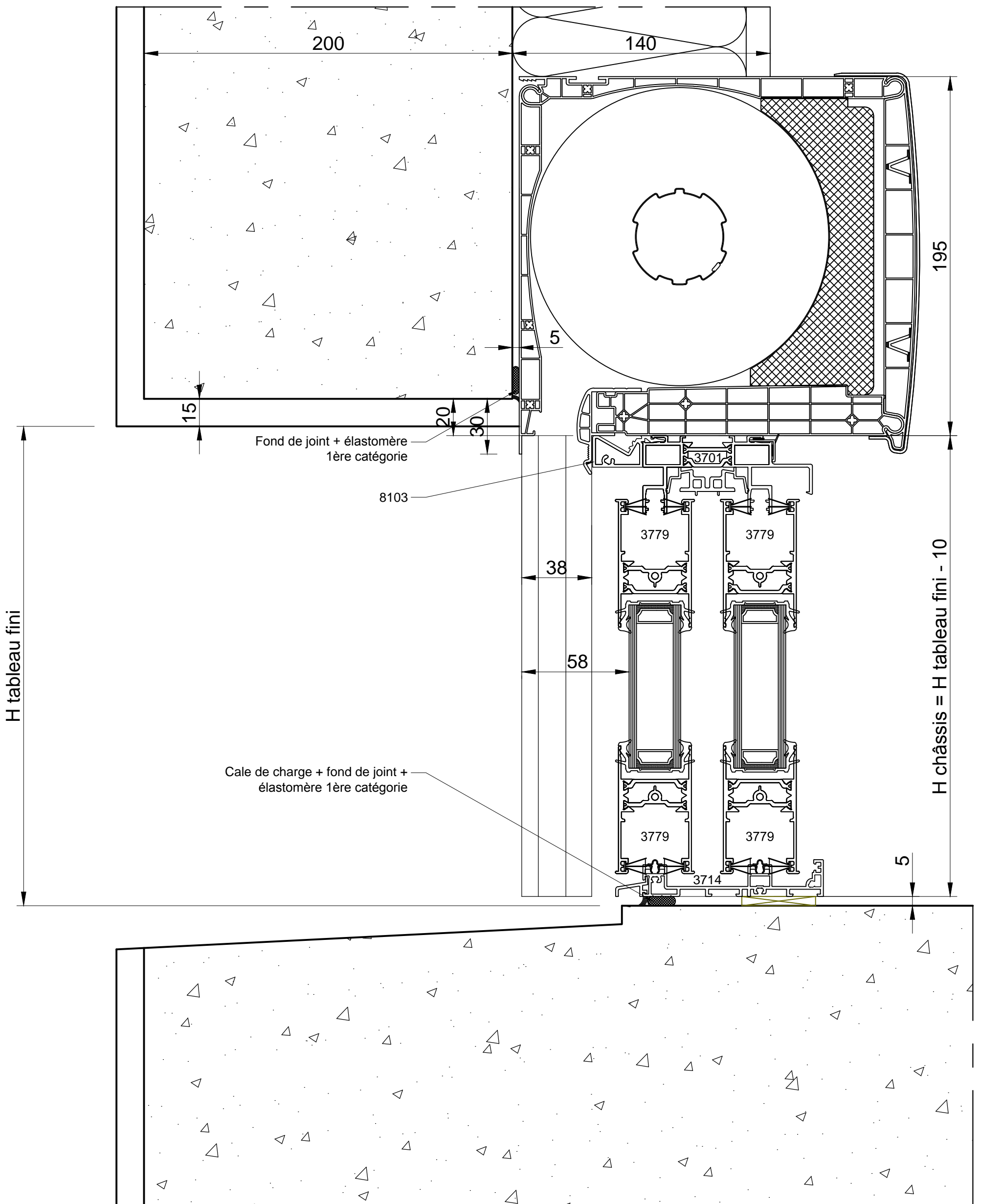

CATA TECH	Dessiné par E. TAVARES	Approuvé par N. BUERMANN	Coupe Verticale	Modifié le 11/02/2020	Date 28/11/2018	Echelle 1/2 - A3
 <p>hilzinger Fabricant de Fenêtres et Portes.</p>			APPLIQUE RATTRAPAGE ISO 140			
			MISE EN OEUVRE	CO	Edition C	Feuille No. ALU 56

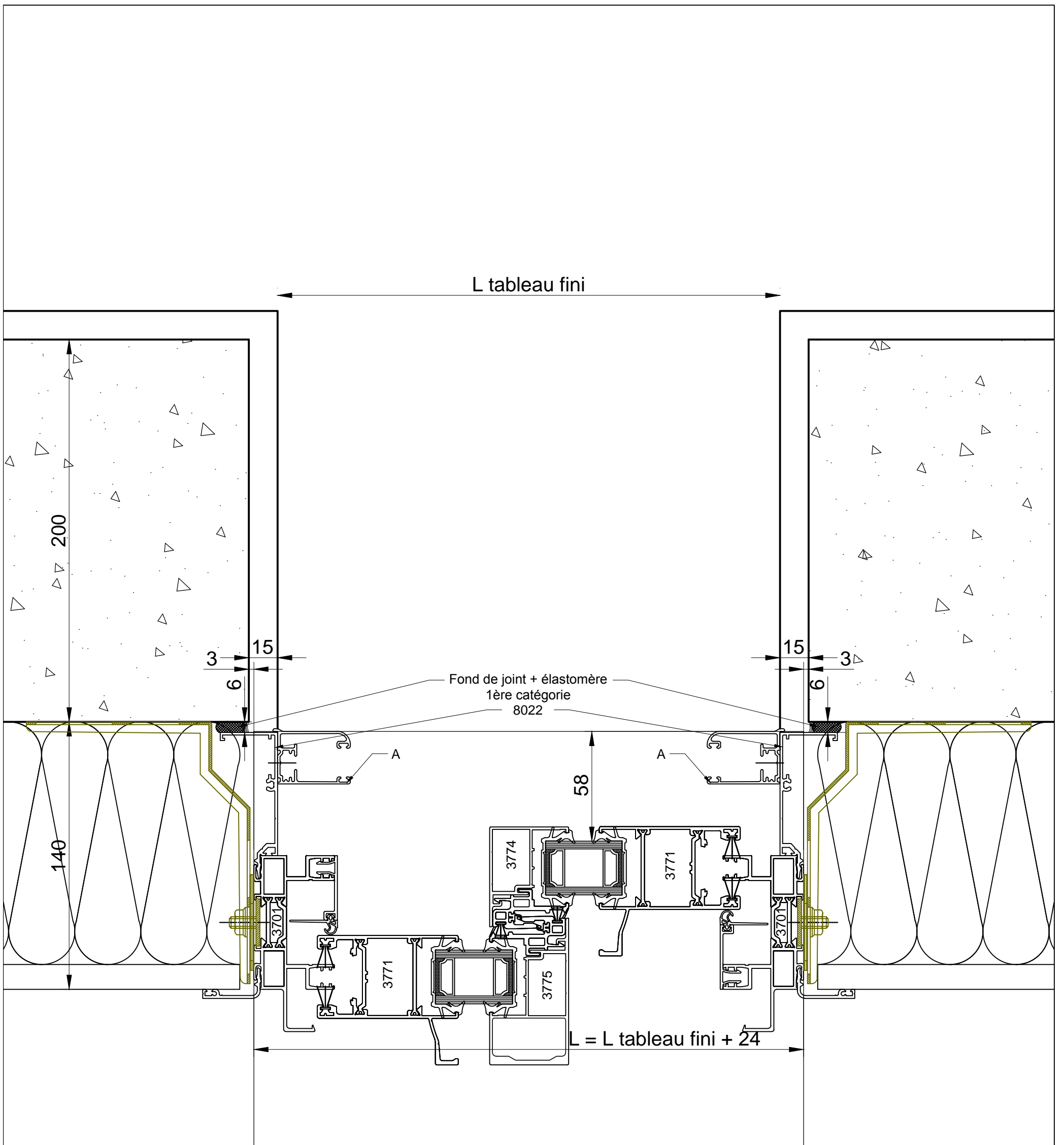

CATA TECH	Dessiné par E. TAVARES	Approuvé par N. BUERMANN	Coupe Horizontale	Modifié le 11/02/2020	Date 28/11/2018	Echelle 1/2 - A3
 Fabricant de Fenêtres et Portes.			APPLIQUE RATRAPAGE ISO 140			
			MISE EN OEUVRE	CO	Edition C	Feuille No. ALU 57

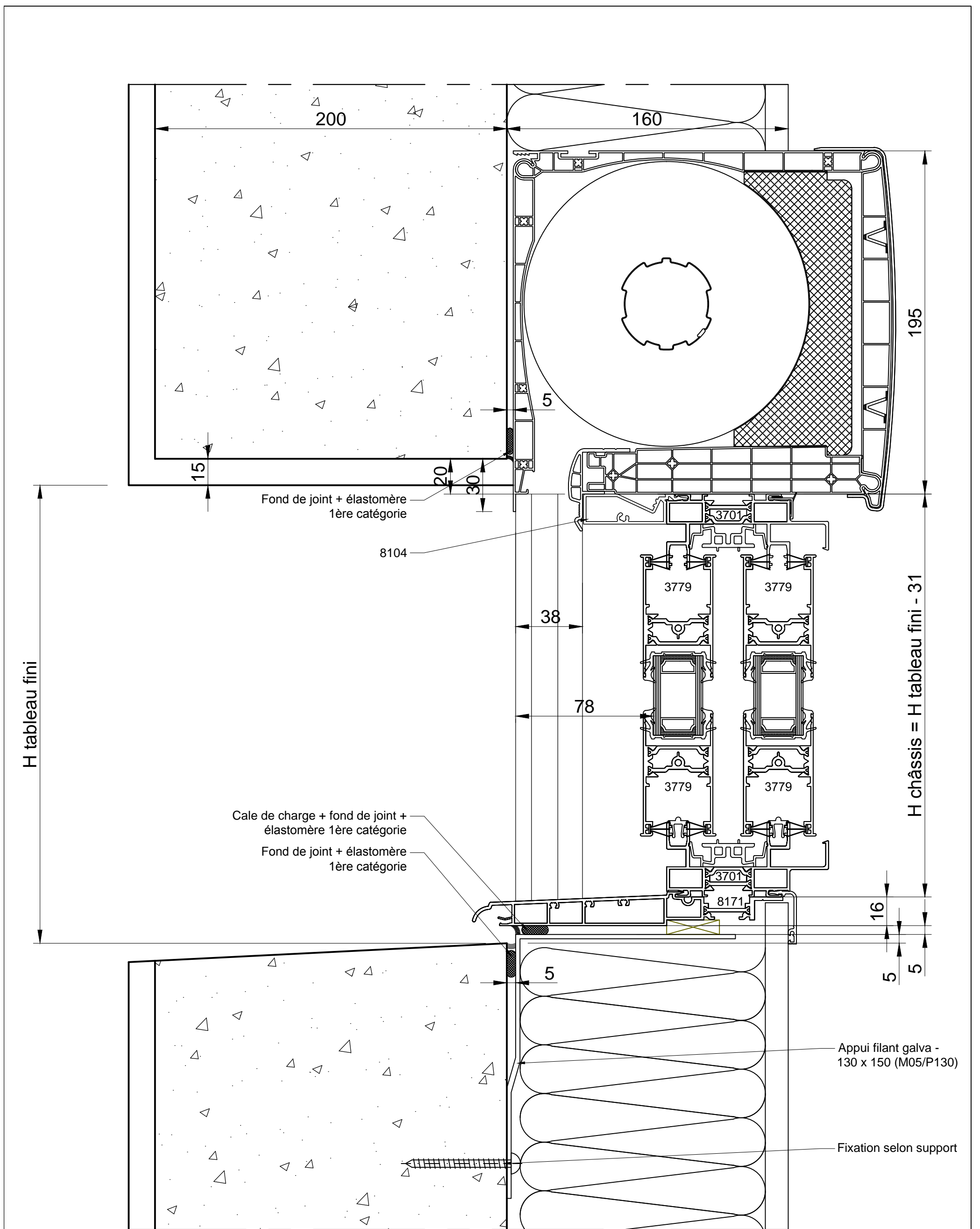

CATA TECH	Dessiné par E. TAVARES	Approuvé par N. BUERMANN	Coupe Verticale	Modifié le 11/02/2020	Date 28/11/2018	Echelle 1/2 - A3
 Fabricant de Fenêtres et Portes.			APPLIQUE RATTRAPAGE ISO 160			
			MISE EN OEUVRE	CO	Edition C	Feuille No. ALU 58

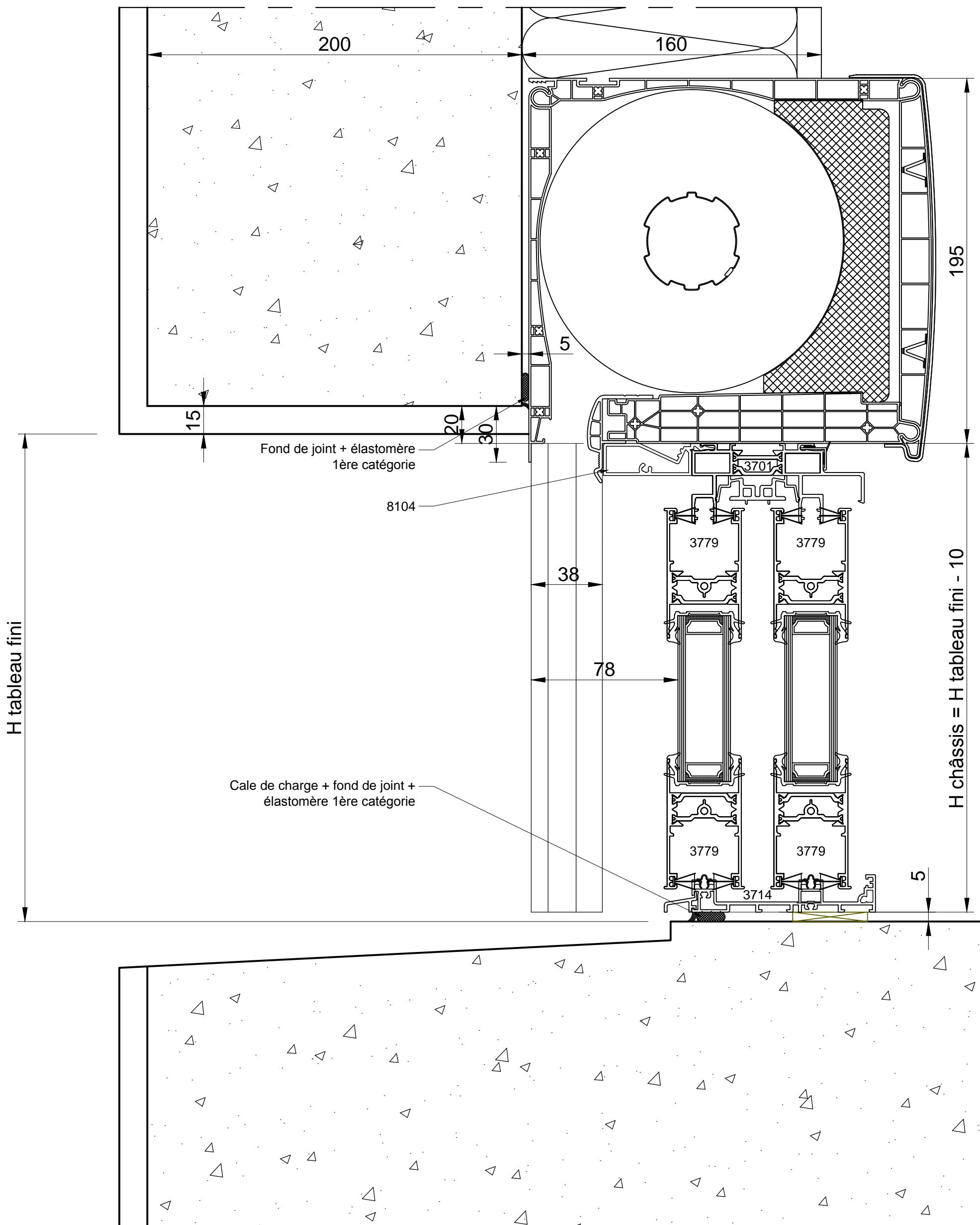

CATA TECH	Dessiné par E. TAVARES	Approuvé par N. BUERMANN	Coupe Verticale	Modifié le 11/02/2020	Date 28/11/2018	Echelle 1/2 - A3
 Fabricant de Fenêtres et Portes.			APPLIQUE RATTRAPAGE ISO 160			
			MISE EN OEUVRE	CO	Edition C	Feuille No. ALU 59

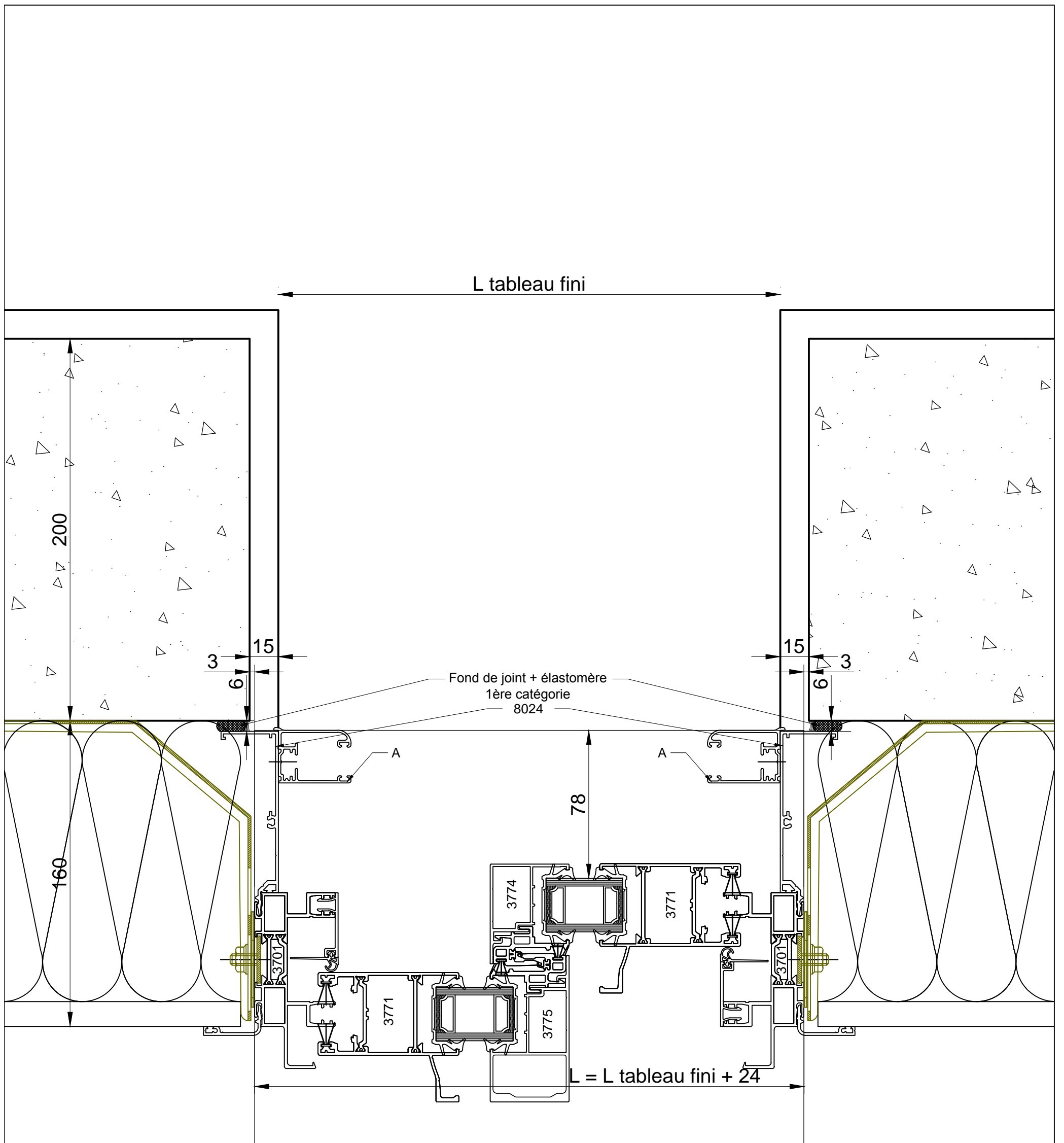

CATA TECH	Dessiné par E. TAVARES	Approuvé par N. BUERMANN	Coupe Horizontale	Modifié le 11/02/2020	Date 28/11/2018	Echelle 1/2 - A3
 Fabricant de Fenêtres et Portes.			APPLIQUE RATTRAPAGE ISO 160			
			MISE EN OEUVRE	CO	Edition C	Feuille No. ALU 60

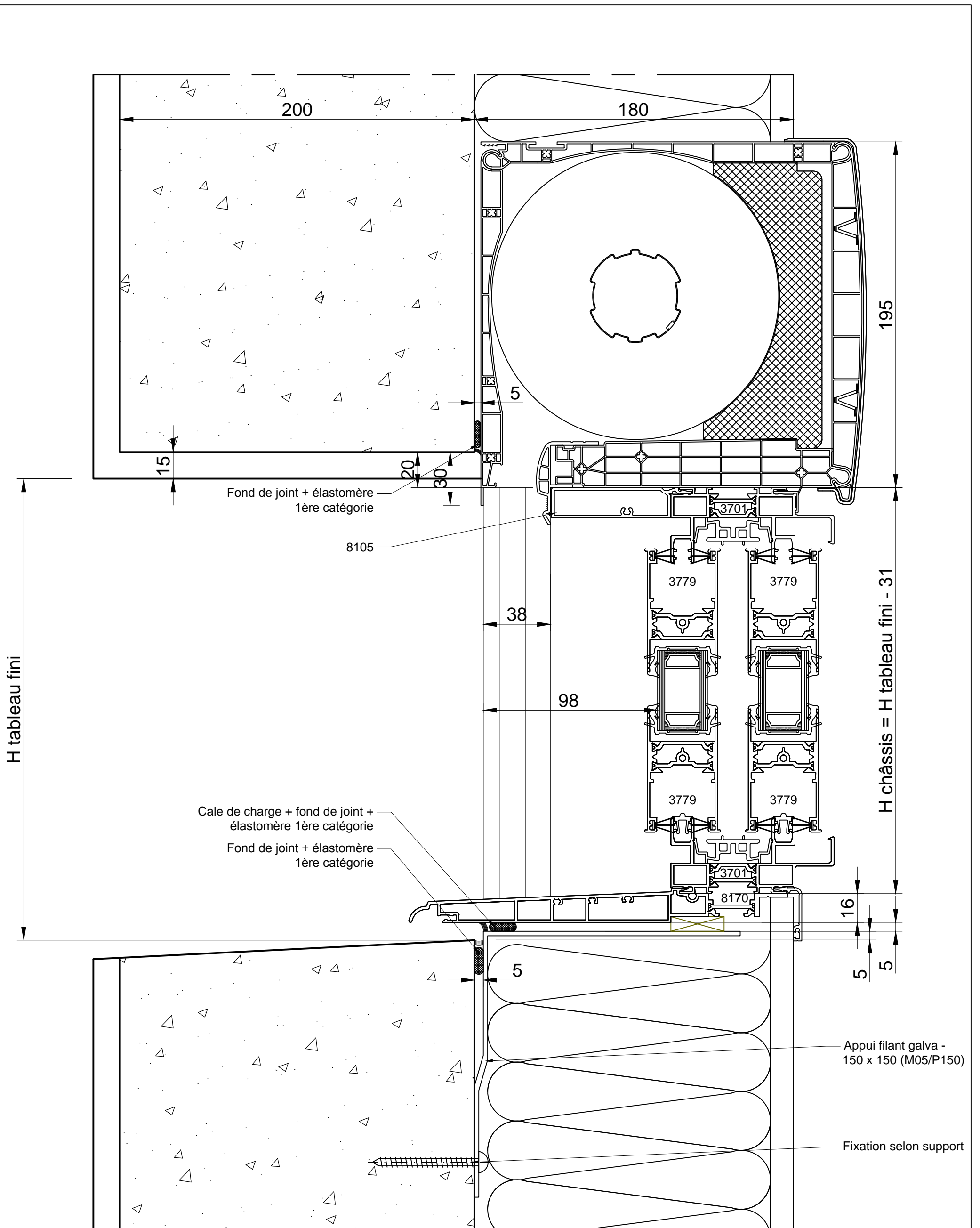

CATA TECH	Dessiné par E. TAVARES	Approuvé par N. BUERMANN	Coupe Verticale	Modifié le 11/02/2020	Date 28/11/2018	Echelle 1/2 - A3
 Fabricant de Fenêtres et Portes.			APPLIQUE RATTRAPAGE ISO 180			
			MISE EN OEUVRE CO	Edition C	Feuille No. ALU 61	

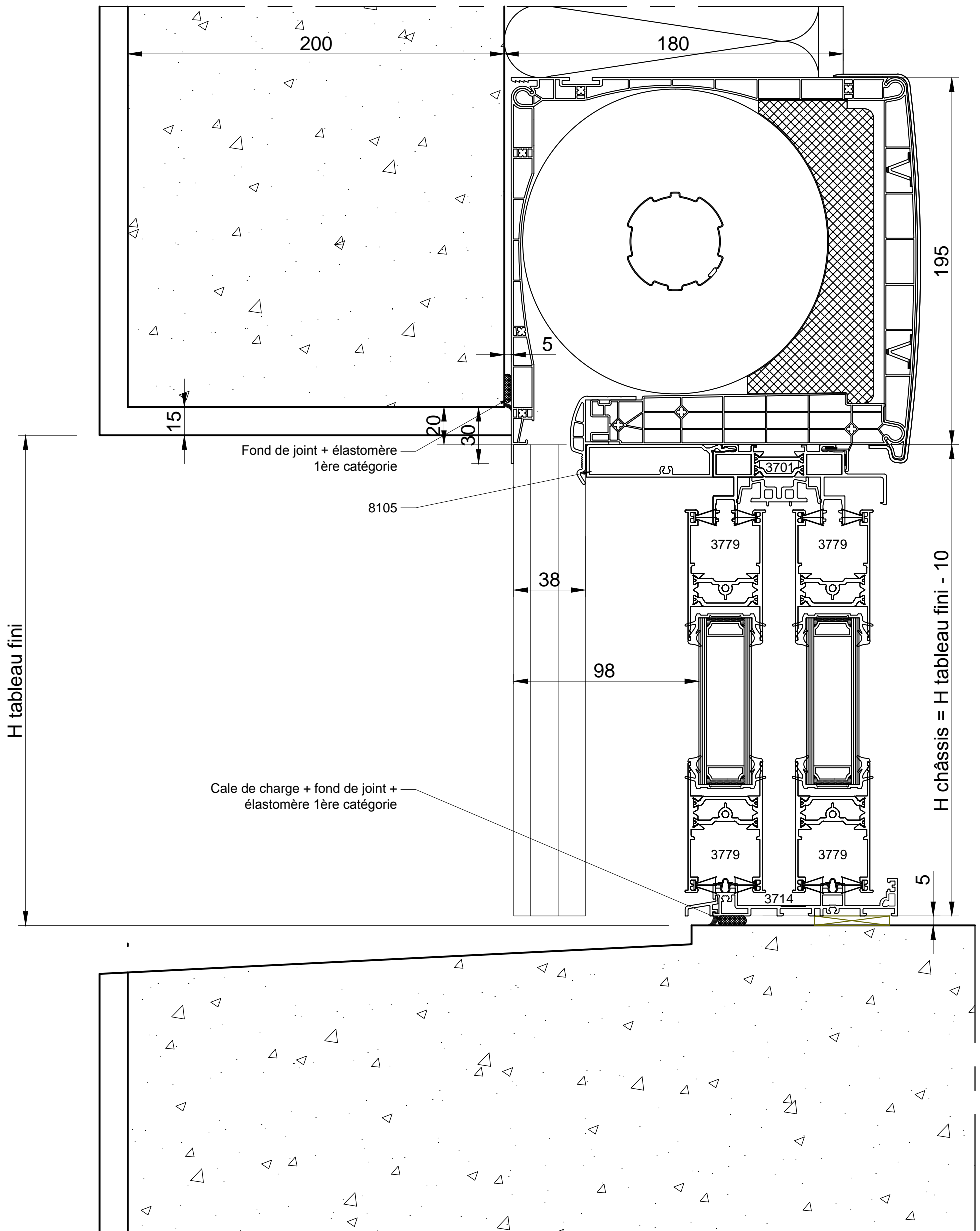

CATA TECH	Dessiné par E. TAVARES	Approuvé par N. BUERMANN	Coupe Verticale	Modifié le 11/02/2020	Date 28/11/2018	Echelle 1/2 - A3
 Fabricant de Fenêtres et Portes.			APPLIQUE RATRAPAGE ISO 180			
			MISE EN OEUVRE	CO	Edition C	Feuille No. ALU 62

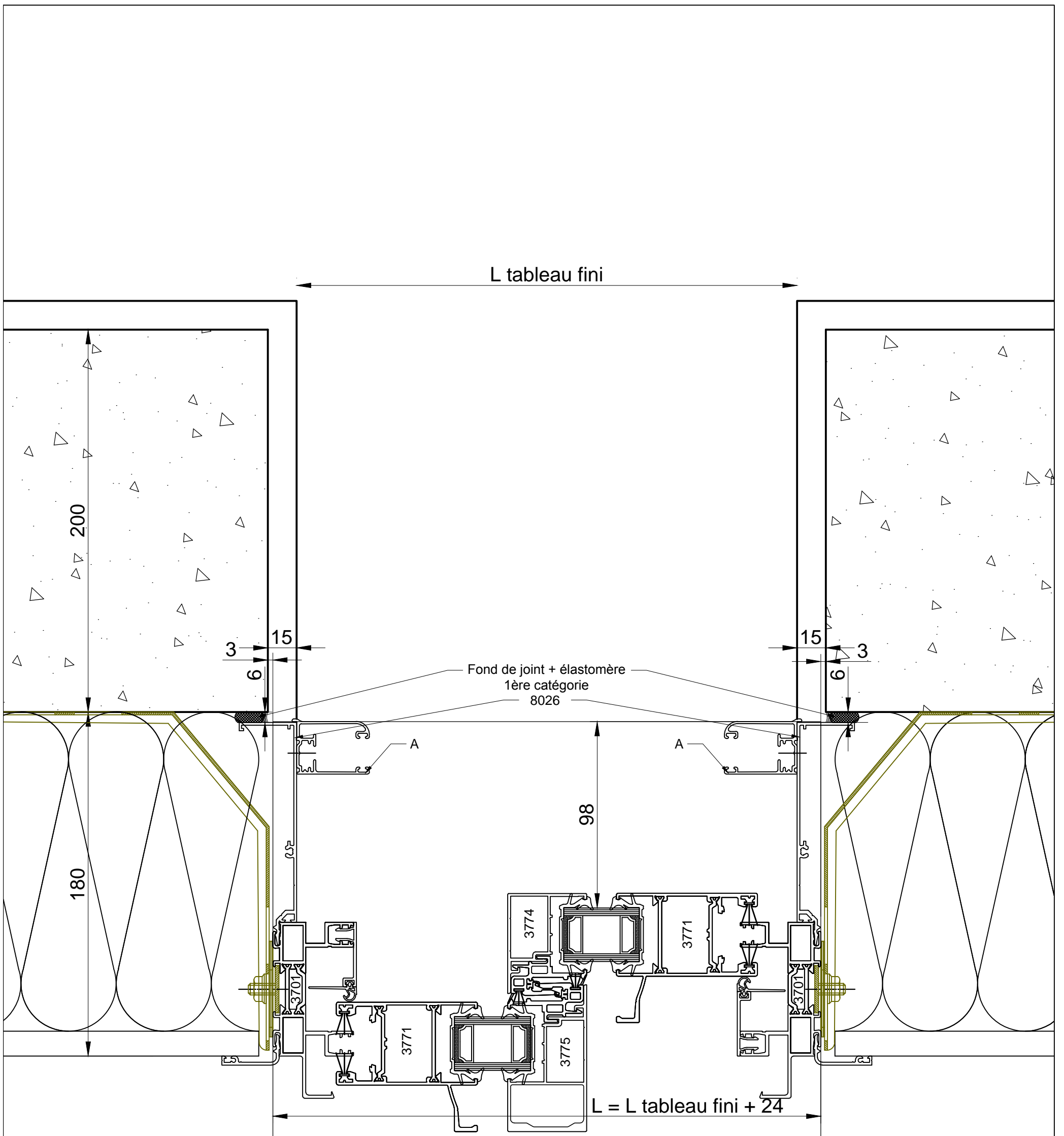

CATA TECH	Dessiné par E. TAVARES	Approuvé par N. BUERMANN	Coupe Horizontale	Modifié le 11/02/2020	Date 28/11/2018	Echelle 1/2 - A3
 Fabricant de Fenêtres et Portes.			APPLIQUE RATTRAPAGE ISO 180			
			MISE EN OEUVRE	CO	Edition C	Feuille No. ALU 63

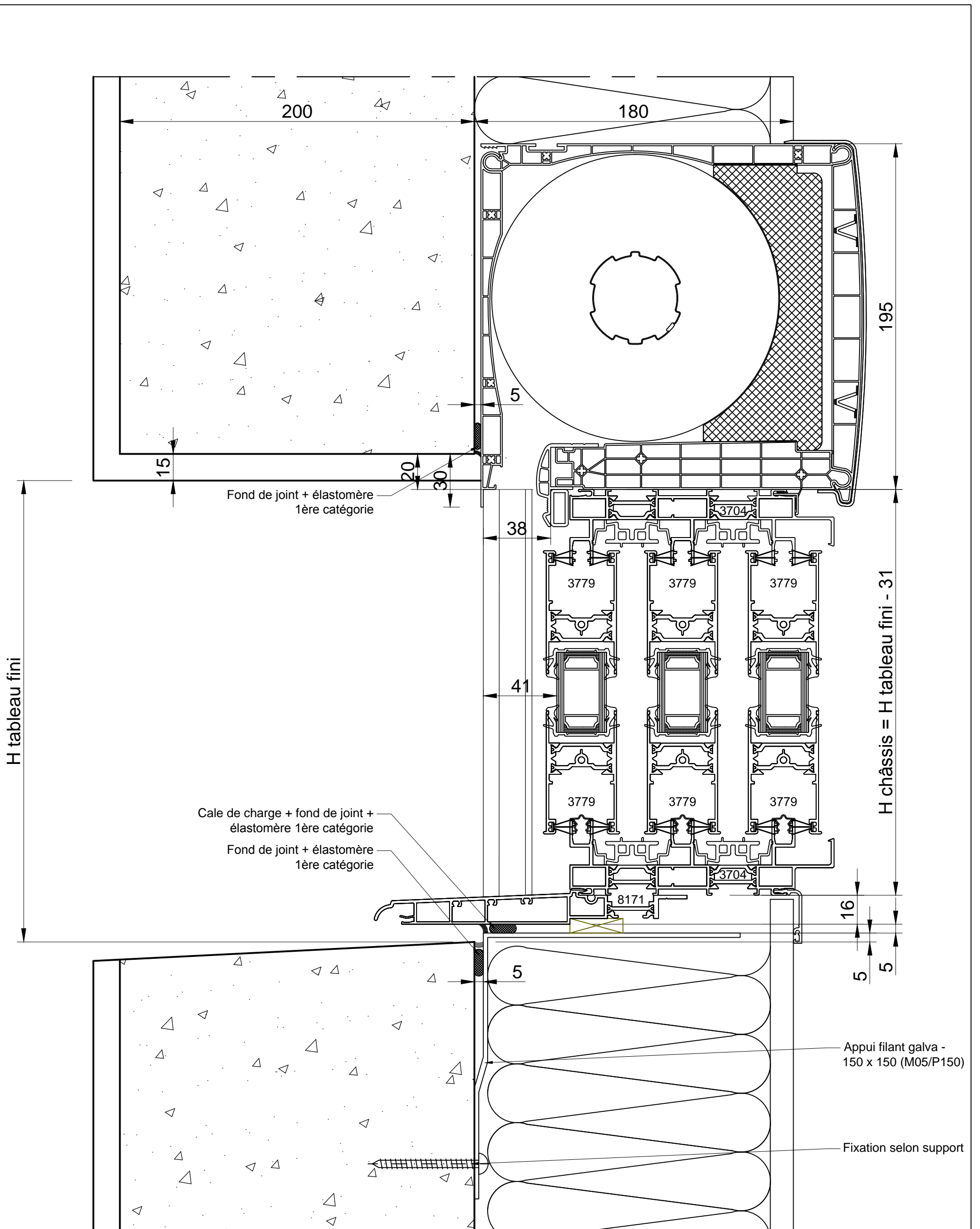

CATA TECH	Dessiné par E. TAVARES	Approuvé par N. BUERMANN	Coupe Verticale	Modifié le 11/02/2020	Date 28/11/2018	Echelle 1/2 - A3
 Fabricant de Fenêtres et Portes.			APPLIQUE RATTRAPAGE ISO 180			
			MISE EN OEUVRE	CO	Edition C	Feuille No. ALU 64

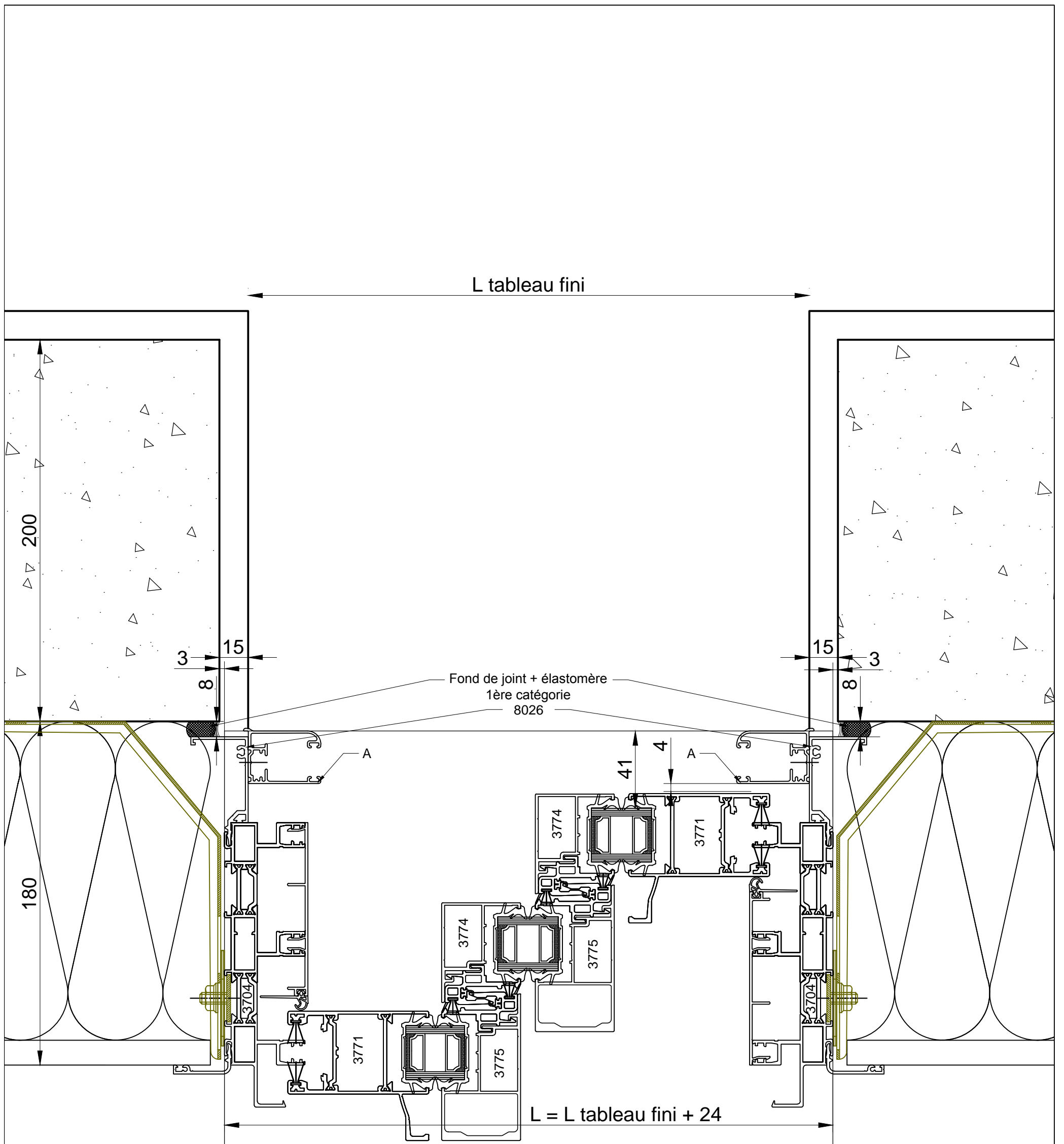

CATA TECH	Dessiné par E. TAVARES	Approuvé par N. BUERMANN	Coupe Horizontale	Modifié le 11/02/2020	Date 28/11/2018	Echelle 1/2 - A3
 Fabricant de Fenêtres et Portes.			APPLIQUE RATTRAPAGE ISO 180			
			MISE EN OEUVRE	CO	Edition C	Feuille No. ALU 65

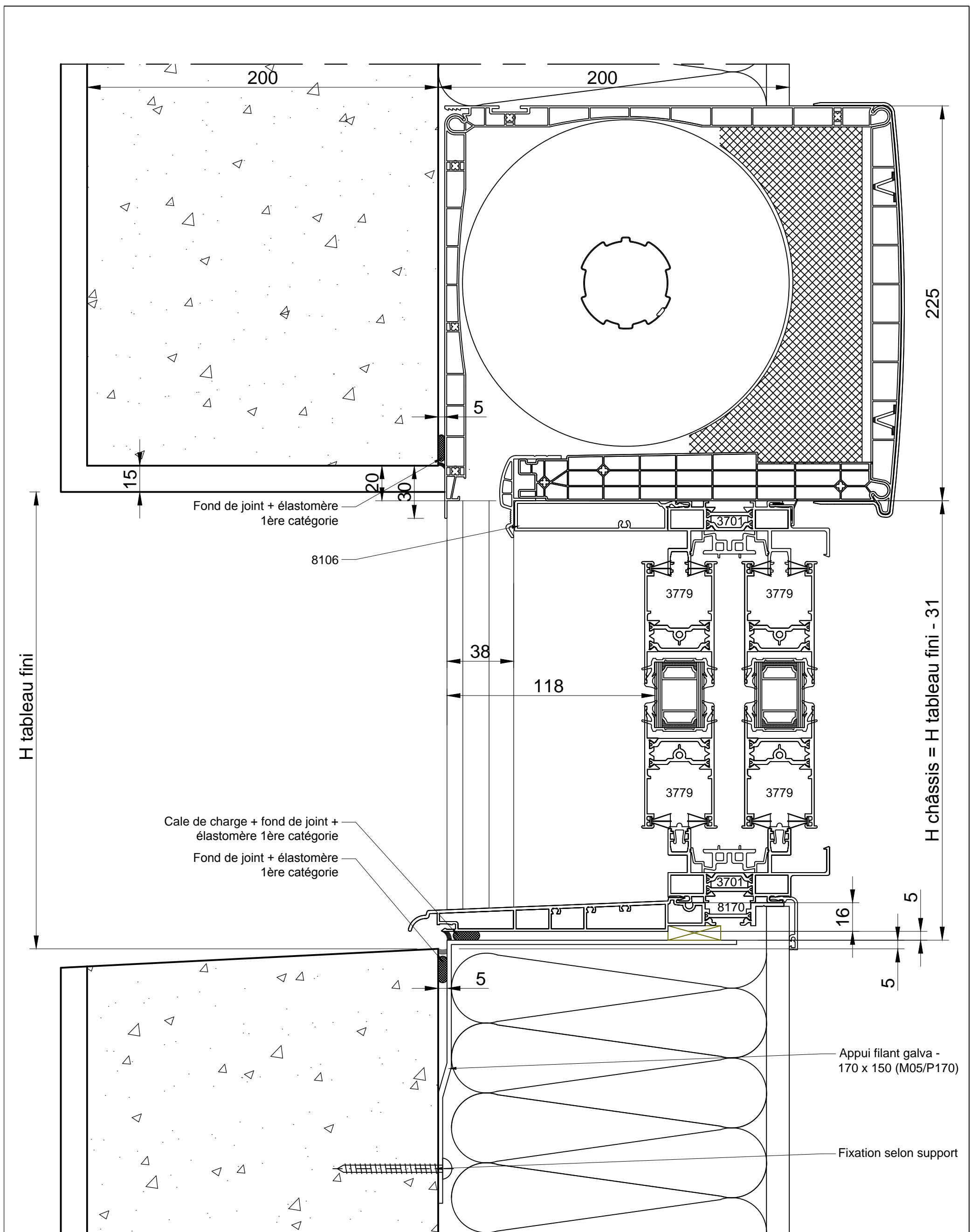

CATA TECH	Dessiné par E. TAVARES	Approuvé par N. BUERMANN	Coupe Verticale	Modifié le 11/02/2020	Date 28/11/2018	Echelle 1/2 - A3
 Fabricant de Fenêtres et Portes.			APPLIQUE RATTRAPAGE ISO 200			
			MISE EN OEUVRE	CO	Edition C	Feuille No. ALU 66

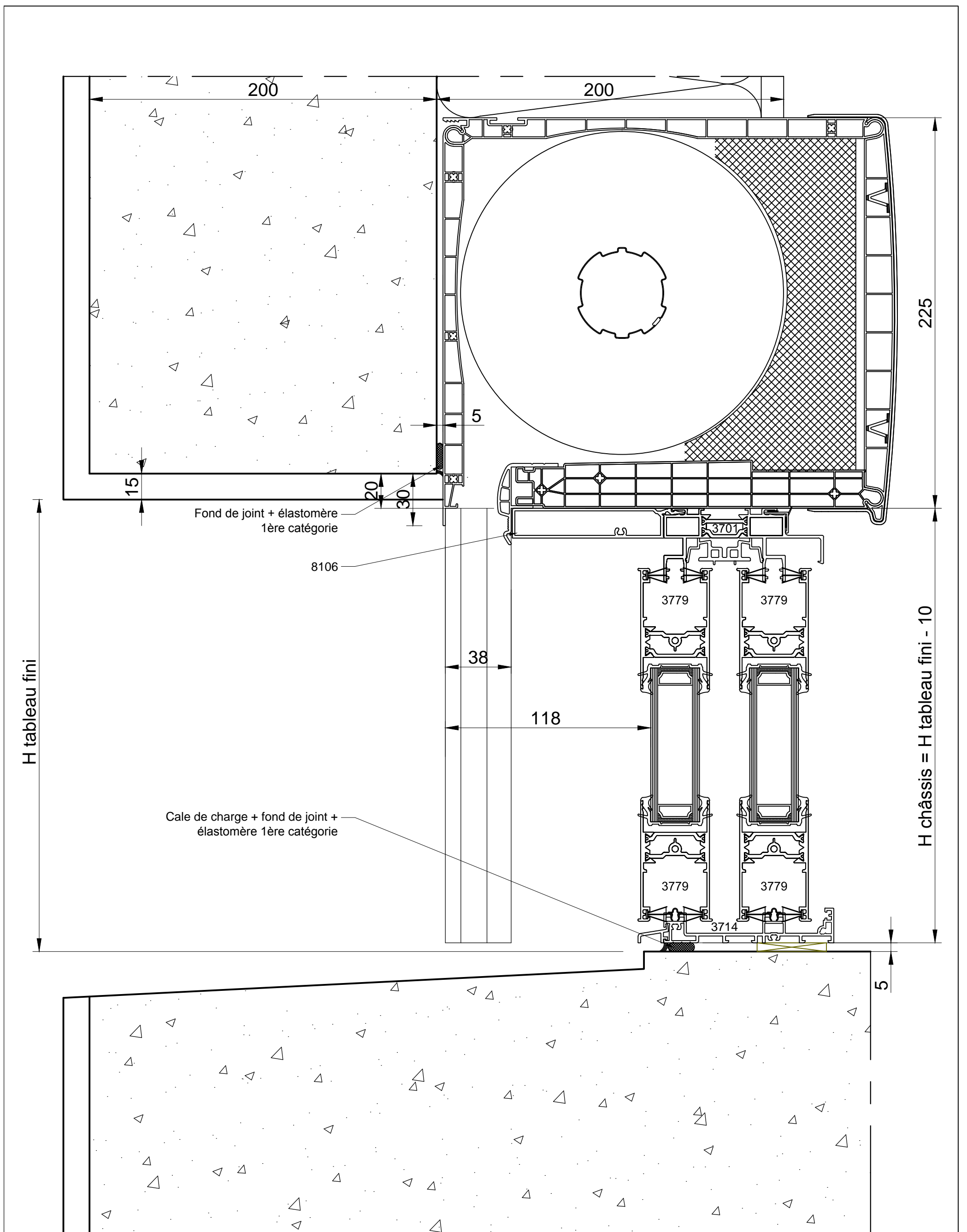

CATA TECH	Dessiné par E. TAVARES	Approuvé par N. BUERMANN	Coupe Verticale	Modifié le 11/02/2020	Date 28/11/2018	Echelle 1/2 - A3
 Fabricant de Fenêtres et Portes.			APPLIQUE RATTRAPAGE ISO 200			
			MISE EN OEUVRE	CO	Edition C	Feuille No. ALU 67

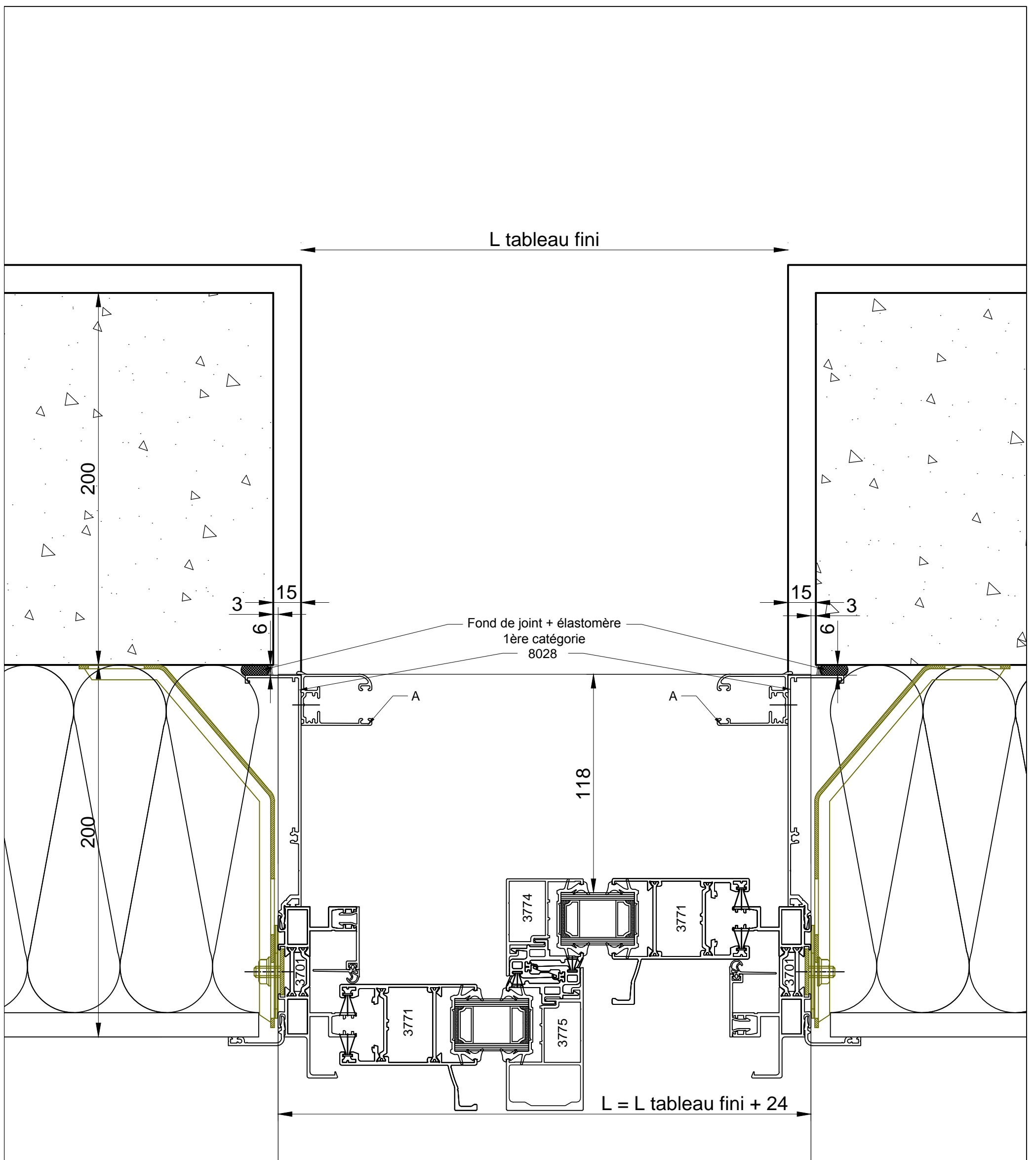

CATA TECH	Dessiné par E. TAVARES	Approuvé par N. BUERMANN	Coupe Horizontale	Modifié le 11/02/2020	Date 28/11/2018	Echelle 1/2 - A3
 Fabricant de Fenêtres et Portes.			APPLIQUE RATRAPAGE ISO 200			
			MISE EN OEUVRE	CO	Edition C	Feuille No. ALU 68

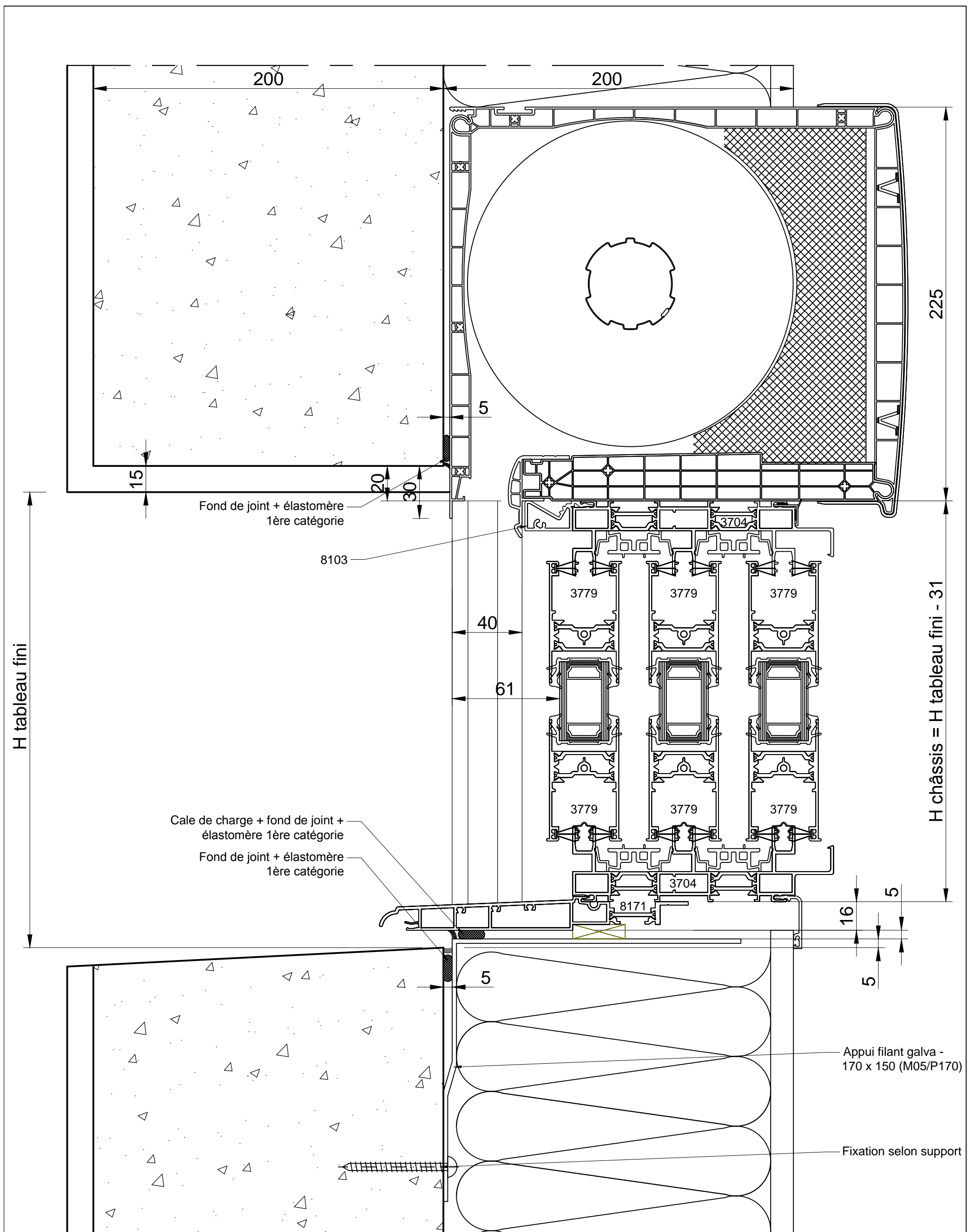

CATA TECH	Dessiné par E. TAVARES	Approuvé par N. BUERMANN	Coupe Verticale	Modifié le 11/02/2020	Date 28/11/2018	Echelle 1/2 - A3
 Fabricant de Fenêtres et Portes.			APPLIQUE RATTRAPAGE ISO 200			
			MISE EN OEUVRE CO	Edition C	Feuille No. ALU 69	

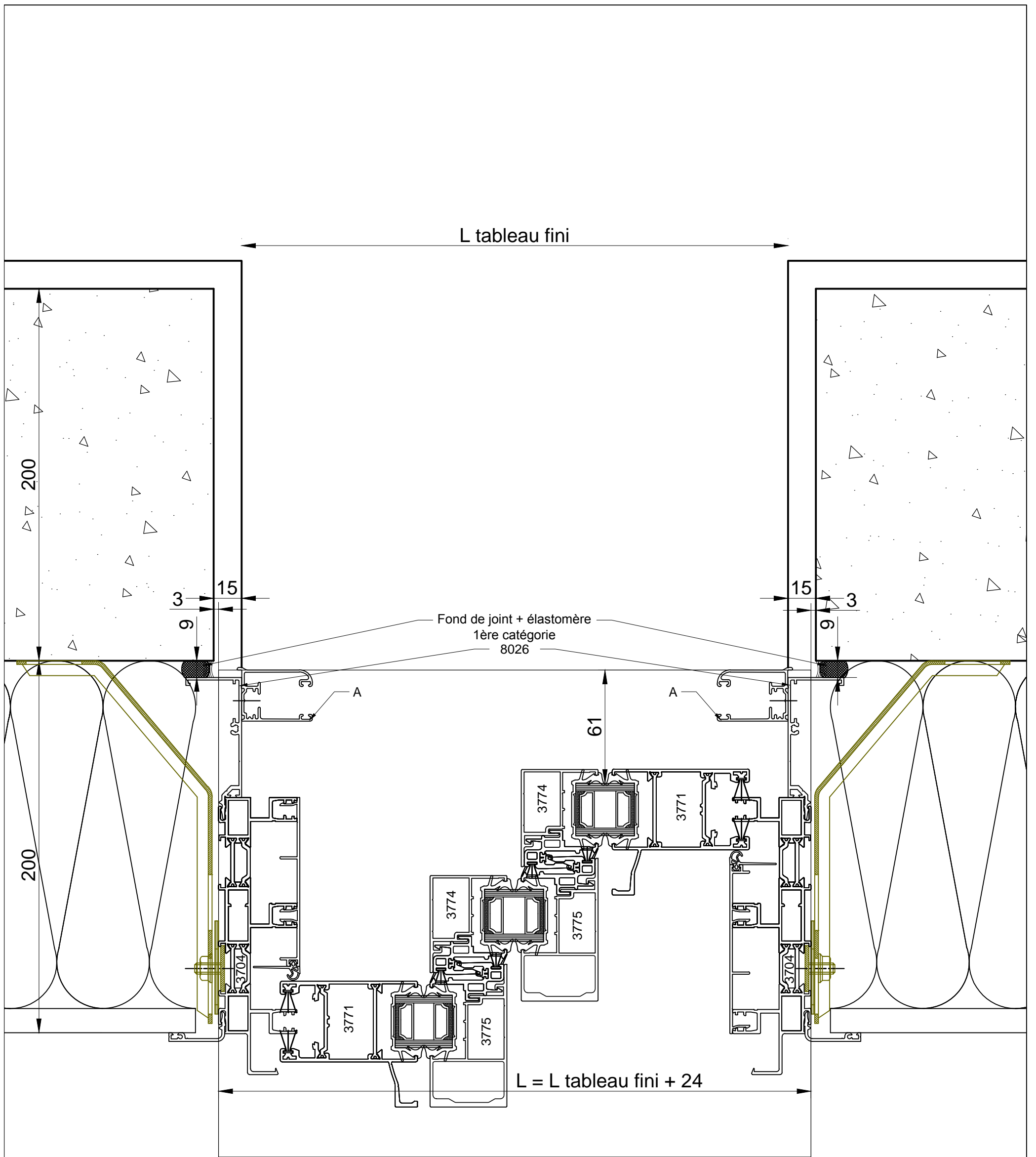

CATA TECH	Dessiné par E. TAVARES	Approuvé par N. BUERMANN	Coupe Horizontale	Modifié le 11/02/2020	Date 28/11/2018	Echelle 1/2 - A3
 Fabricant de Fenêtres et Portes.			APPLIQUE RATTRAPAGE ISO 200			
			MISE EN OEUVRE	CO	Edition C	Feuille No. ALU 70

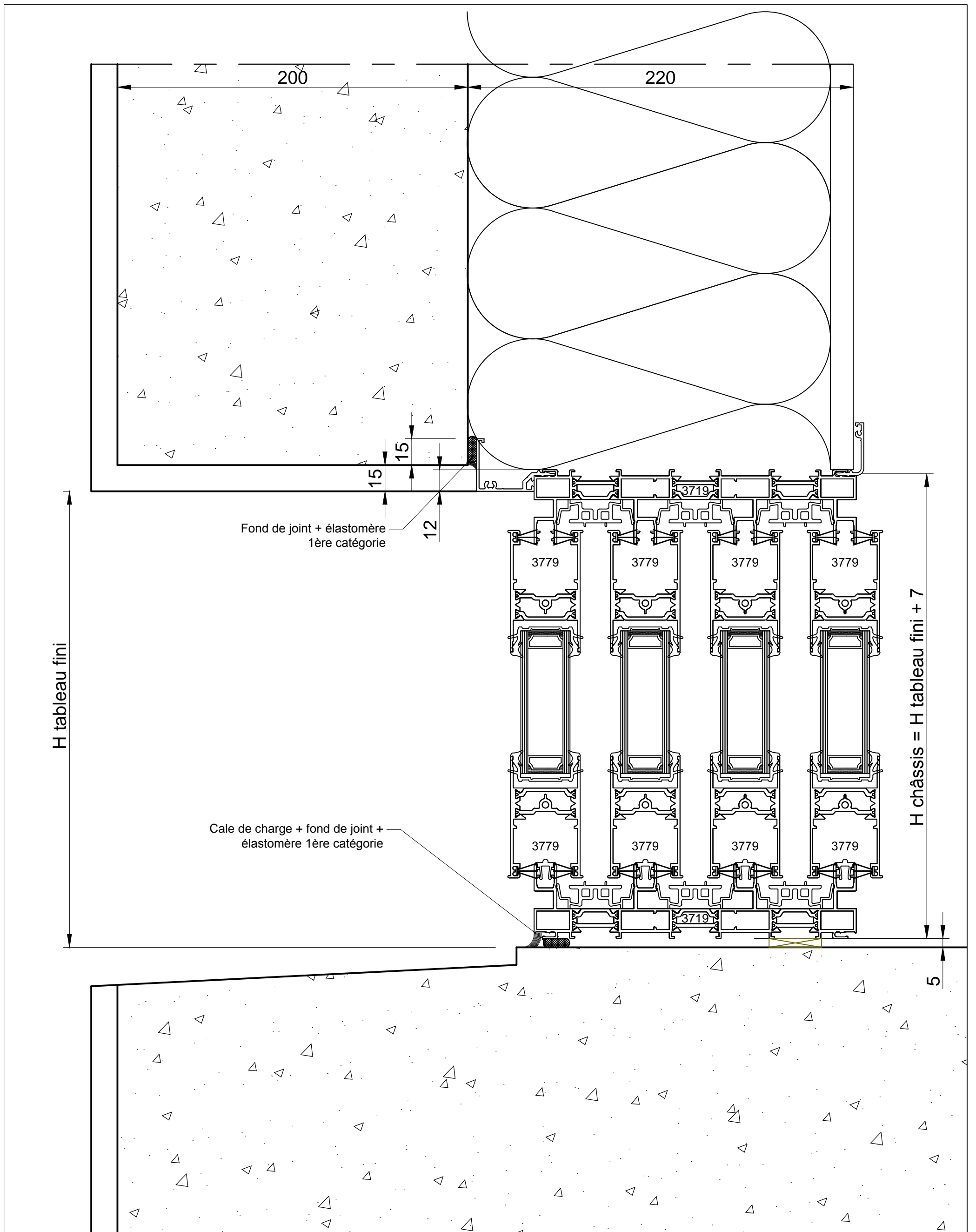

CATA TECH	Dessiné par E. TAVARES	Approuvé par N. BUERMANN	Coupe Verticale	Modifié le 11/02/2020	Date 28/11/2018	Echelle 1/2 - A3
 <p>hilzinger Fabricant de Fenêtres et Portes.</p>			APPLIQUE ISO 220 4 VTX 4 RAILS			
			MISE EN OEUVRE	CO	Edition C	Feuille No. ALU 71

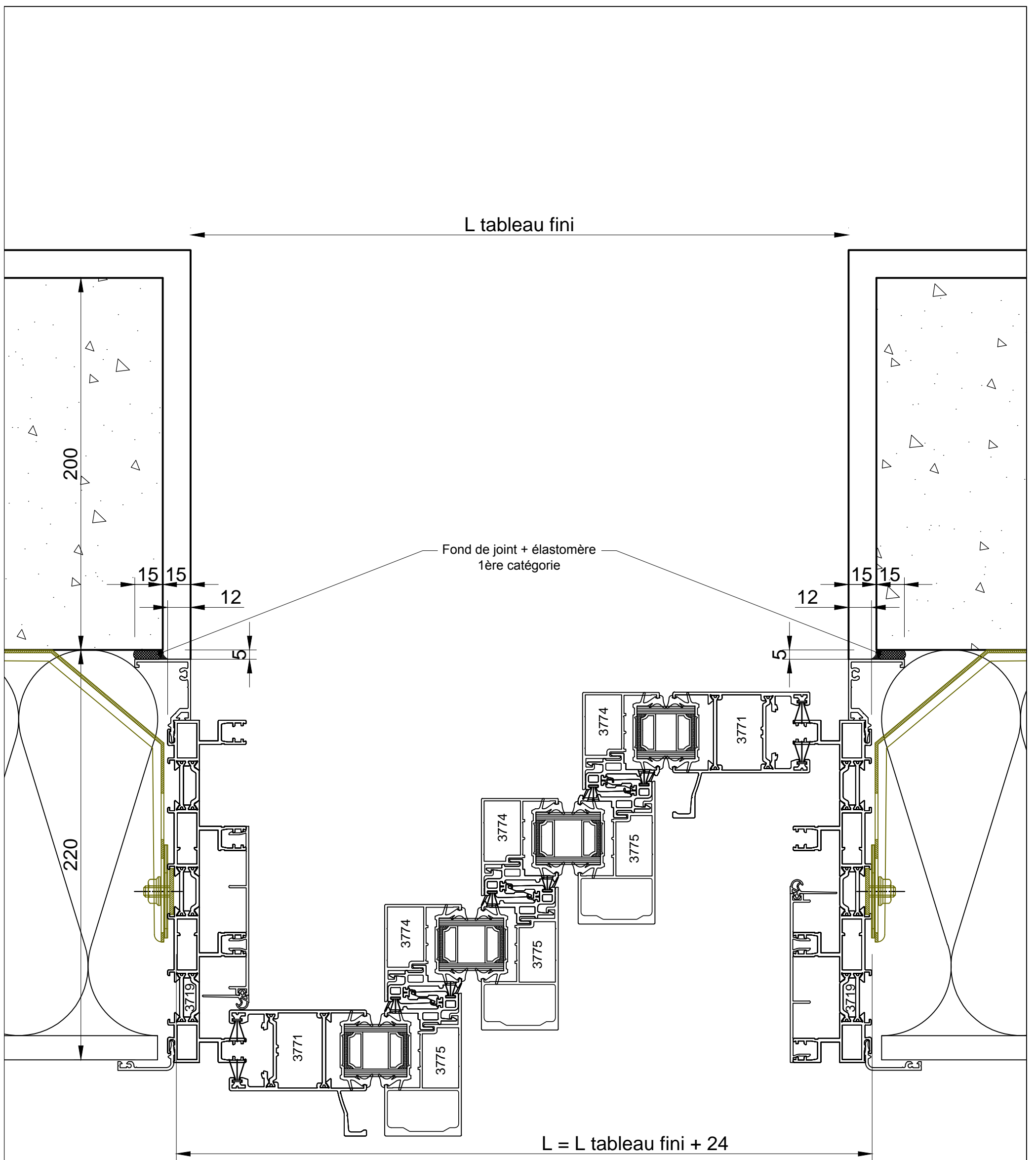

CATA TECH	Dessiné par E. TAVARES	Approuvé par N. BUERMANN	Coupe Horizontale	Modifié le 11/02/2020	Date 28/11/2018	Echelle 1/2 - A3
 Fabricant de Fenêtres et Portes.			APPLIQUE ISO 220 4 VTX 4 RAILS			
			MISE EN OEUVRE	CO	Edition C	Feuille No. ALU 72

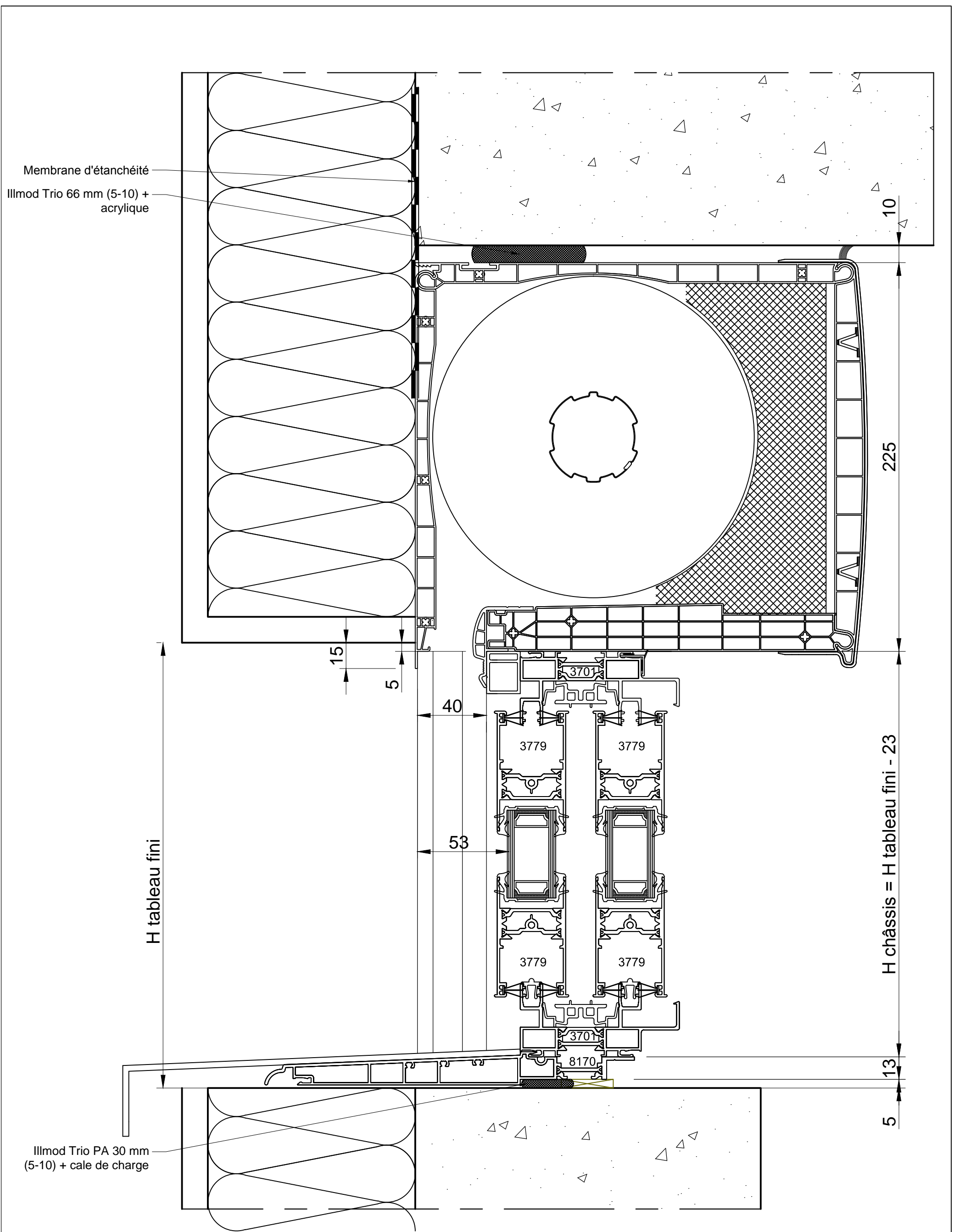

CATA TECH	Dessiné par E. TAVARES	Approuvé par N. BUERMANN	Coupe Horizontale	Modifié le 11/02/2020	Date 28/11/2018	Echelle 1/2 - A3
 Fabricant de Fenêtres et Portes.			POSE EN TUNNEL			
			MISE EN OEUVRE	Edition C	Feuille No. ALU 73	

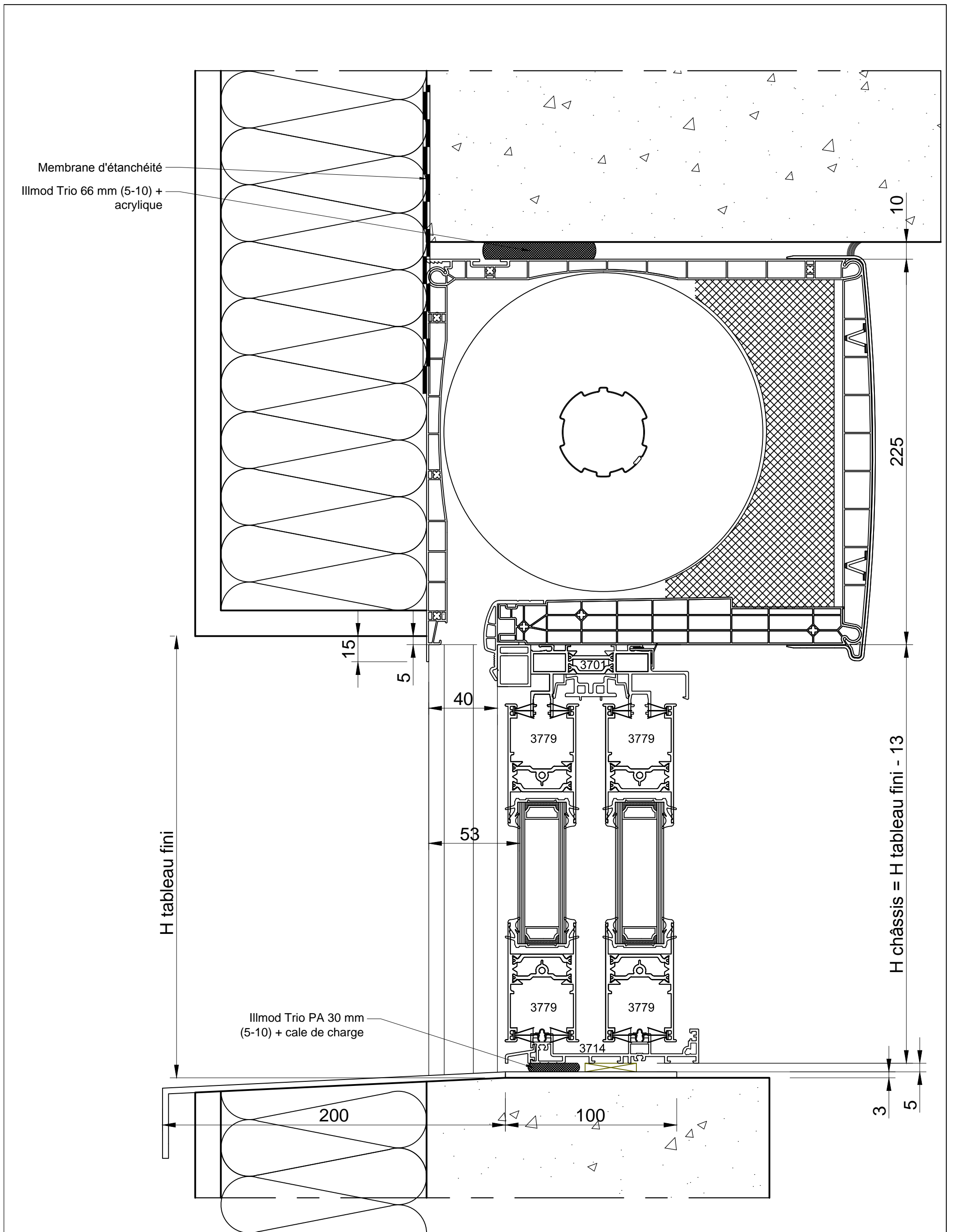

CATA TECH	Dessiné par E. TAVARES	Approuvé par N. BUERMANN	Coupe Horizontale	Modifié le 11/02/2020	Date 28/11/2018	Echelle 1/2 - A3
 Fabricant de Fenêtres et Portes.			POSE EN TUNNEL			
			MISE EN OEUVRE	Edition C	Feuille No. ALU 74	

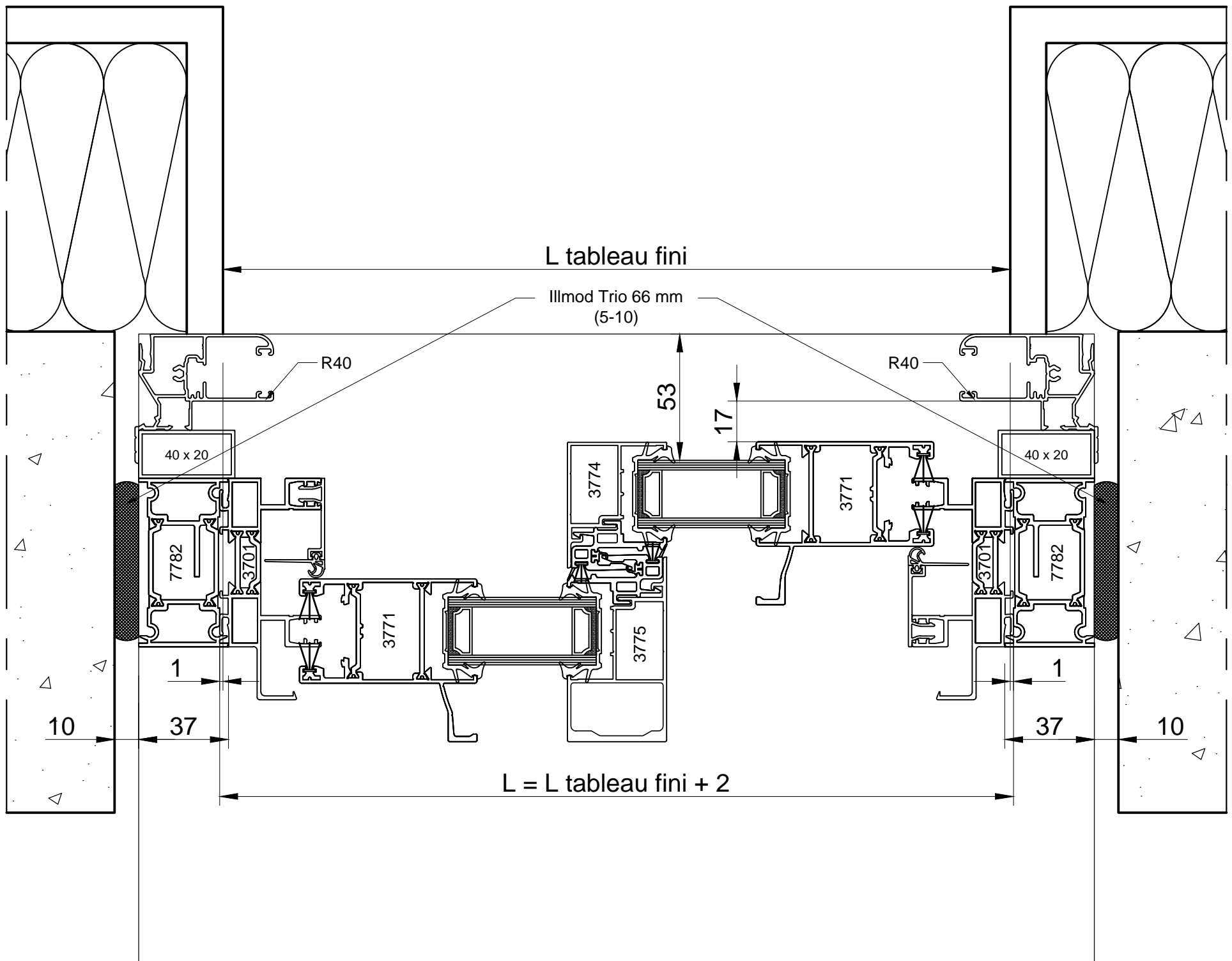

CATA TECH	Dessiné par E. TAVARES	Approuvé par N. BUERMANN	Coupe Horizontale	Modifié le 11/02/2020	Date 28/11/2018	Echelle 1/2 - A3
 Fabricant de Fenêtres et Portes.			POSE EN TUNNEL			
			MISE EN OEUVRE	Edition C	Feuille No. ALU 75	

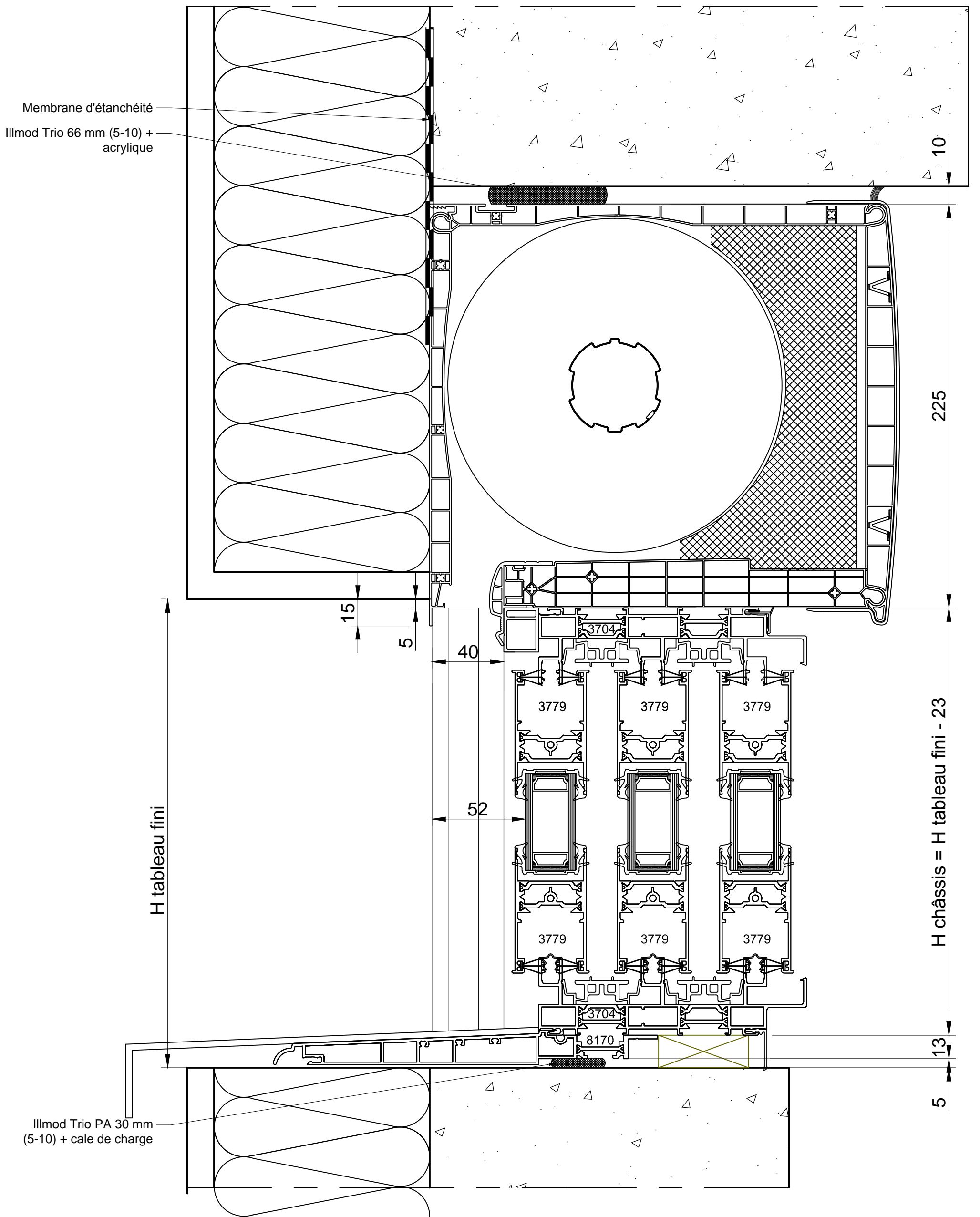

CATA TECH

Dessiné par
E. TAVARES

Approuvé par
N. BUERMANN

Coupe
Verticale

Modifié le
11/02/2020

Date
28/11/2018

Echelle
1/2 - A3

hilzinger
Fabricant de Fenêtres et Portes.

POSE EN TUNNEL

MISE EN OEUVRE

Edition
C

Feuille No.
ALU 76

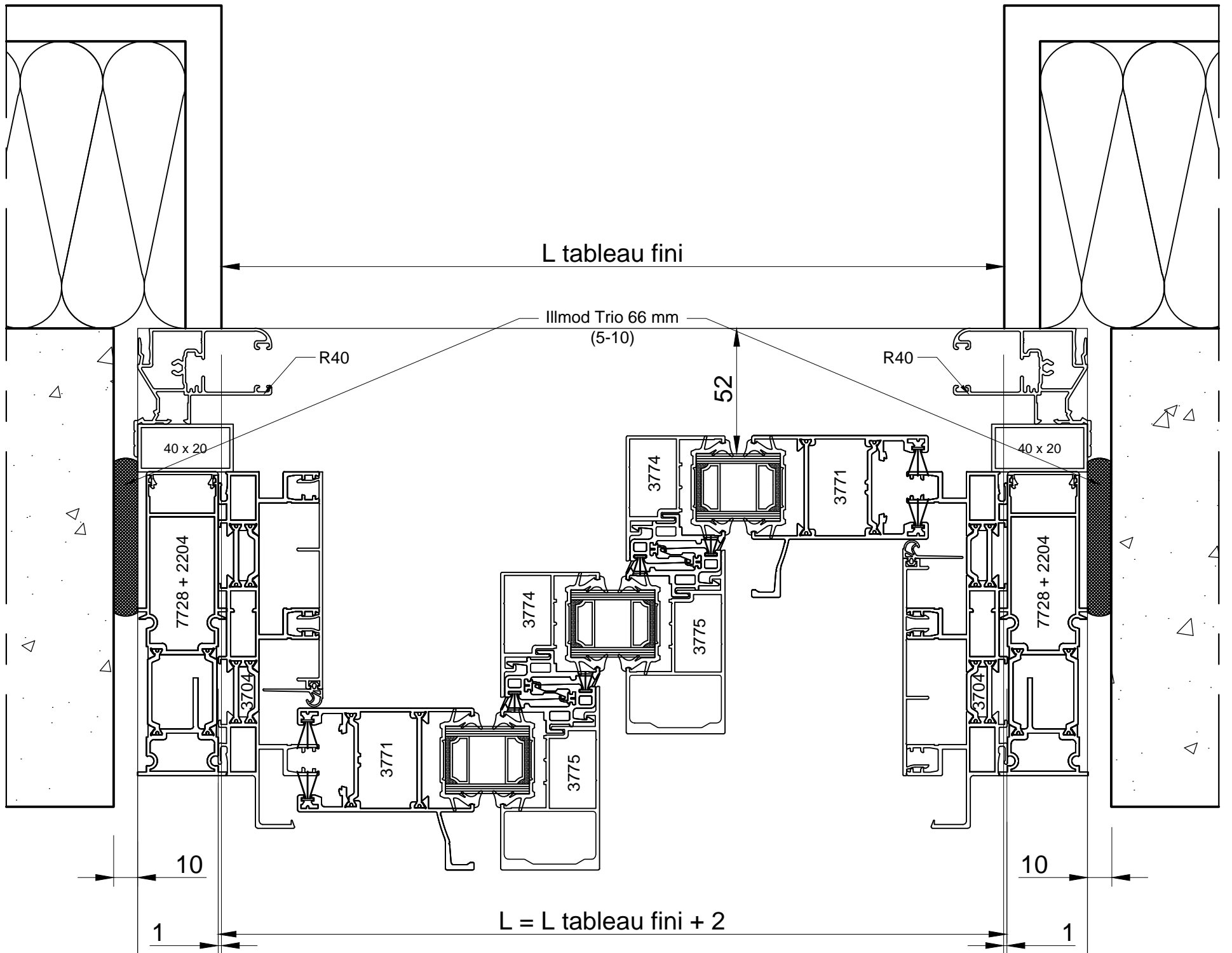

CATA TECH	Dessiné par E. TAVARES	Approuvé par N. BUERMANN	Coupe Horizontale	Modifié le 11/02/2020	Date 28/11/2018	Echelle 1/2 - A3
 Fabricant de Fenêtres et Portes.			POSE EN TUNNEL			
			MISE EN OEUVRE	Edition C	Feuille No. ALU 77	

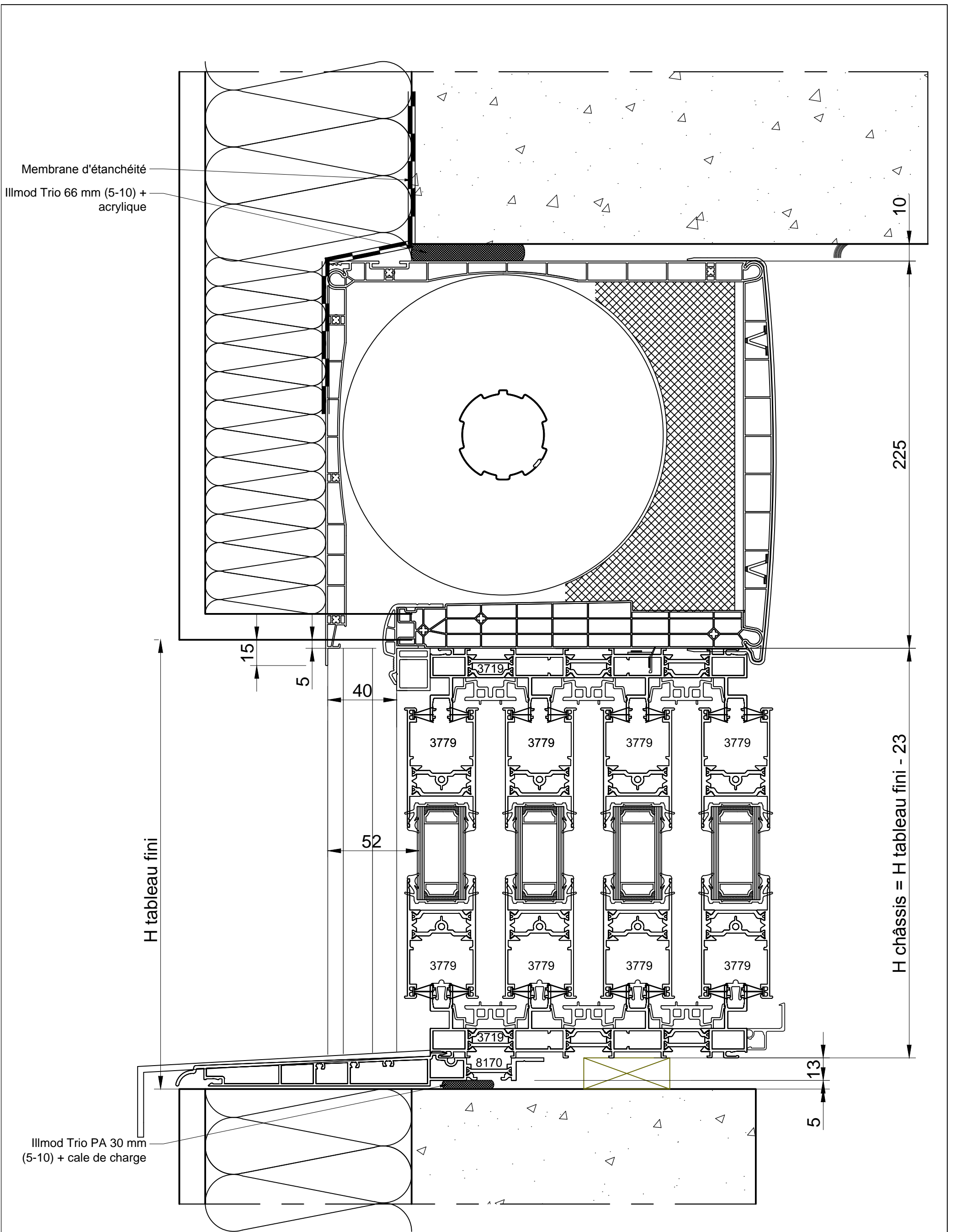

CATA TECH	Dessiné par E. TAVARES	Approuvé par N. BUERMANN	Coupe Verticale	Modifié le 11/02/2020	Date 28/11/2018	Echelle 1/2 - A3
-----------	---------------------------	-----------------------------	--------------------	--------------------------	--------------------	---------------------





POSE EN TUNNEL

MISE EN OEUVRE

Edition
C

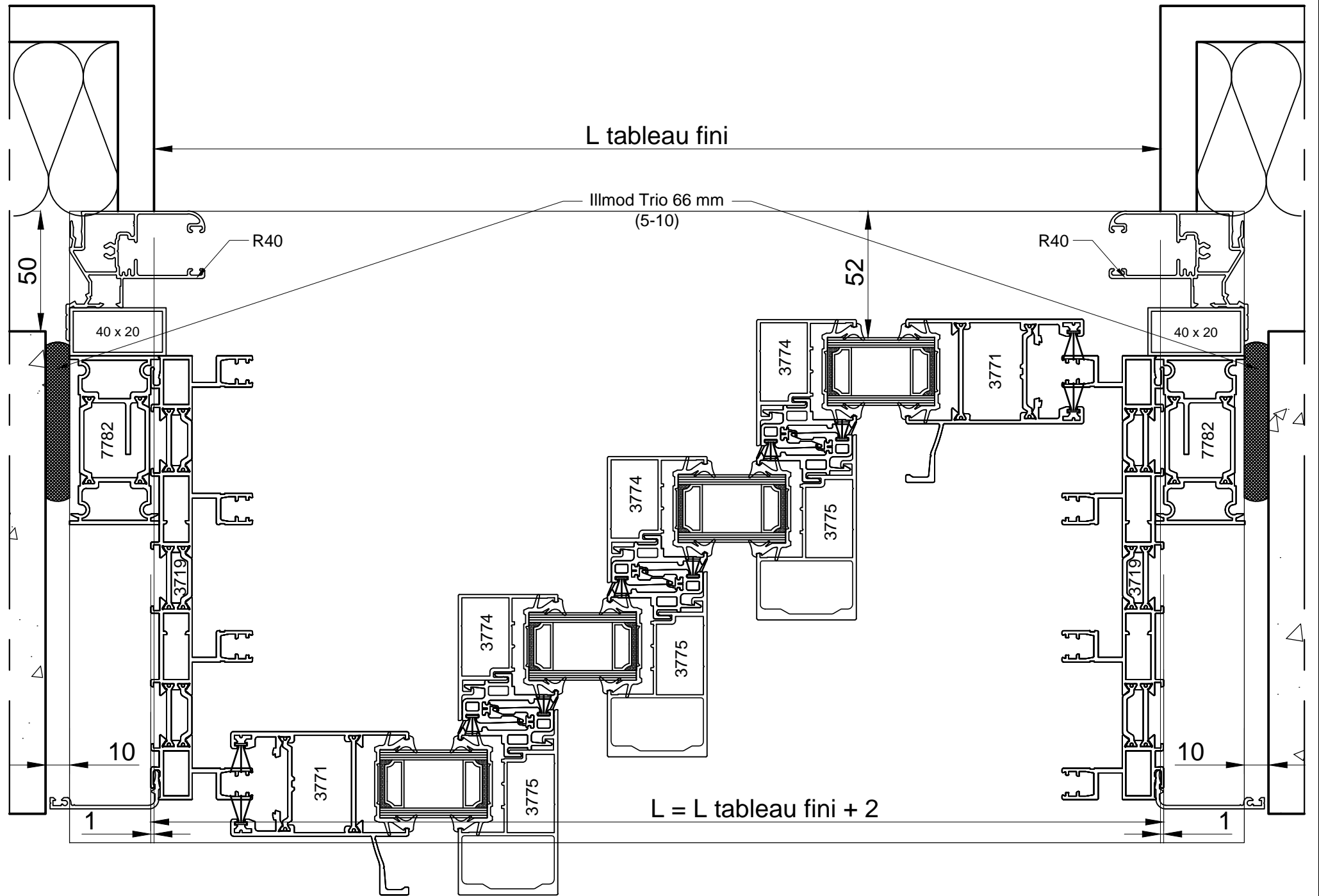
Feuille No.
ALU 78



CATA TECH	Dessiné par E. TAVARES	Approuvé par N. BUERMANN	Coupe Horizontale	Modifié le 11/02/2020	Date 28/11/2018	Echelle 1/2 - A3
 Fabricant de Fenêtres et Portes.			POSE EN TUNNEL			
			MISE EN OEUVRE	Edition C	Feuille No. ALU 79	

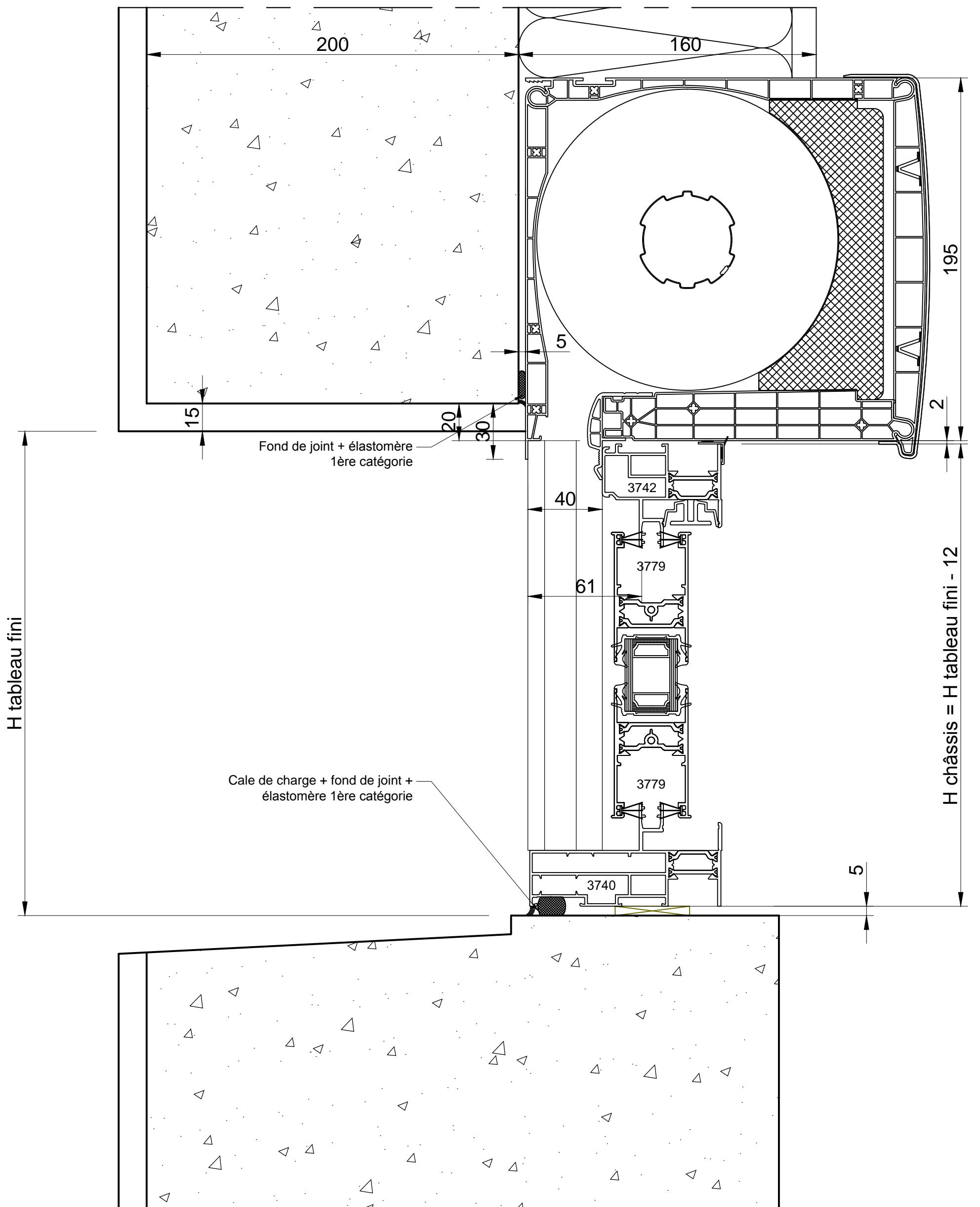

CATA TECH	Dessiné par E. TAVARES	Approuvé par N. BUERMANN	Coupe Verticale	Modifié le 11/02/2020	Date 28/11/2018	Echelle 1/2 - A3
 Fabricant de Fenêtres et Portes.			COULISSANT A GALANDAGE			
			MISE EN OEUVRE			Edition C

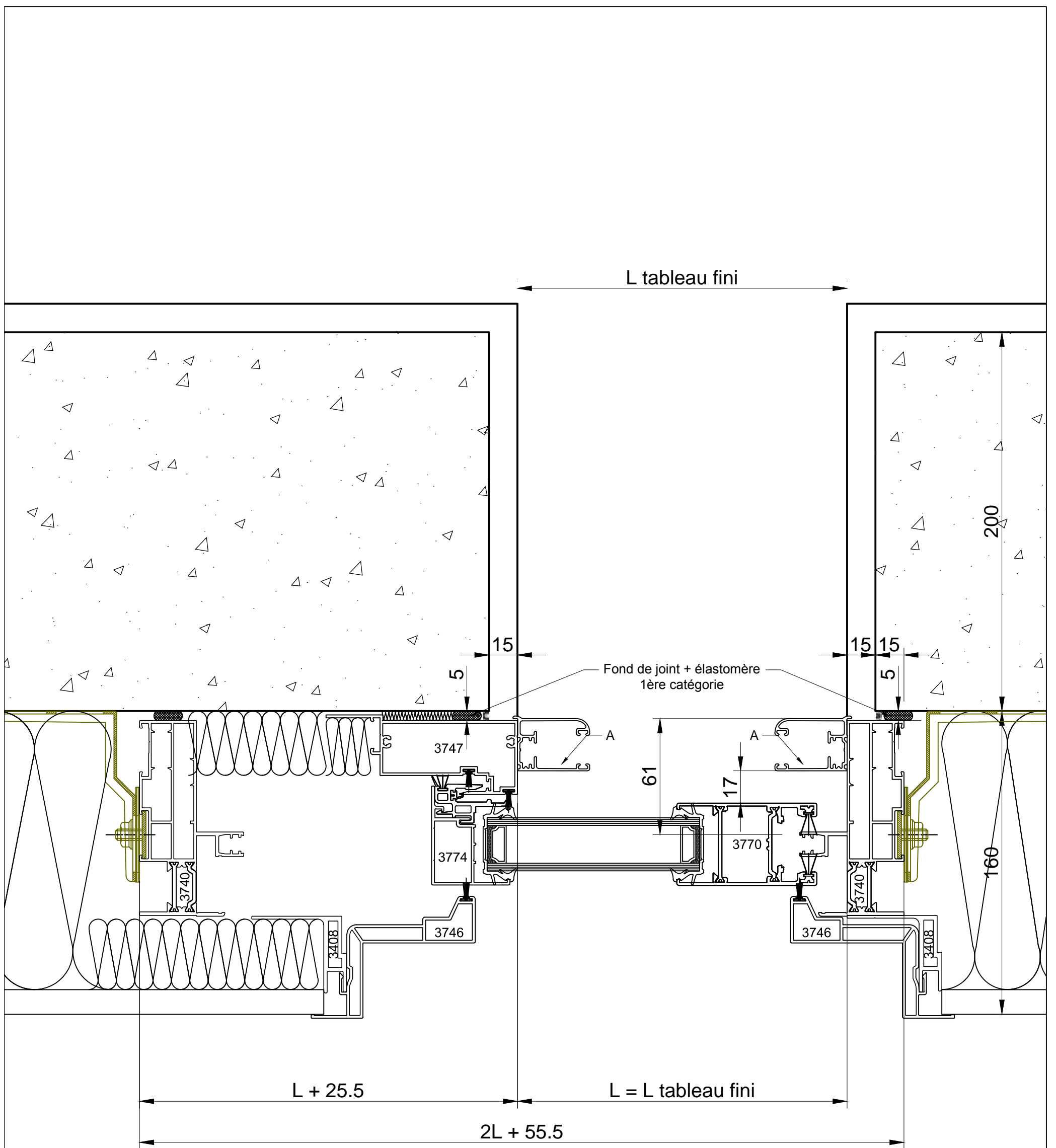

CATA TECH	Dessiné par E. TAVARES	Approuvé par N. BUERMANN	Coupe Horizontale	Modifié le 11/02/2020	Date 28/11/2018	Echelle 1/2 - A3
 Fabricant de Fenêtres et Portes.			COULISSANT A GALANDAGE			
			MISE EN OEUVRE			Edition C

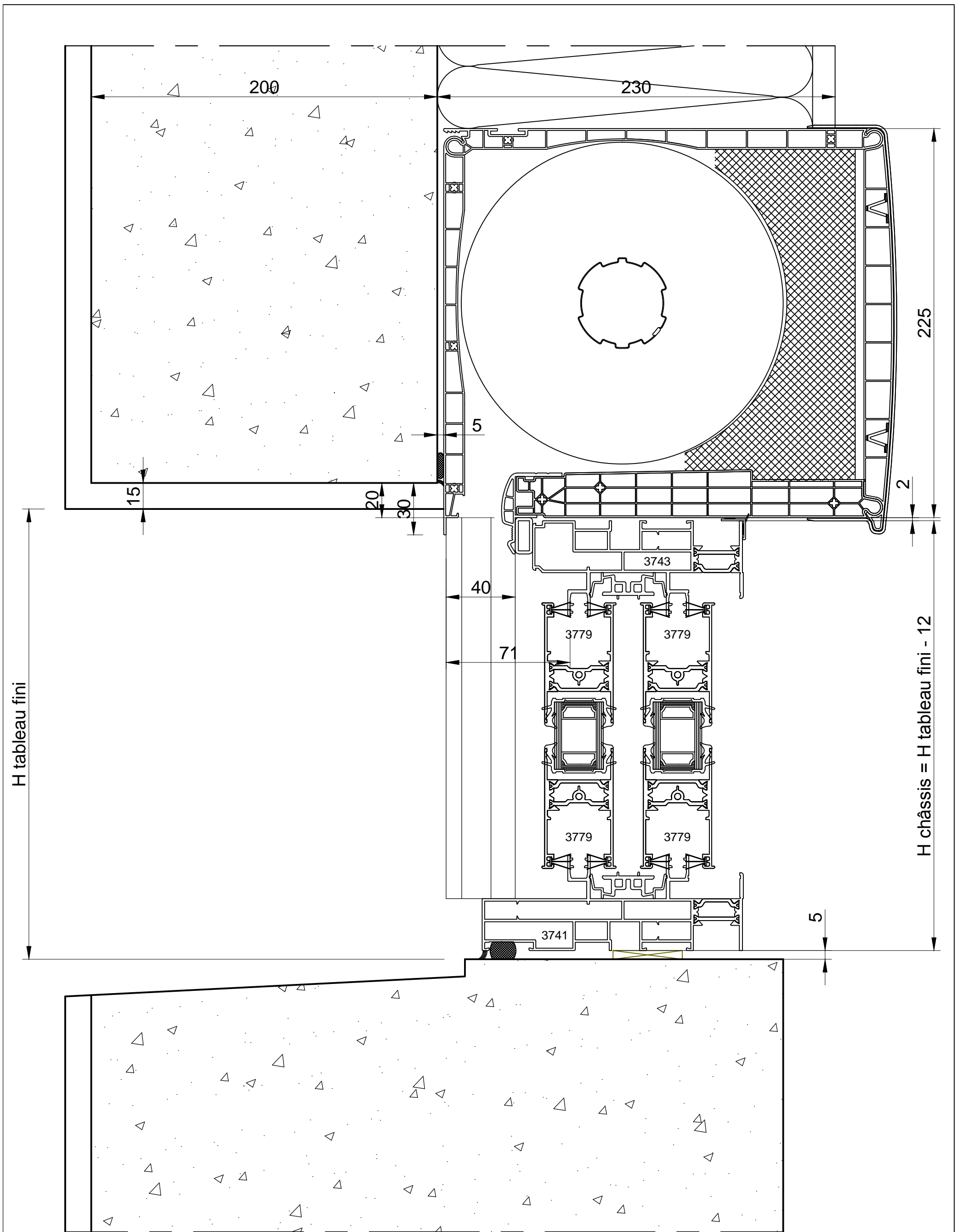

CATA TECH	Dessiné par E. TAVARES	Approuvé par N. BUERMANN	Coupe Verticale	Modifié le 11/02/2020	Date 28/11/2018	Echelle 1/2 - A3
 Fabricant de Fenêtres et Portes.			COULISSANT A GALANDAGE			
			MISE EN OEUVRE			Edition C

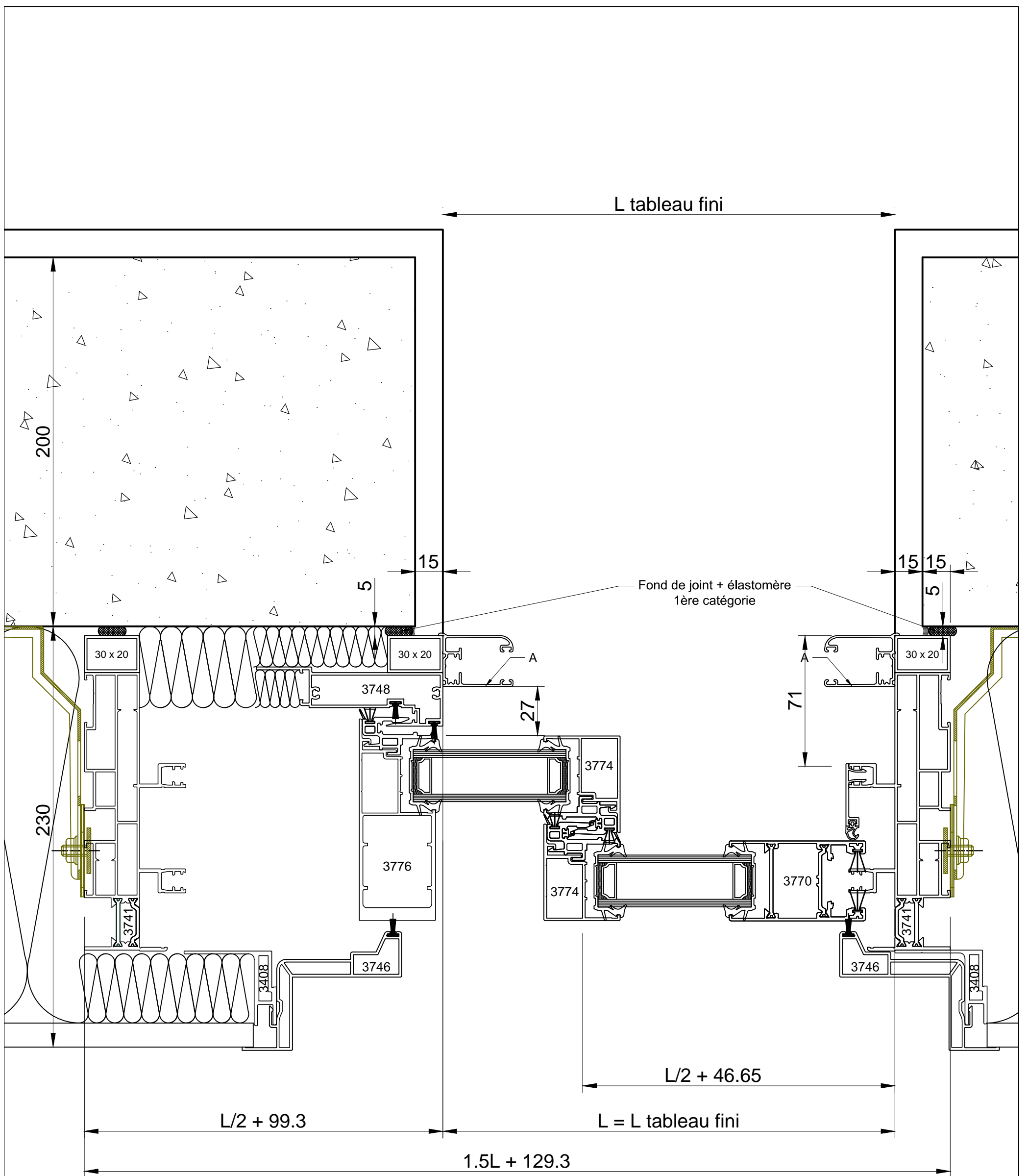

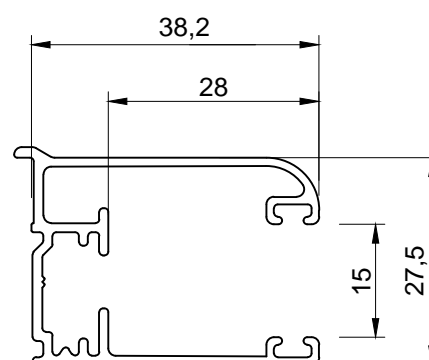

CATA TECH	Dessiné par E. TAVARES	Approuvé par N. BUERMANN	Coupe Horizontale	Modifié le 11/02/2020	Date 28/11/2018	Echelle 1/2 - A3
 Fabricant de Fenêtres et Portes.			COULISSANT A GALANDAGE			
			MISE EN OEUVRE			Edition C

COULISSE MONO : A

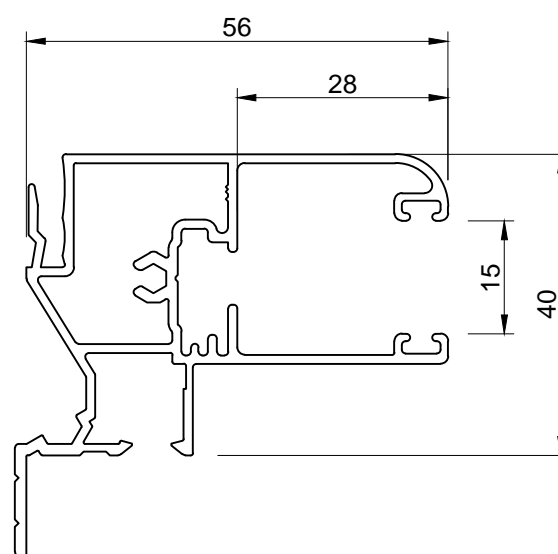

COULISSE RENOVATION : R40



CATA TECH	Dessiné par E. TAVARES	Approuvé par N. BUERMANN	Coupe Verticale	Modifié le 11/02/2020	Date 28/11/2018	Echelle 1/1 - A3
 Fabricant de Fenêtres et Portes.			COULISSES ALUMINIUM			
			MISE EN OEUVRE		Edition C	Feuille No. ALU 84

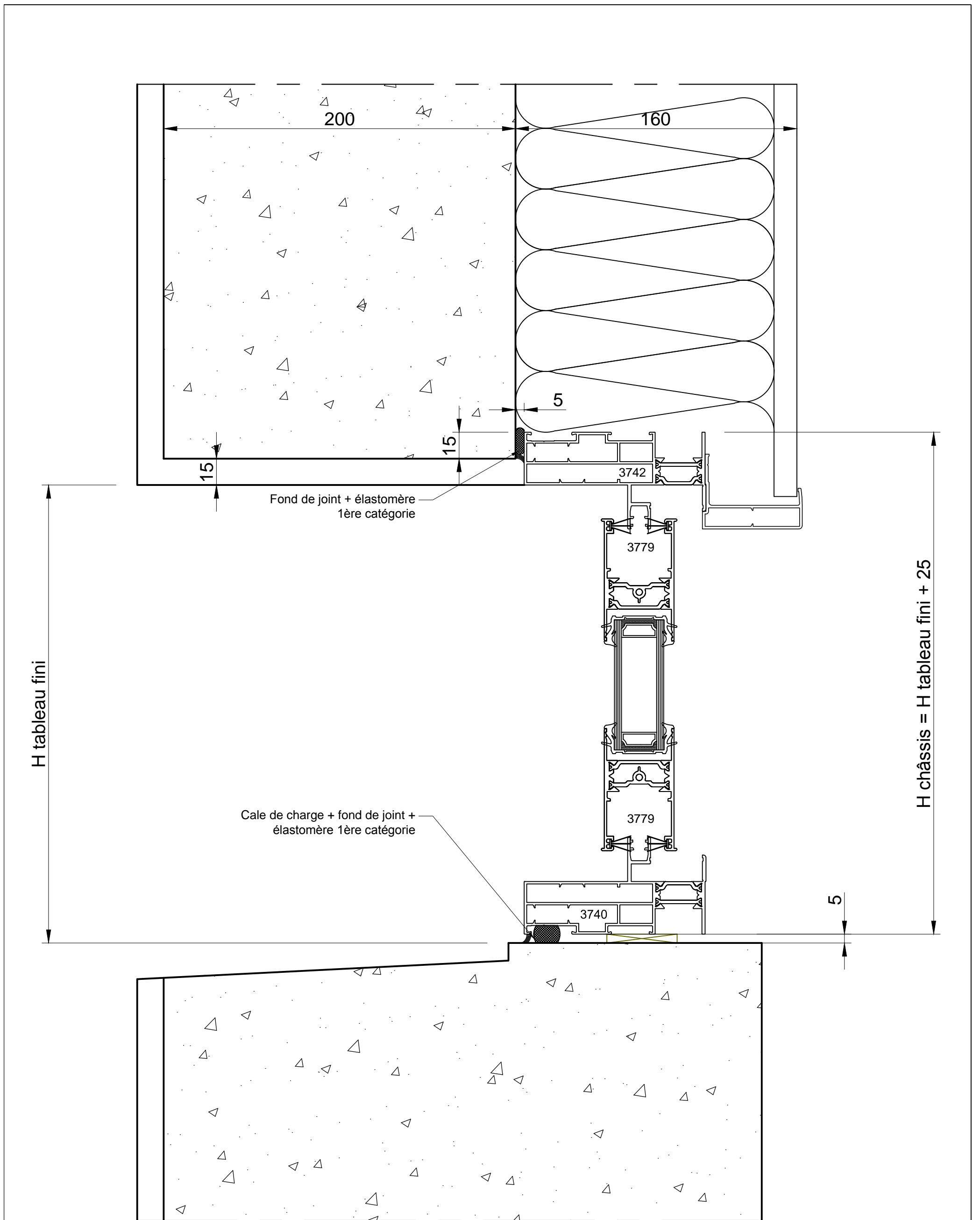

CATA TECH	Dessiné par E. TAVARES	Approuvé par N. BUERMANN	Coupe Verticale	Modifié le 11/02/2020	Date 28/11/2018	Echelle 1/2 - A3
 Fabricant de Fenêtres et Portes.			COULISSANT A GALANDAGE SVR			
			MISE EN OEUVRE			Edition C

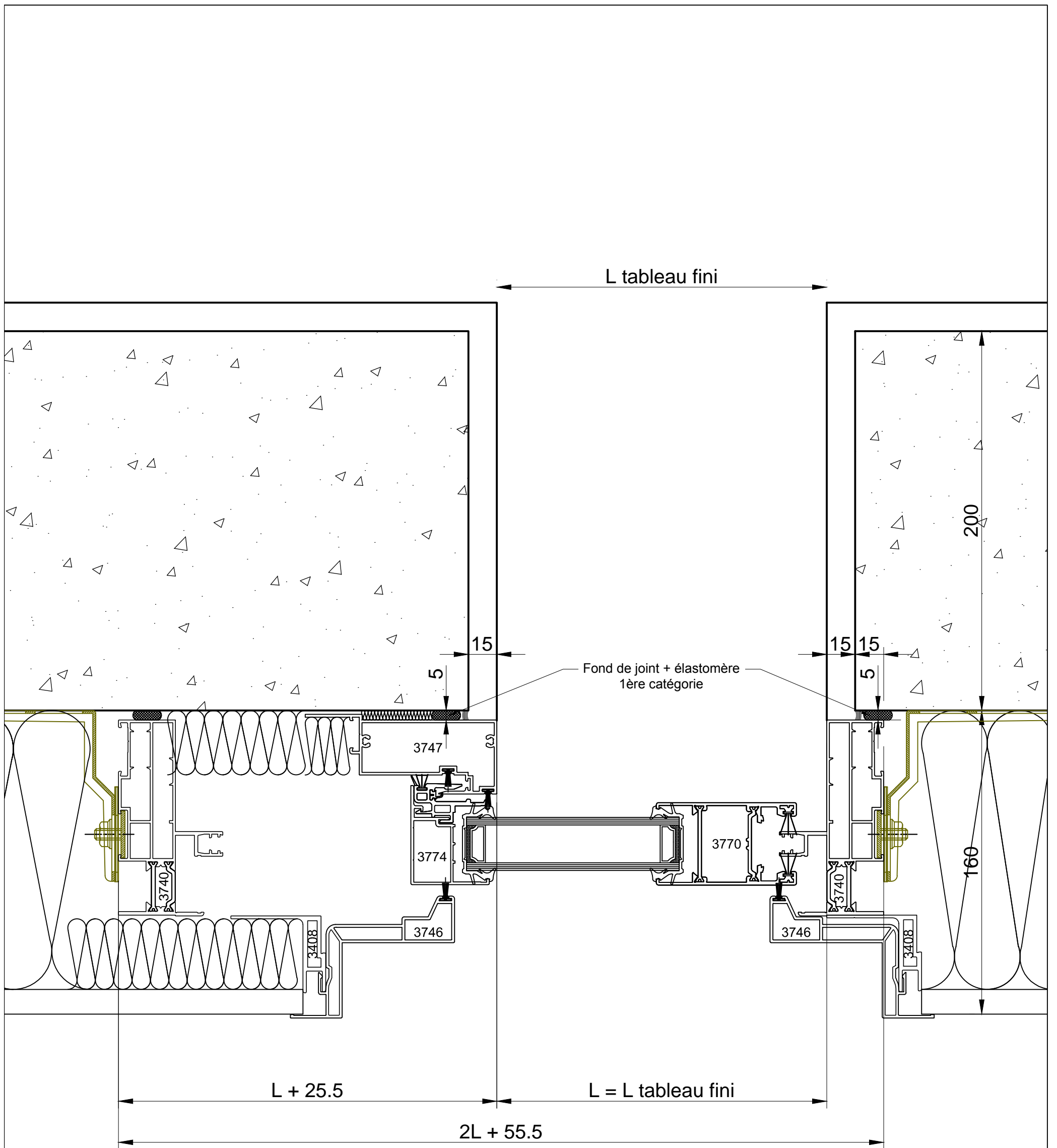

CATA TECH	Dessiné par E. TAVARES	Approuvé par N. BUERMANN	Coupe Horizontale	Modifié le 11/02/2020	Date 28/11/2018	Echelle 1/2 - A3
 Fabricant de Fenêtres et Portes.			COULISSANT A GALANDAGE SVR			
			MISE EN OEUVRE			Edition C

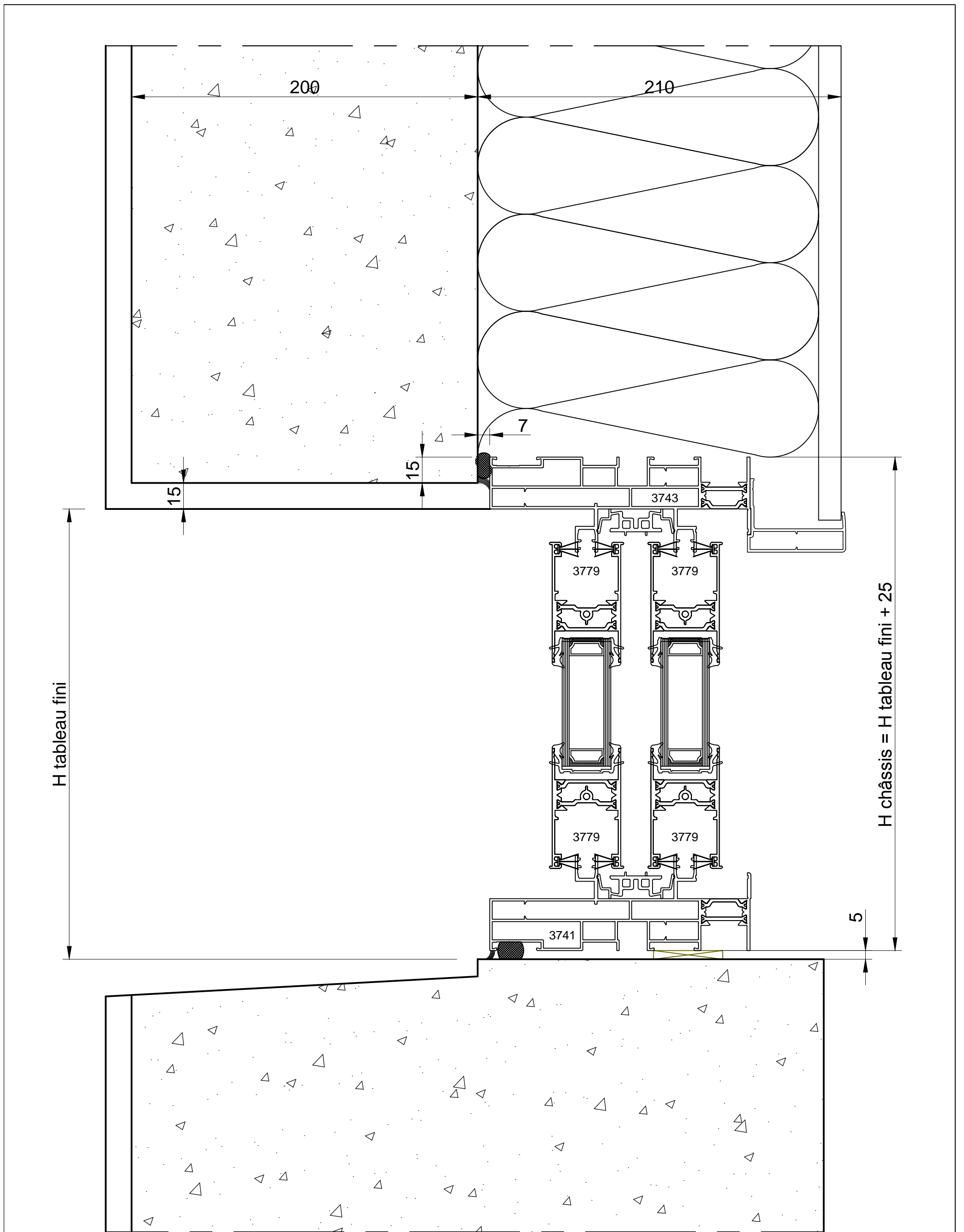

CATA TECH	Dessiné par E. TAVARES	Approuvé par N. BUERMANN	Coupe Verticale	Modifié le 11/02/2020	Date 28/11/2018	Echelle 1/2 - A3
 Fabricant de Fenêtres et Portes.			COULISSANT A GALANDAGE SVR			
			MISE EN OEUVRE	Edition C	Feuille No. ALU 87	

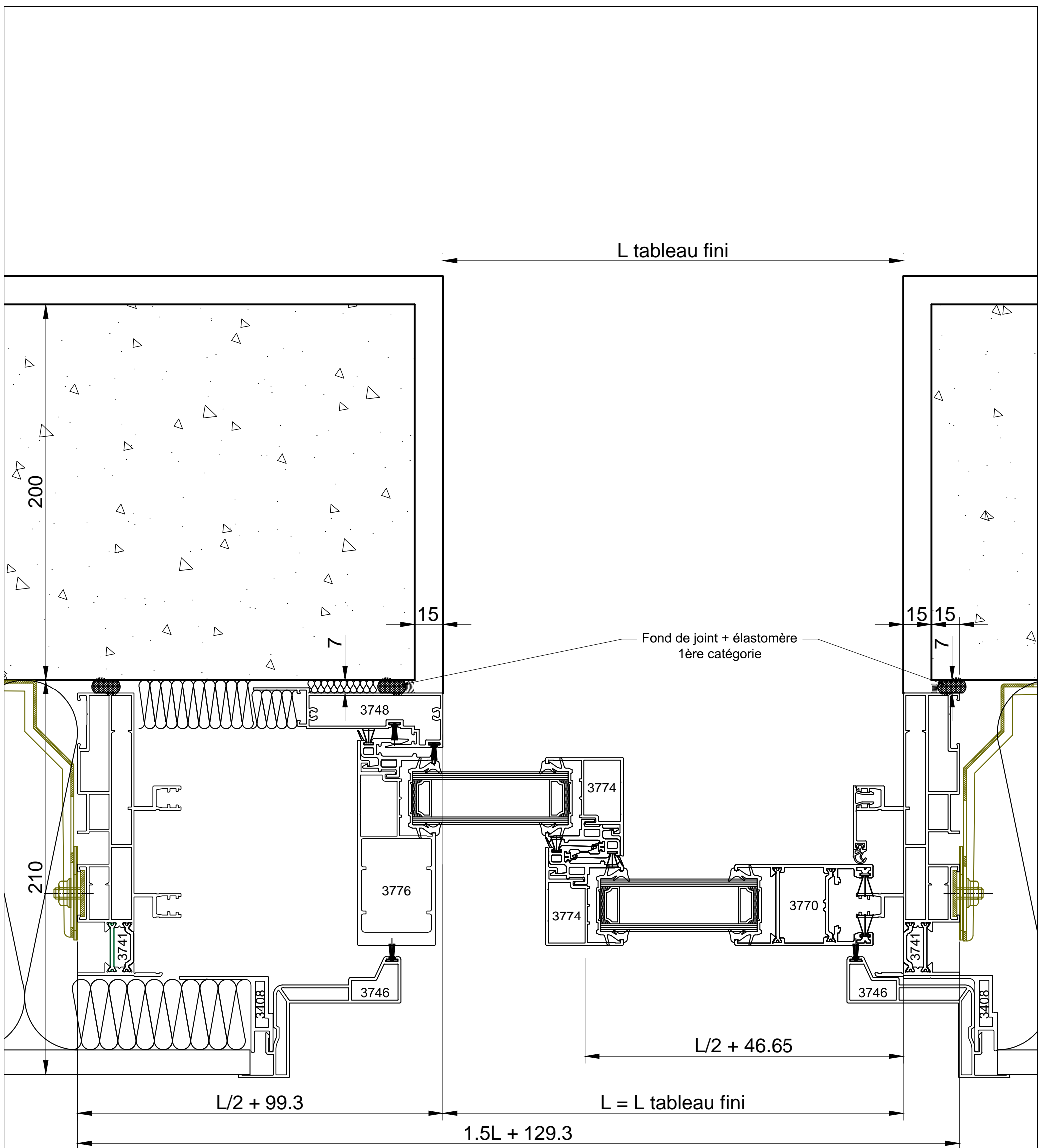

CATA TECH	Dessiné par E. TAVARES	Approuvé par N. BUERMANN	Coupe Horizontale	Modifié le 11/02/2020	Date 28/11/2018	Echelle 1/2 - A3
 Fabricant de Fenêtres et Portes.			COULISSANT A GALANDAGE SVR			
			MISE EN OEUVRE			Edition C

2

Mise en Oeuvre Thermobloc - PVC

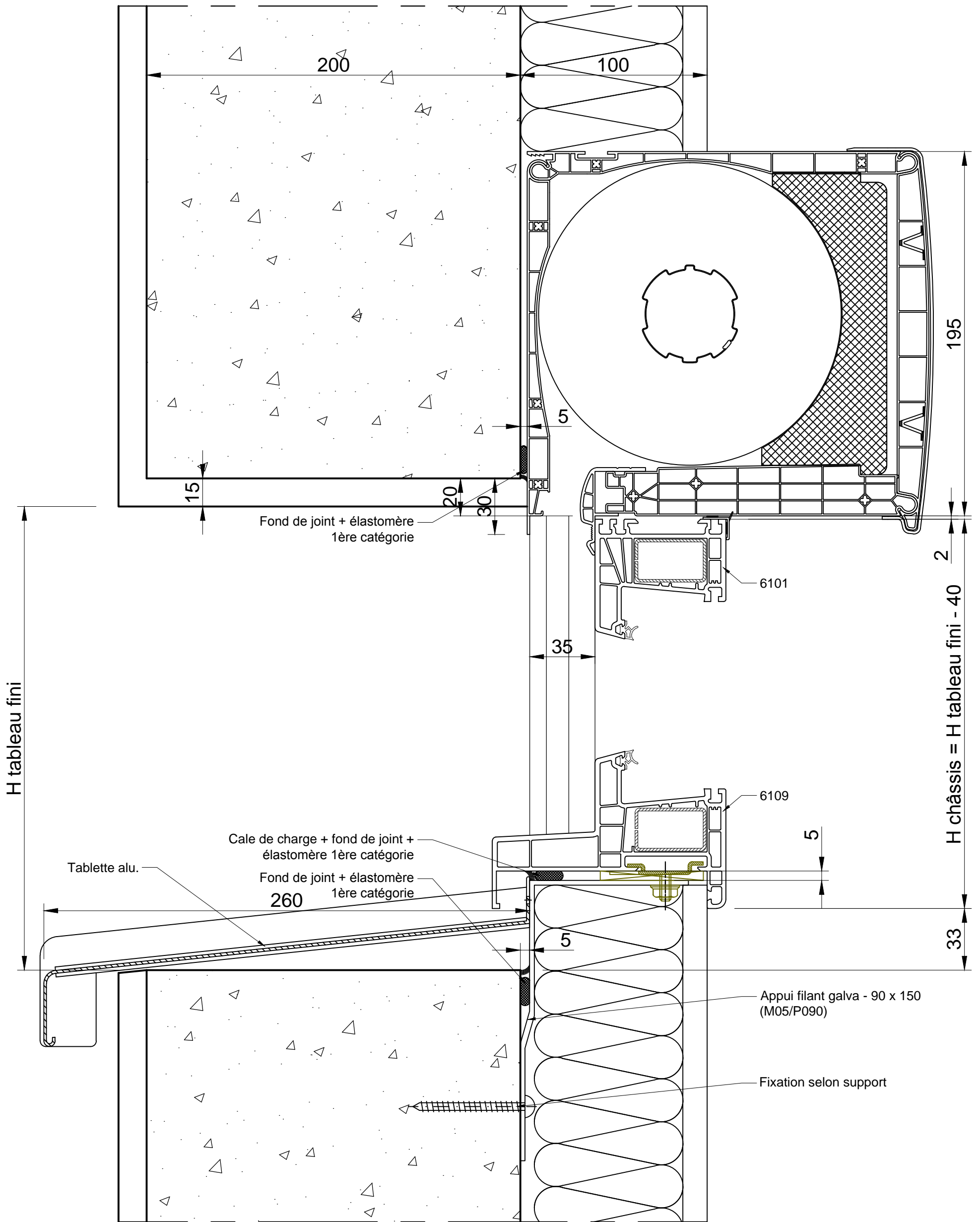

CATA TECH	Dessiné par E. TAVARES	Approuvé par N. BUERMANN	Coupe Verticale	Modifié le 26/11/2018	Date 06/11/2018	Echelle 1/2 - A3
 Fabricant de Fenêtres et Portes.			APPLIQUE RATRAPAGE ISO 100			
			MISE EN OEUVRE			Edition B

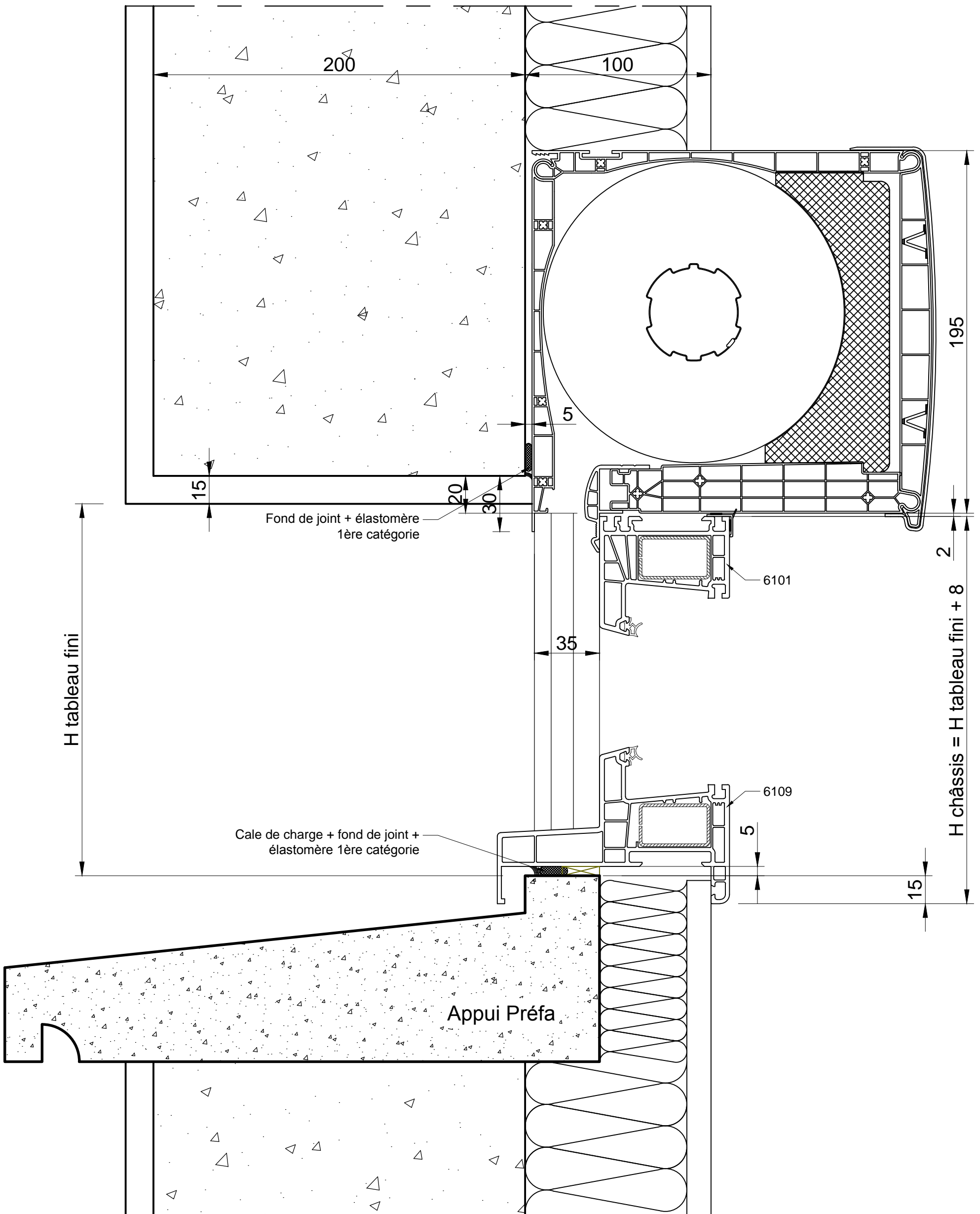

CATA TECH	Dessiné par E. TAVARES	Approuvé par N. BUERMANN	Coupe Verticale	Modifié le 26/11/2018	Date 06/11/2018	Echelle 1/2 - A3
 Fabricant de Fenêtres et Portes.			APPLIQUE RATTRAPAGE ISO 100			
			MISE EN OEUVRE			Edition B

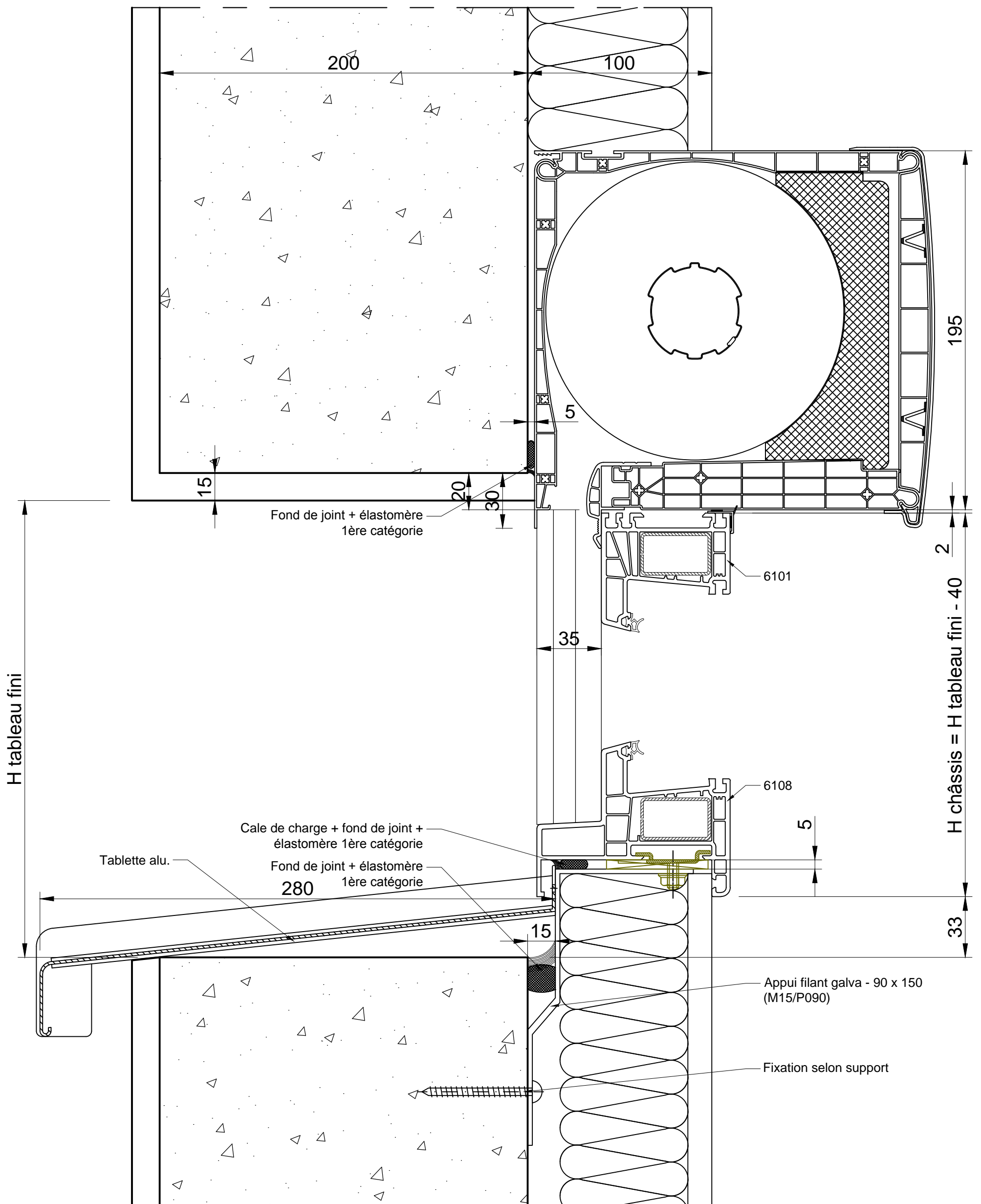

CATA TECH	Dessiné par E. TAVARES	Approuvé par N. BUERMANN	Coupe Verticale	Modifié le 26/11/2018	Date 06/11/2018	Echelle 1/2 - A3
 Fabricant de Fenêtres et Portes.			APPLIQUE RATRAPAGE ISO 100			
			MISE EN OEUVRE			Edition B

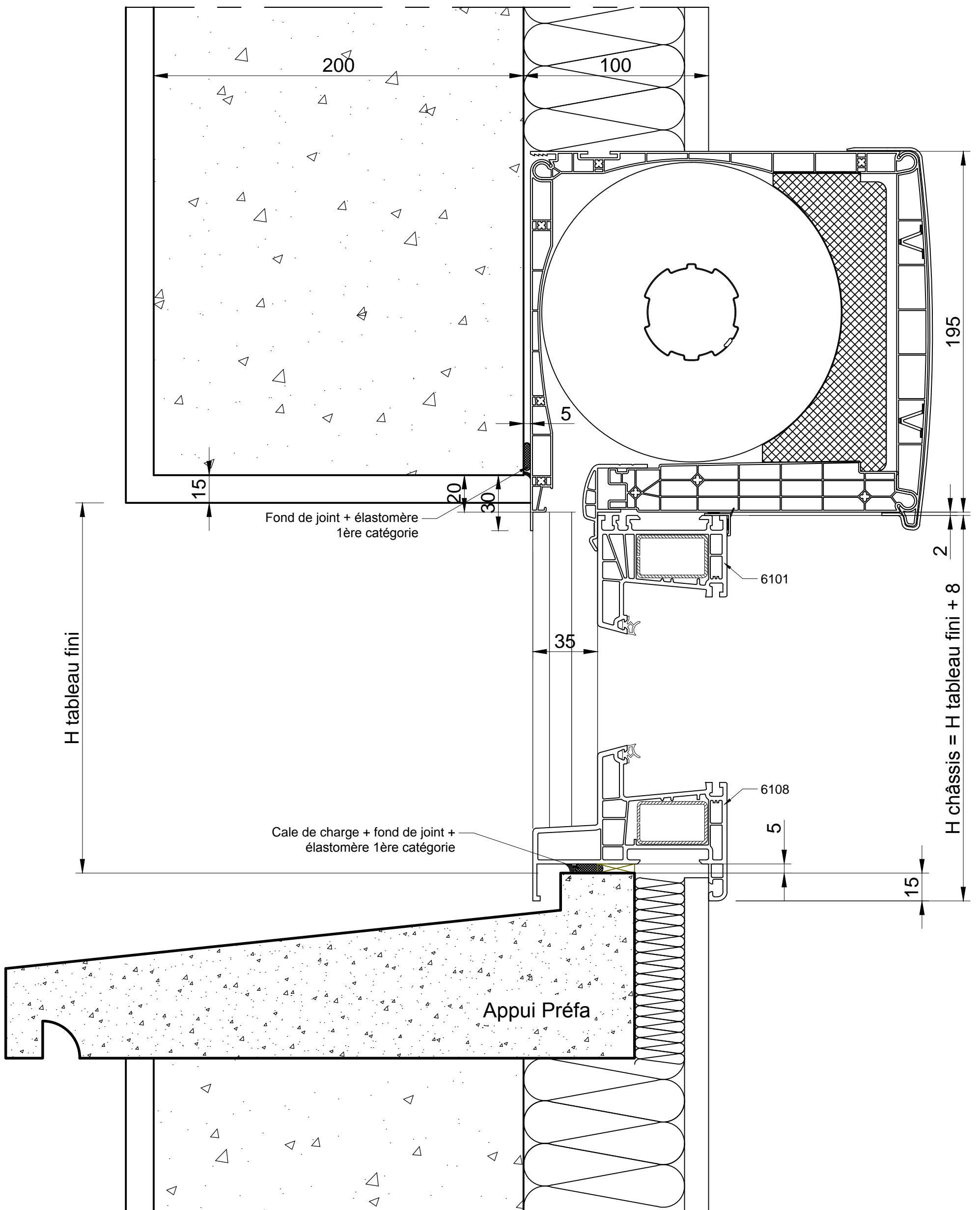

CATA TECH	Dessiné par E. TAVARES	Approuvé par N. BUERMANN	Coupe Verticale	Modifié le 26/11/2018	Date 06/11/2018	Echelle 1/2 - A3
 <p>hilzinger Fabricant de Fenêtres et Portes.</p>			APPLIQUE RATTRAPAGE ISO 100			
			MISE EN OEUVRE			Edition B

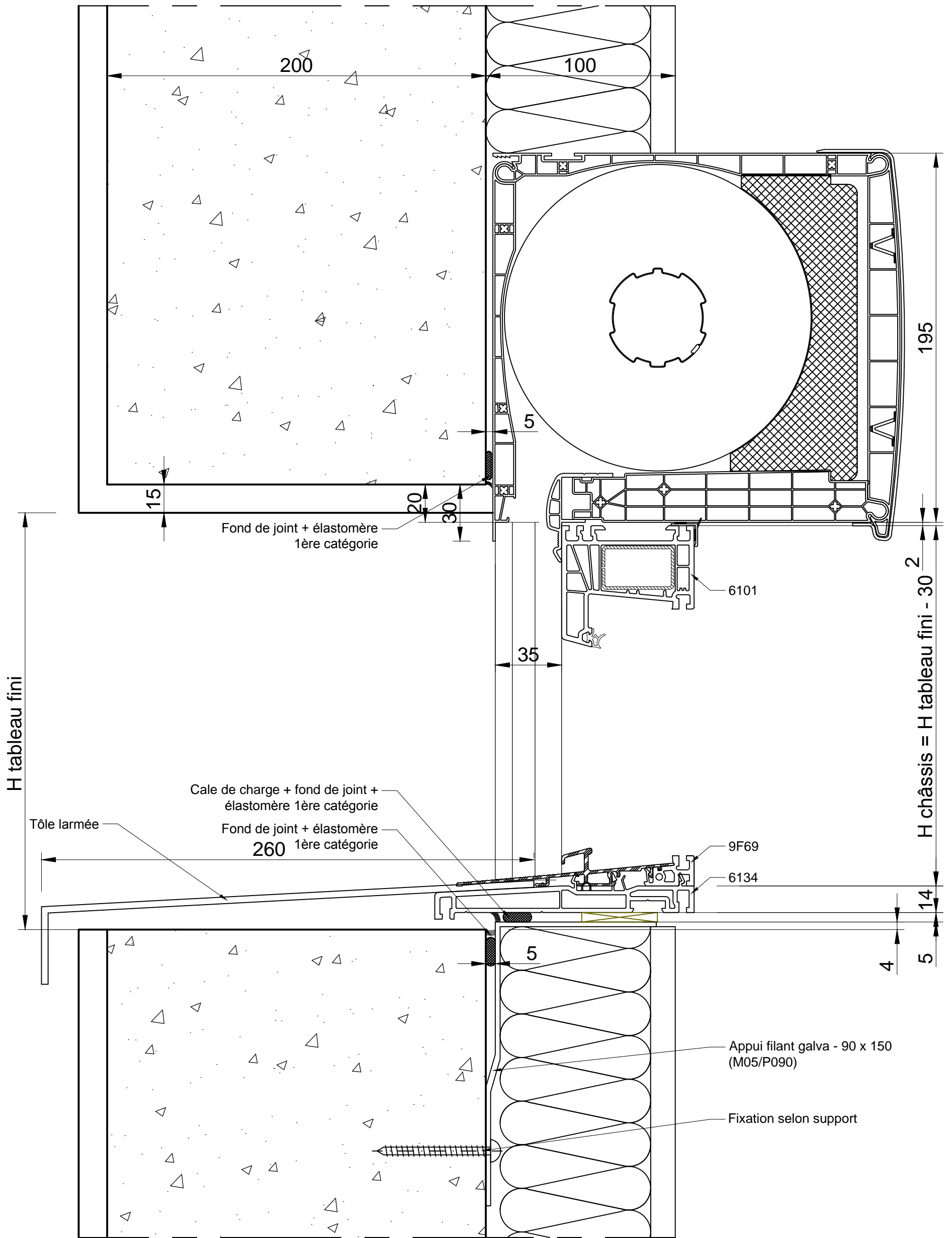

CATA TECH	Dessiné par E. TAVARES	Approuvé par N. BUERMANN	Coupe Verticale	Modifié le 26/11/2018	Date 06/11/2018	Echelle 1/2 - A3
 Fabricant de Fenêtres et Portes.			APPLIQUE RATTRAPAGE ISO 100			
			MISE EN OEUVRE			Edition B

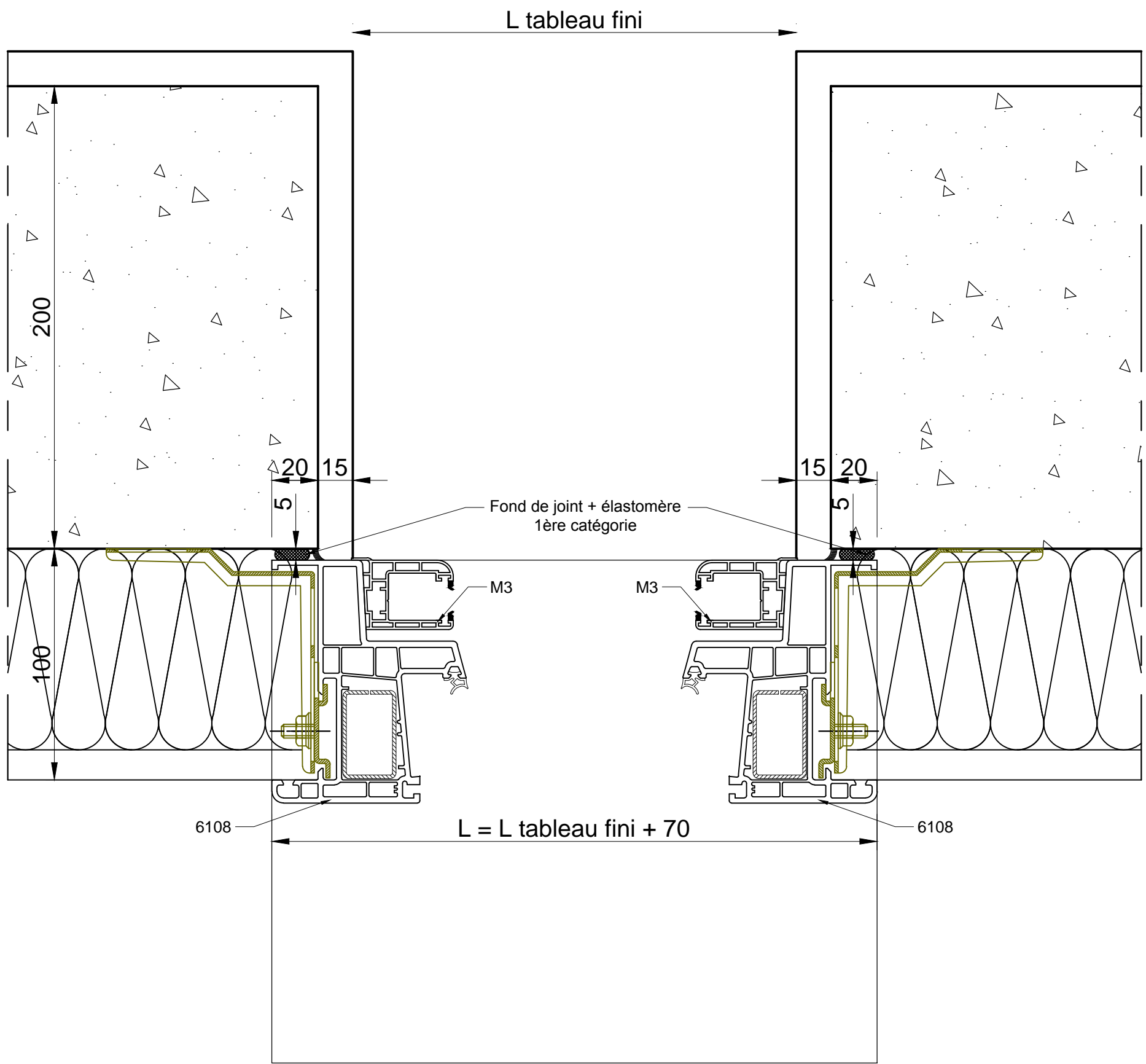

CATA TECH	Dessiné par E. TAVARES	Approuvé par N. BUERMANN	Coupe Verticale	Modifié le 26/11/2018	Date 06/11/2018	Echelle 1/2 - A3
 Fabricant de Fenêtres et Portes.			APPLIQUE RATRAPAGE ISO 100			
			MISE EN OEUVRE			Edition B

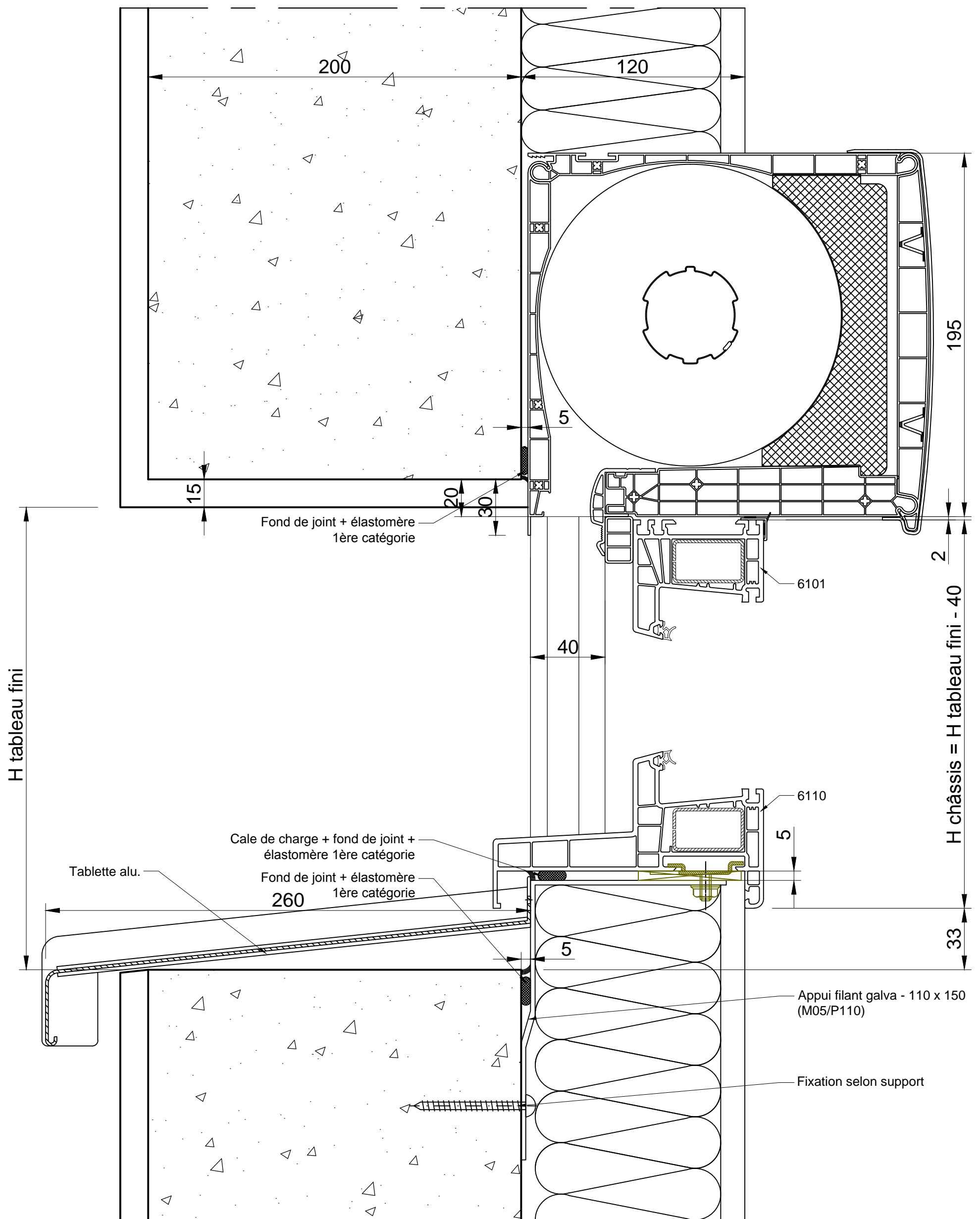

CATA TECH	Dessiné par E. TAVARES	Approuvé par N. BUERMANN	Coupe Verticale	Modifié le 26/11/2018	Date 06/11/2018	Echelle 1/2 - A3
 <p>hilzinger Fabricant de Fenêtres et Portes.</p>			APPLIQUE RATRAPAGE ISO 120			
			MISE EN OEUVRE			Edition B

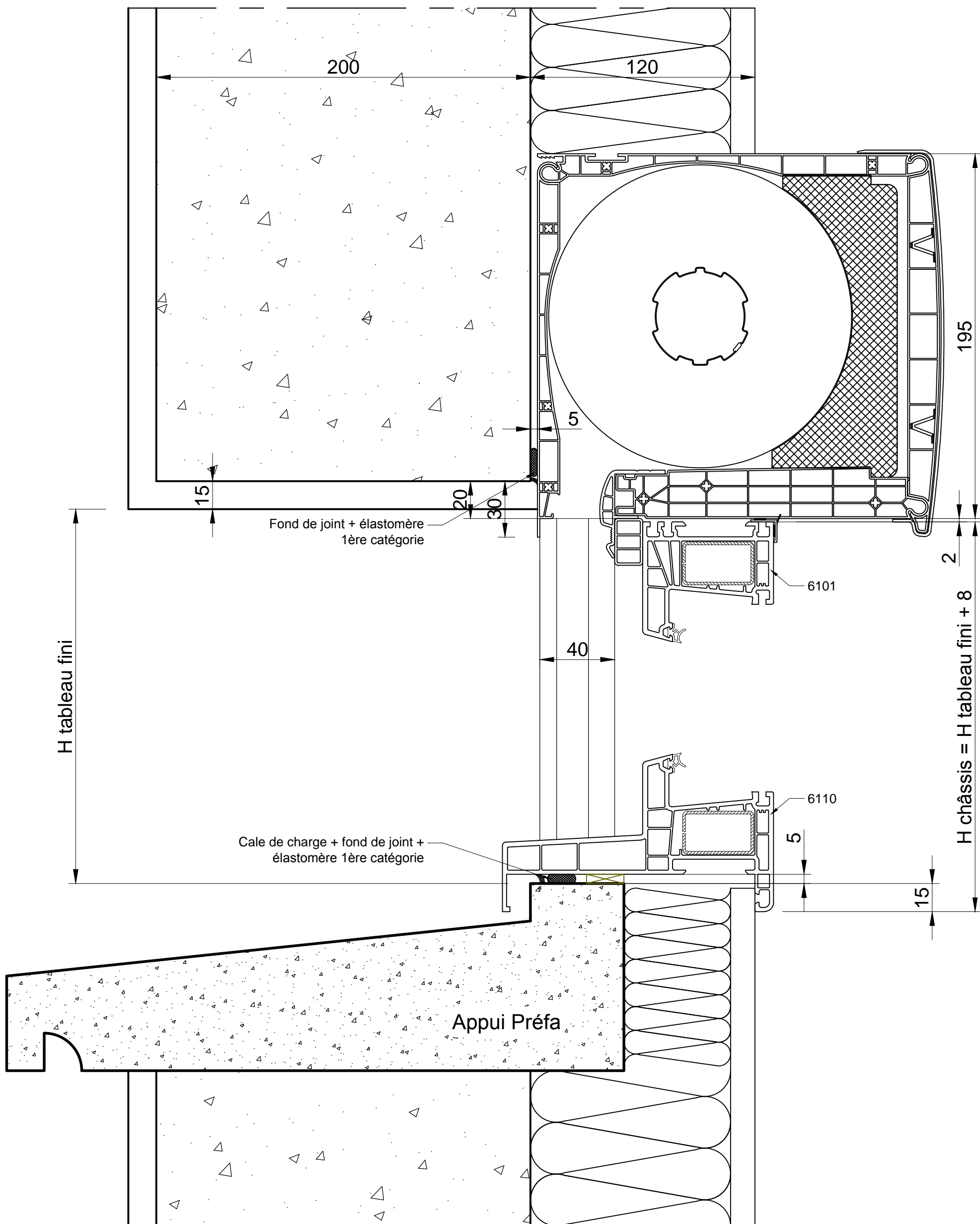

CATA TECH	Dessiné par E. TAVARES	Approuvé par N. BUERMANN	Coupe Verticale	Modifié le 26/11/2018	Date 06/11/2018	Echelle 1/2 - A3
 Fabricant de Fenêtres et Portes.			APPLIQUE RATRAPAGE ISO 120			
			MISE EN OEUVRE			Edition B

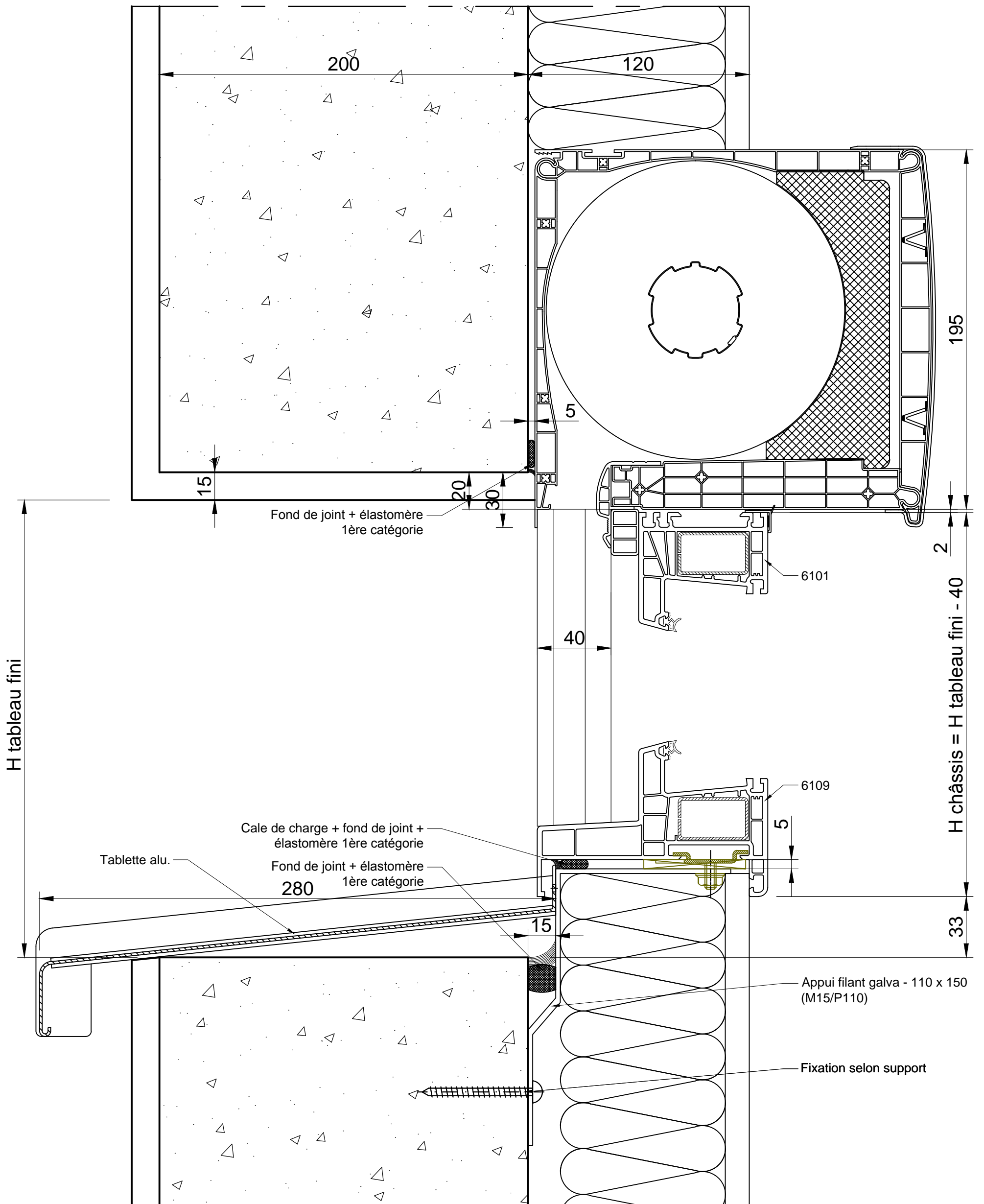

CATA TECH	Dessiné par E. TAVARES	Approuvé par N. BUERMANN	Coupe Verticale	Modifié le 26/11/2018	Date 06/11/2018	Echelle 1/2 - A3
 Fabricant de Fenêtres et Portes.			APPLIQUE RATTRAPAGE ISO 120			
			MISE EN OEUVRE			Edition B

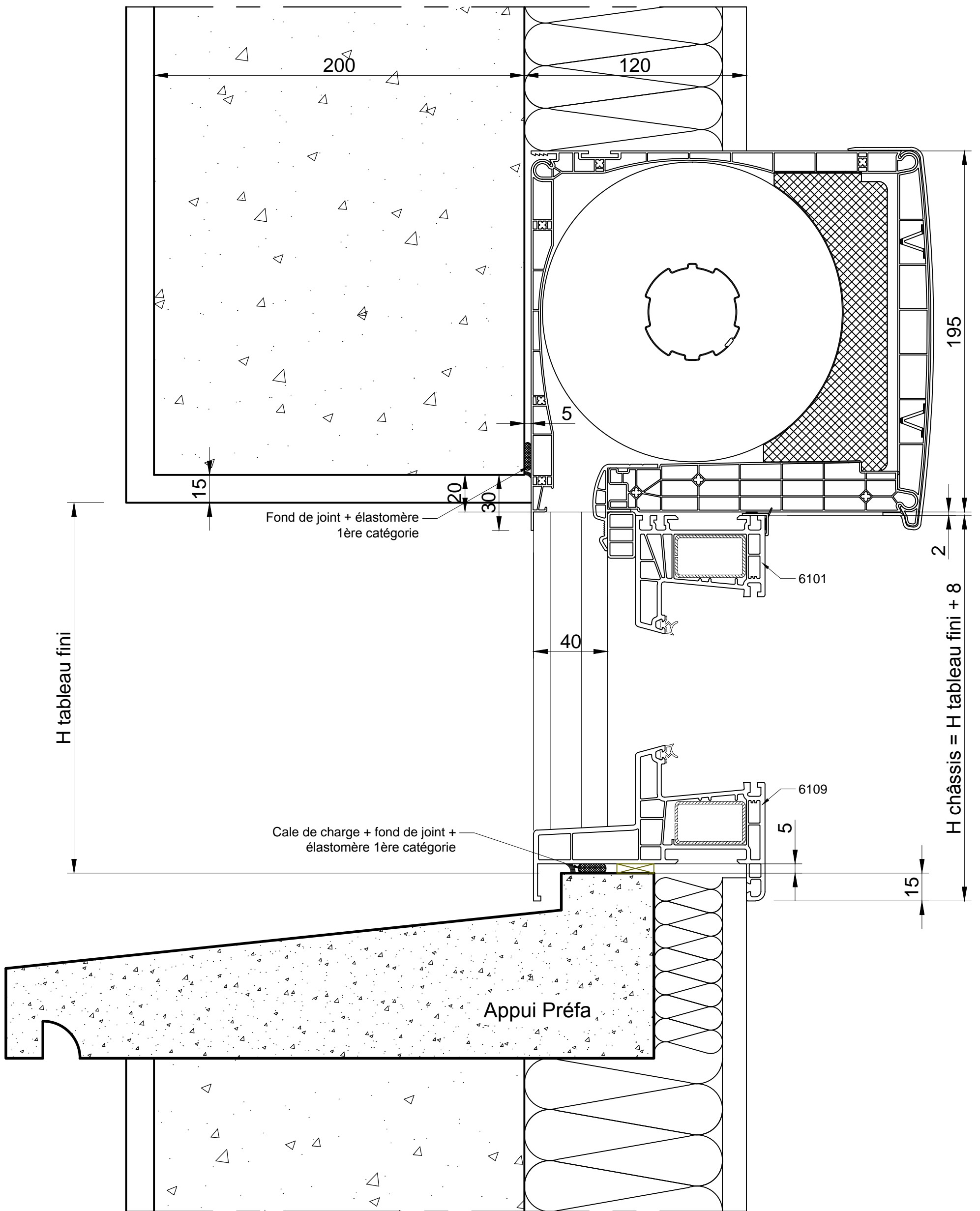

CATA TECH	Dessiné par E. TAVARES	Approuvé par N. BUERMANN	Coupe Verticale	Modifié le 26/11/2018	Date 06/11/2018	Echelle 1/2 - A3
 Fabricant de Fenêtres et Portes.			APPLIQUE RATRAPAGE ISO 120			
			MISE EN OEUVRE			Edition B

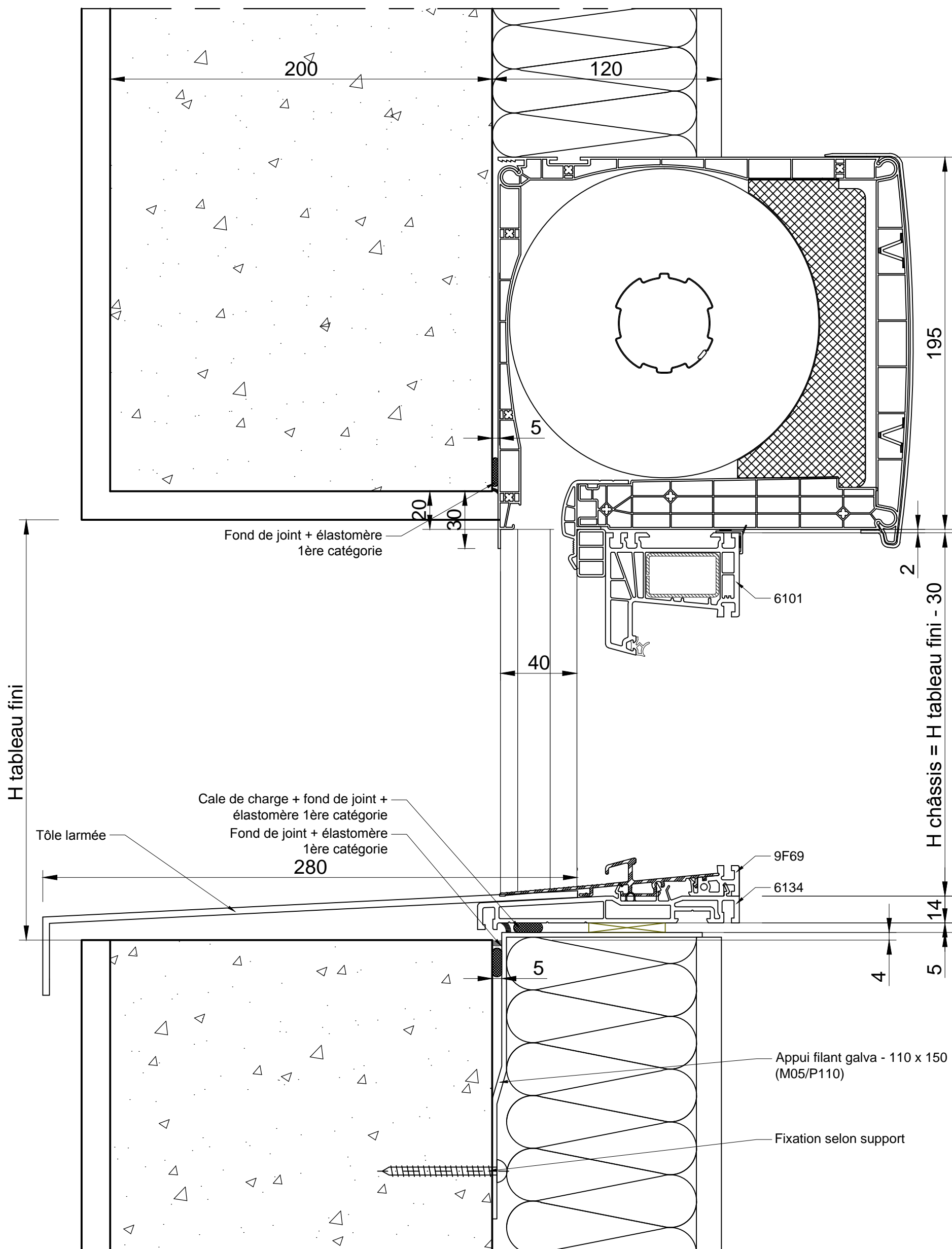

CATA TECH	Dessiné par E. TAVARES	Approuvé par N. BUERMANN	Coupe Verticale	Modifié le 26/11/2018	Date 06/11/2018	Echelle 1/2 - A3
 Fabricant de Fenêtres et Portes.			APPLIQUE RATTRAPAGE ISO 120			
			MISE EN OEUVRE			Edition B

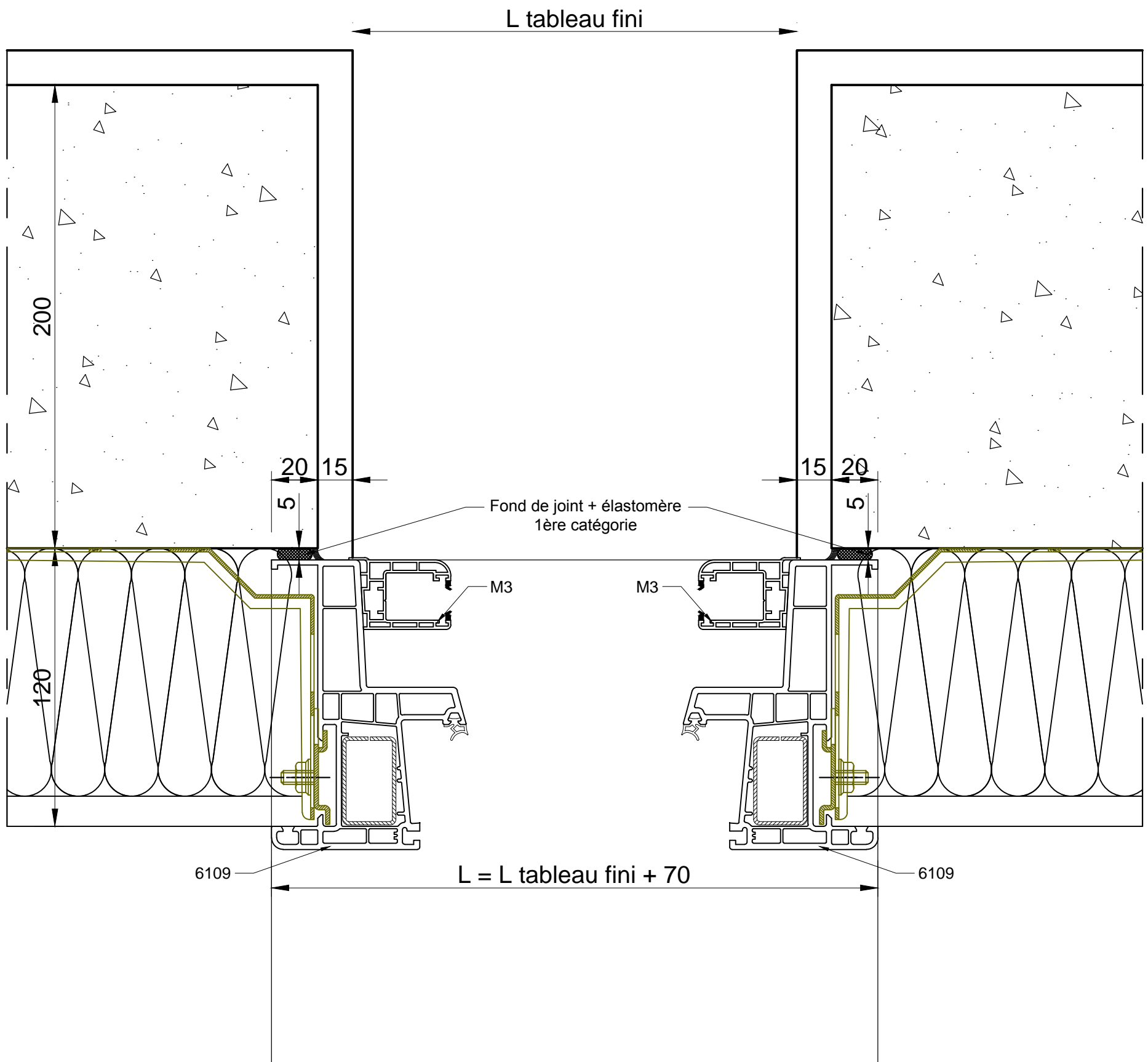

CATA TECH	Dessiné par E. TAVARES	Approuvé par N. BUERMANN	Coupe Verticale	Modifié le 26/11/2018	Date 06/11/2018	Echelle 1/2 - A3
 Fabricant de Fenêtres et Portes.			APPLIQUE RATRAPAGE ISO 120			
			MISE EN OEUVRE			Edition B

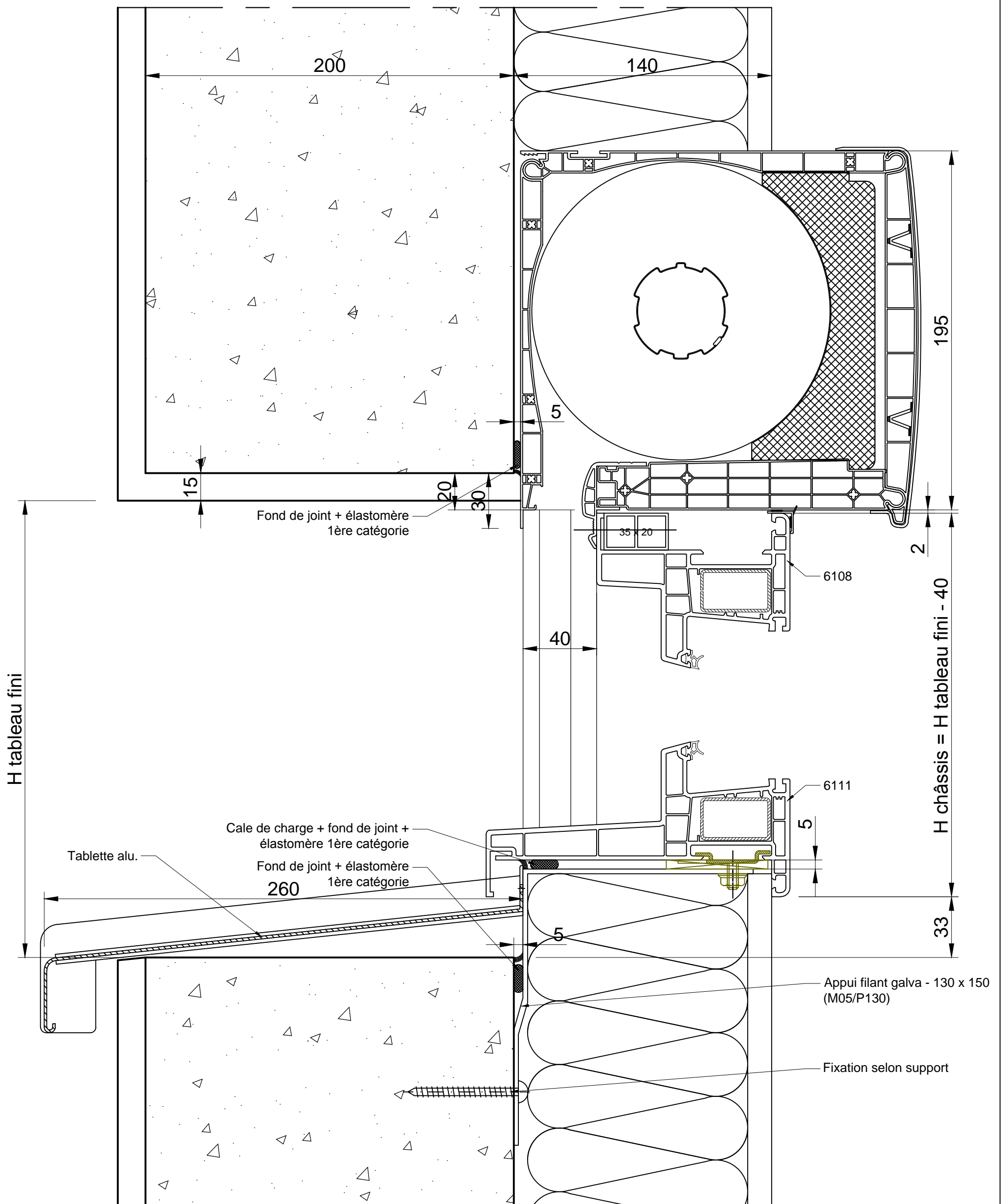

CATA TECH	Dessiné par E. TAVARES	Approuvé par N. BUERMANN	Coupe Verticale	Modifié le 26/11/2018	Date 06/11/2018	Echelle 1/2 - A3
 <p>hilzinger Fabricant de Fenêtres et Portes.</p>			APPLIQUE RATTRAPAGE ISO 140			
			MISE EN OEUVRE			Edition B

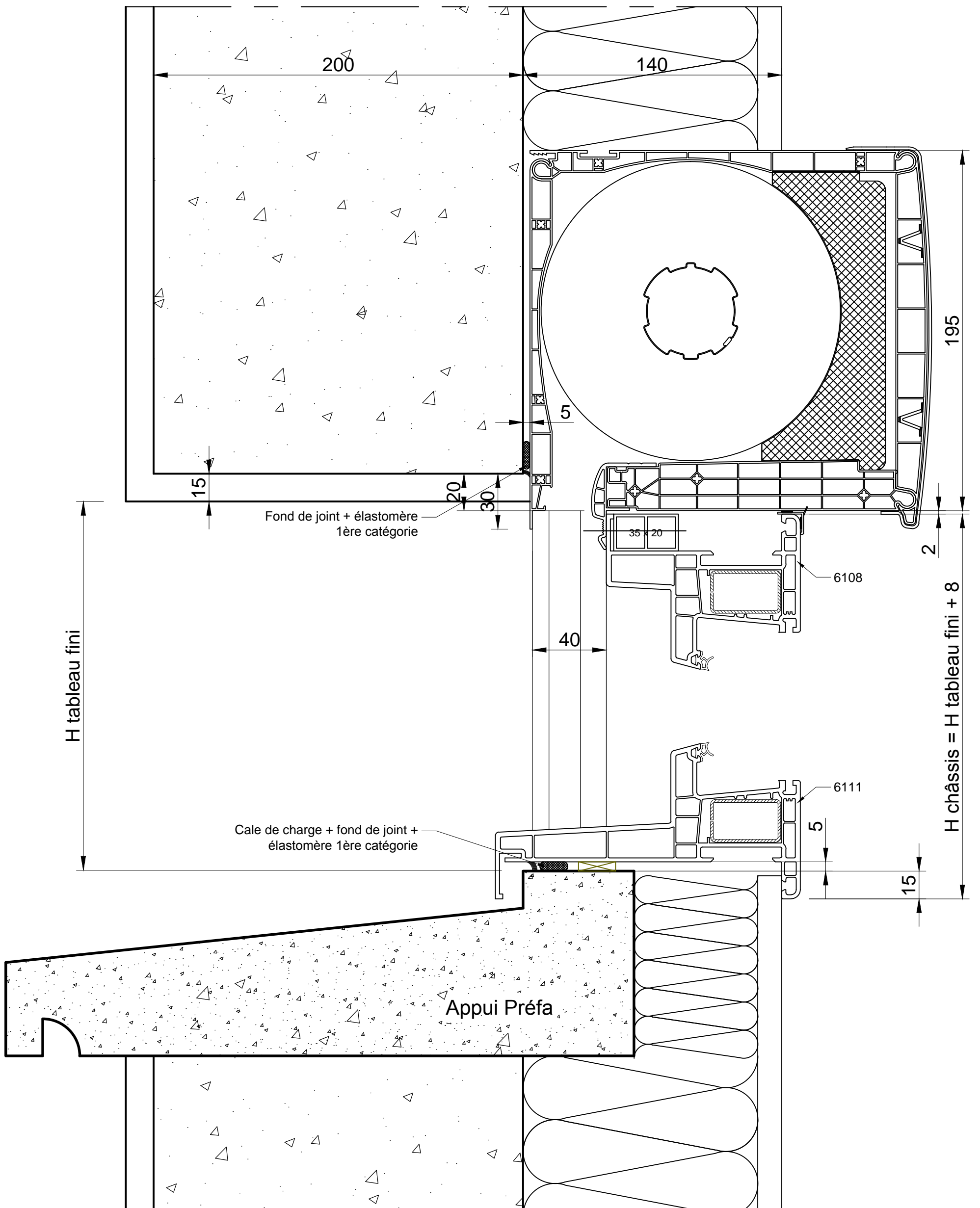

CATA TECH	Dessiné par E. TAVARES	Approuvé par N. BUERMANN	Coupe Verticale	Modifié le 26/11/2018	Date 06/11/2018	Echelle 1/2 - A3
 Fabricant de Fenêtres et Portes.			APPLIQUE RATRAPAGE ISO 140			
			MISE EN OEUVRE			Edition B

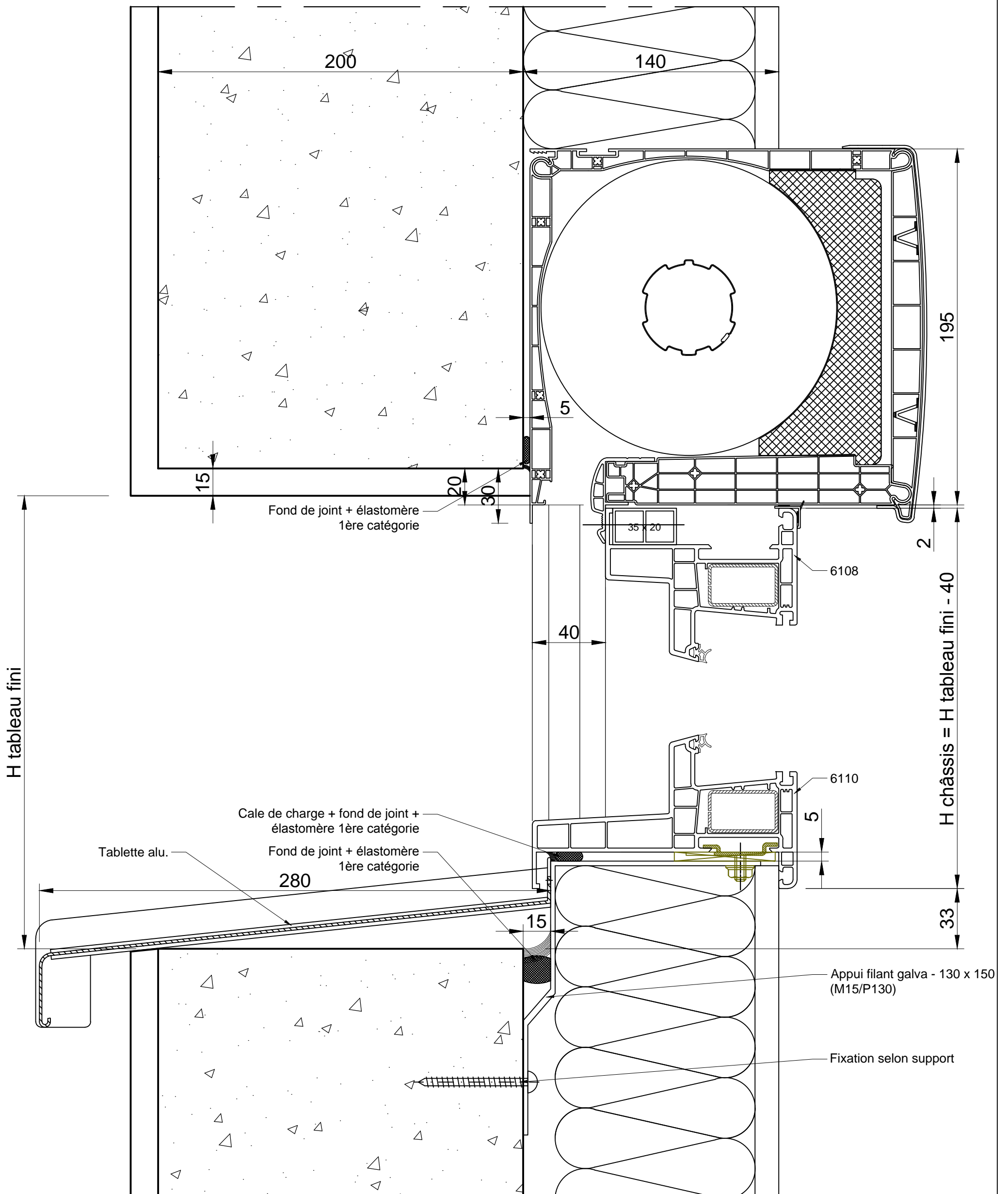

CATA TECH	Dessiné par E. TAVARES	Approuvé par N. BUERMANN	Coupe Verticale	Modifié le 26/11/2018	Date 06/11/2018	Echelle 1/2 - A3
 Fabricant de Fenêtres et Portes.			APPLIQUE RATTRAPAGE ISO 140			
			MISE EN OEUVRE			Edition B

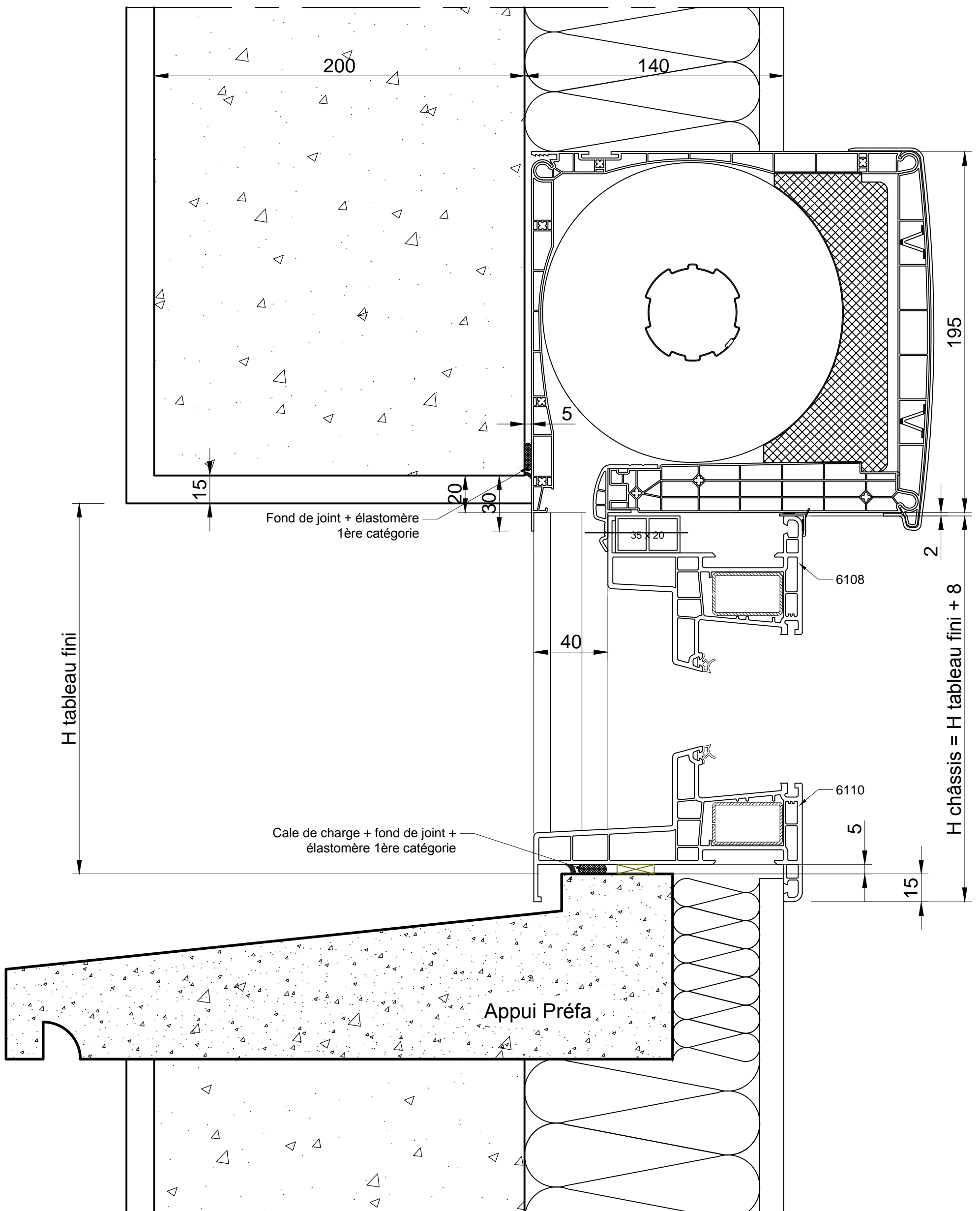

CATA TECH	Dessiné par E. TAVARES	Approuvé par N. BUERMANN	Coupe Verticale	Modifié le 26/11/2018	Date 06/11/2018	Echelle 1/2 - A3
 Fabricant de Fenêtres et Portes.			APPLIQUE RATTRAPAGE ISO 140			
			MISE EN OEUVRE			Edition B

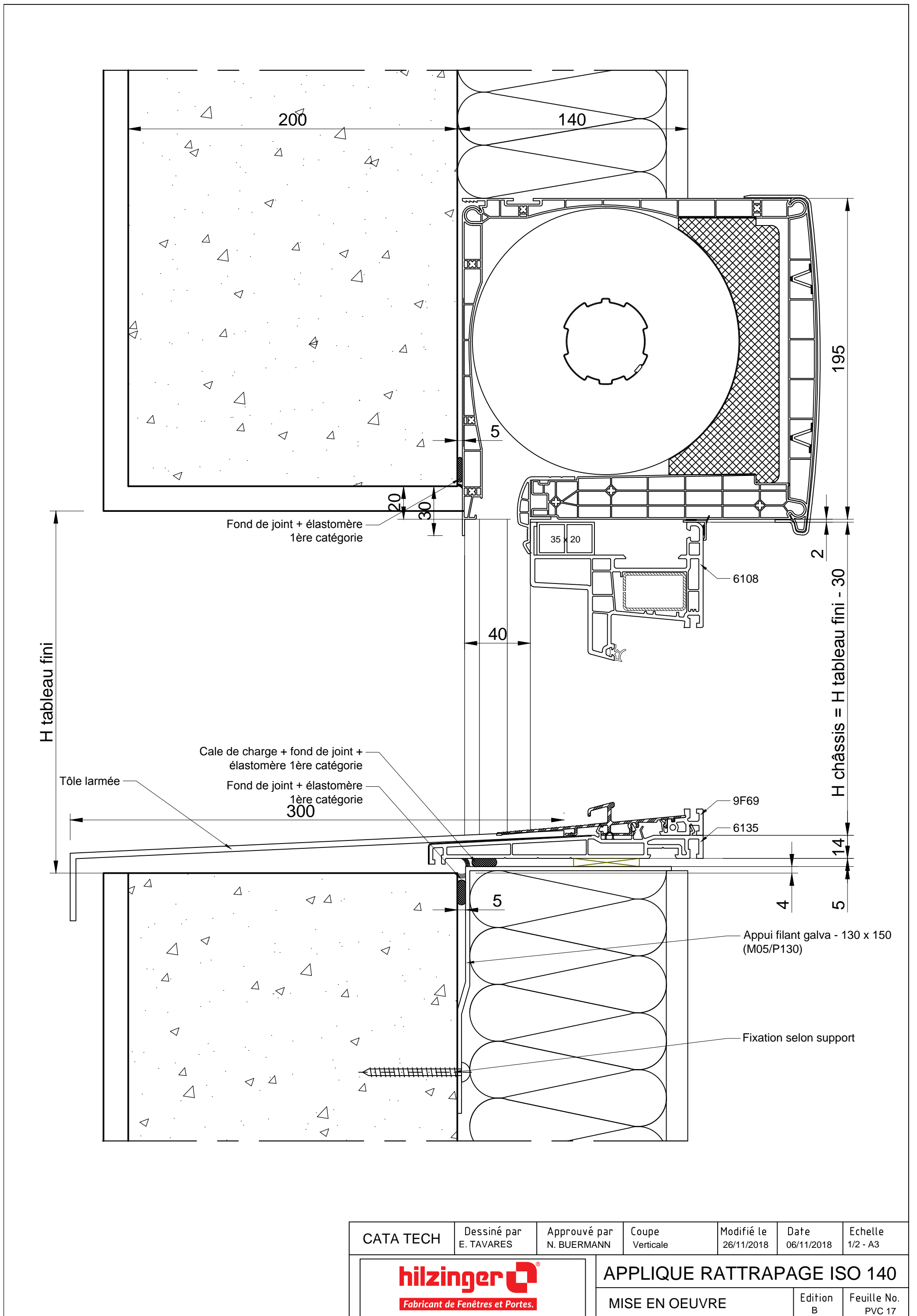

CATA TECH	Dessiné par E. TAVARES	Approuvé par N. BUERMANN	Coupe Verticale	Modifié le 26/11/2018	Date 06/11/2018	Echelle 1/2 - A3
 Fabricant de Fenêtres et Portes.			APPLIQUE RATTRAPAGE ISO 140			
			MISE EN OEUVRE			Edition B

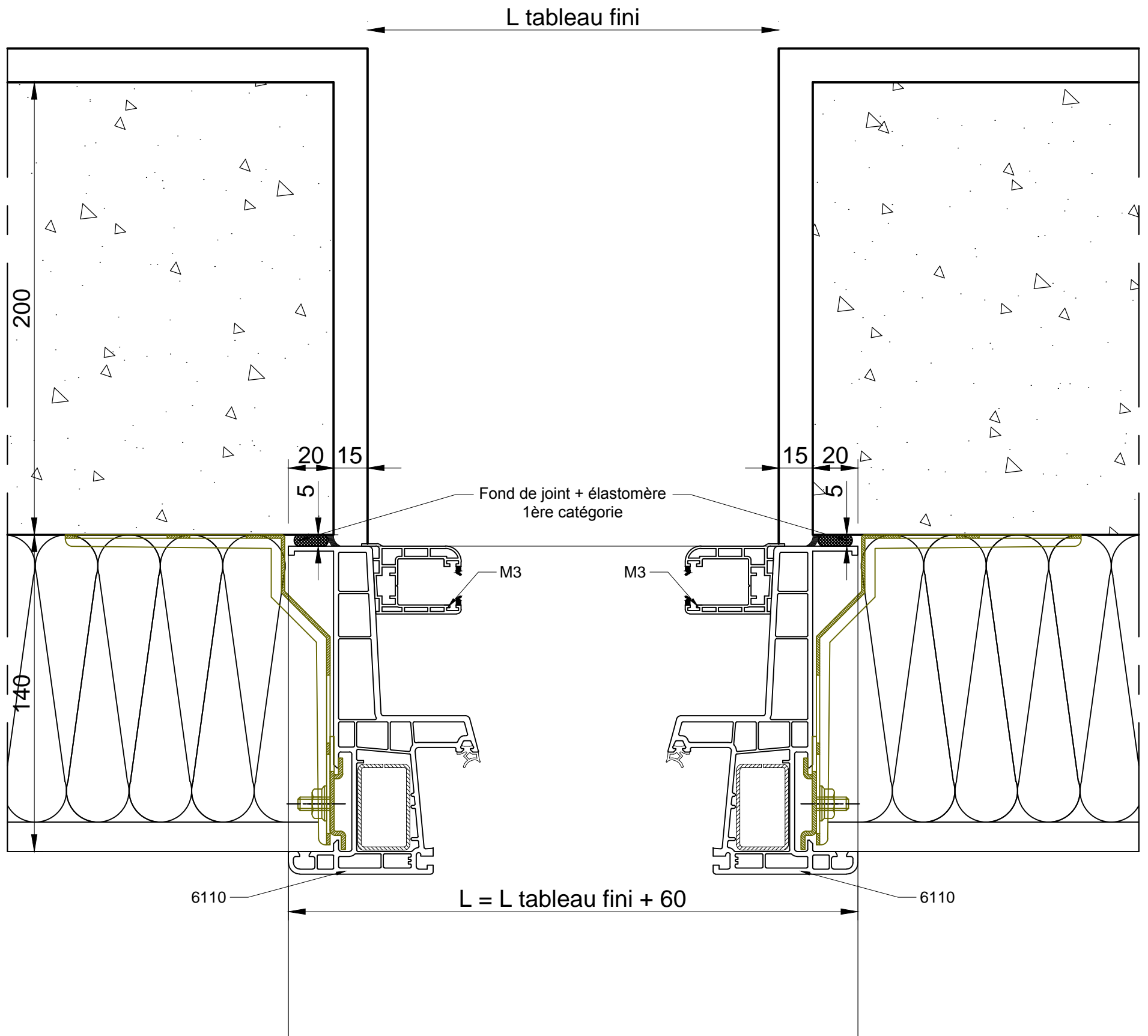

CATA TECH	Dessiné par E. TAVARES	Approuvé par N. BUERMANN	Coupe Verticale	Modifié le 26/11/2018	Date 06/11/2018	Echelle 1/2 - A3
 Fabricant de Fenêtres et Portes.			APPLIQUE RATTRAPAGE ISO 140			
			MISE EN OEUVRE			Edition B

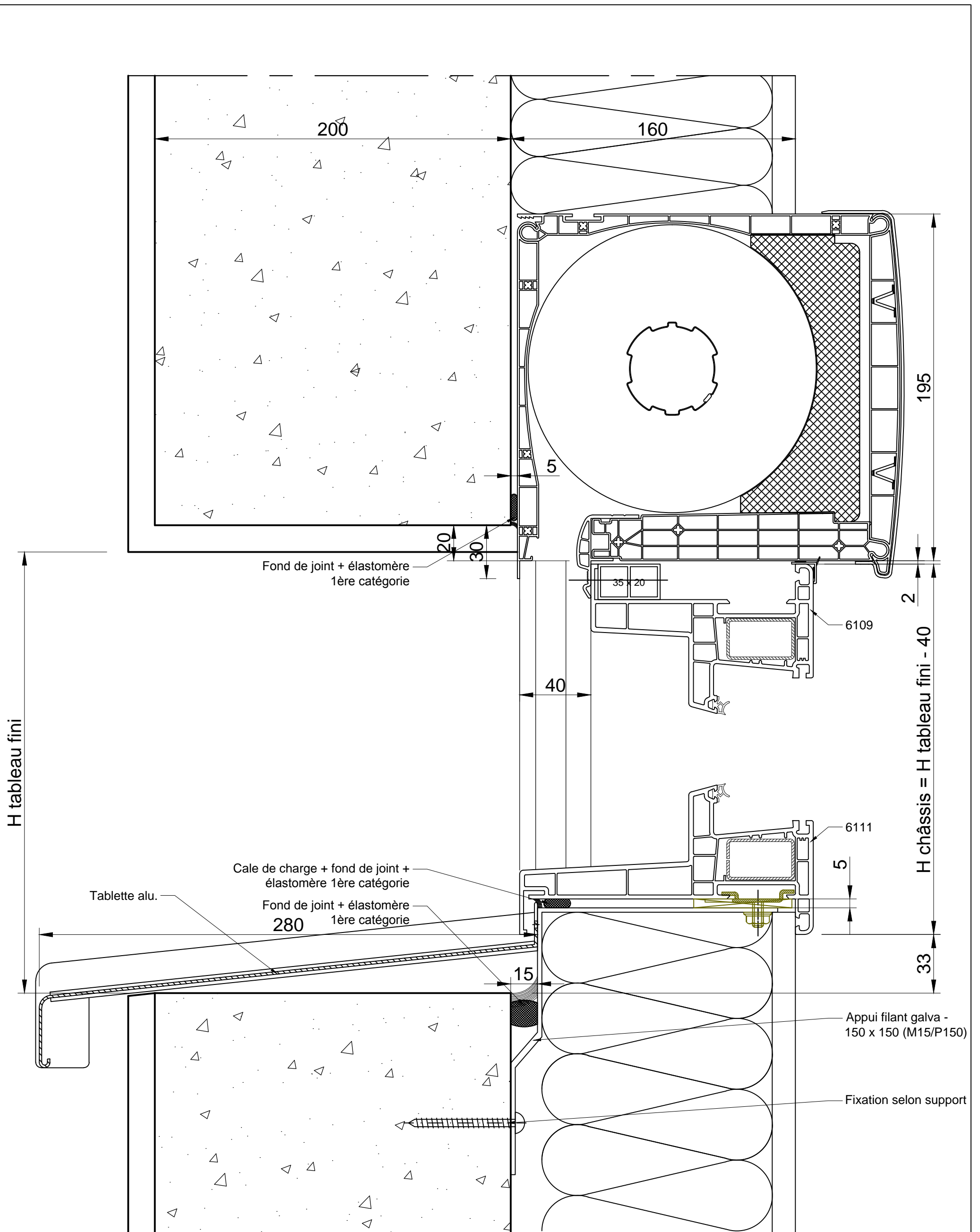

CATA TECH	Dessiné par E. TAVARES	Approuvé par N. BUERMANN	Coupe Verticale	Modifié le 26/11/2018	Date 06/11/2018	Echelle 1/2 - A3
 Fabricant de Fenêtres et Portes.			APPLIQUE RATTRAPAGE ISO 160			
			MISE EN OEUVRE			Edition B

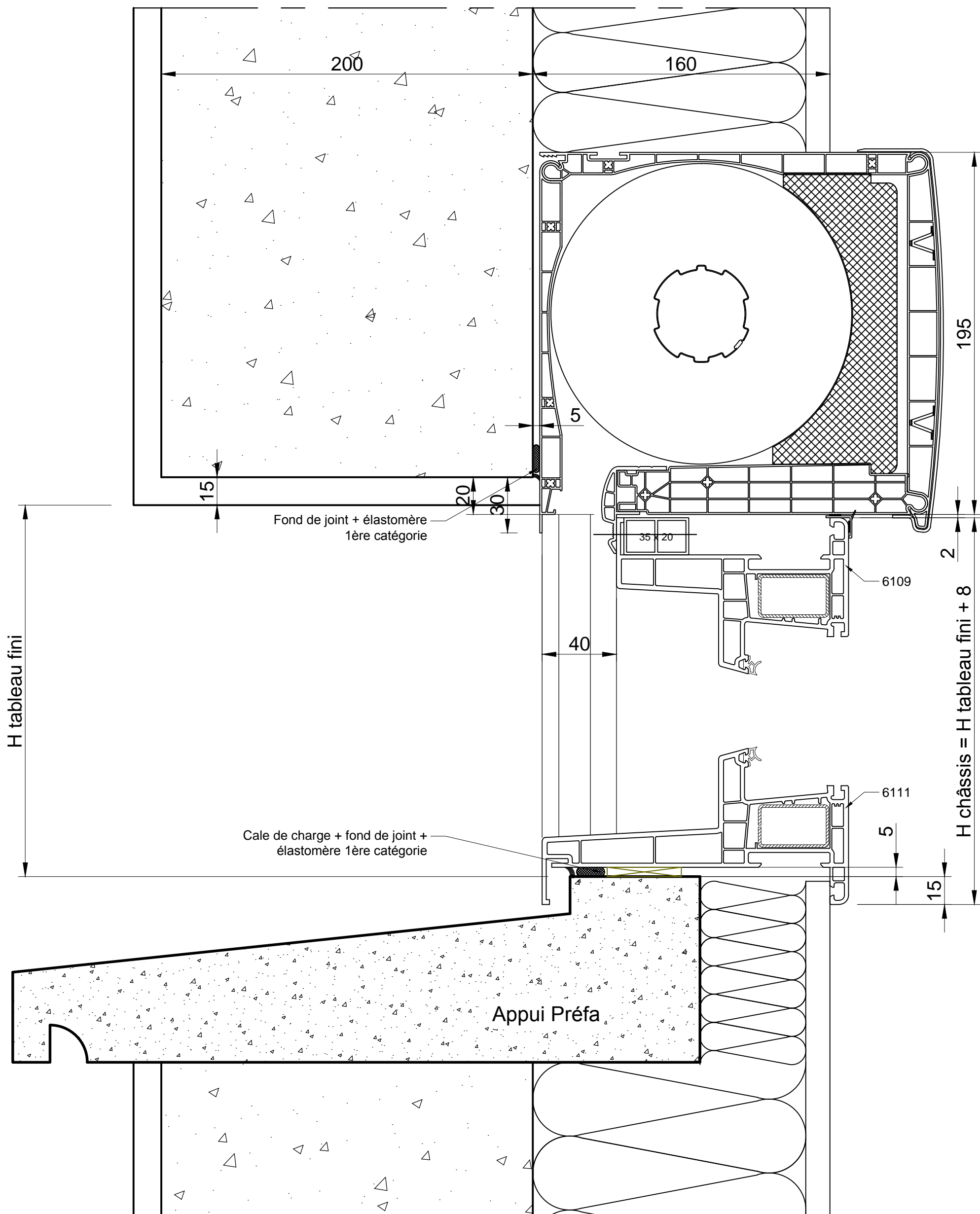

CATA TECH	Dessiné par E. TAVARES	Approuvé par N. BUERMANN	Coupe Verticale	Modifié le 26/11/2018	Date 06/11/2018	Echelle 1/2 - A3
 Fabricant de Fenêtres et Portes.			APPLIQUE RATRAPAGE ISO 160			
			MISE EN OEUVRE			Edition B

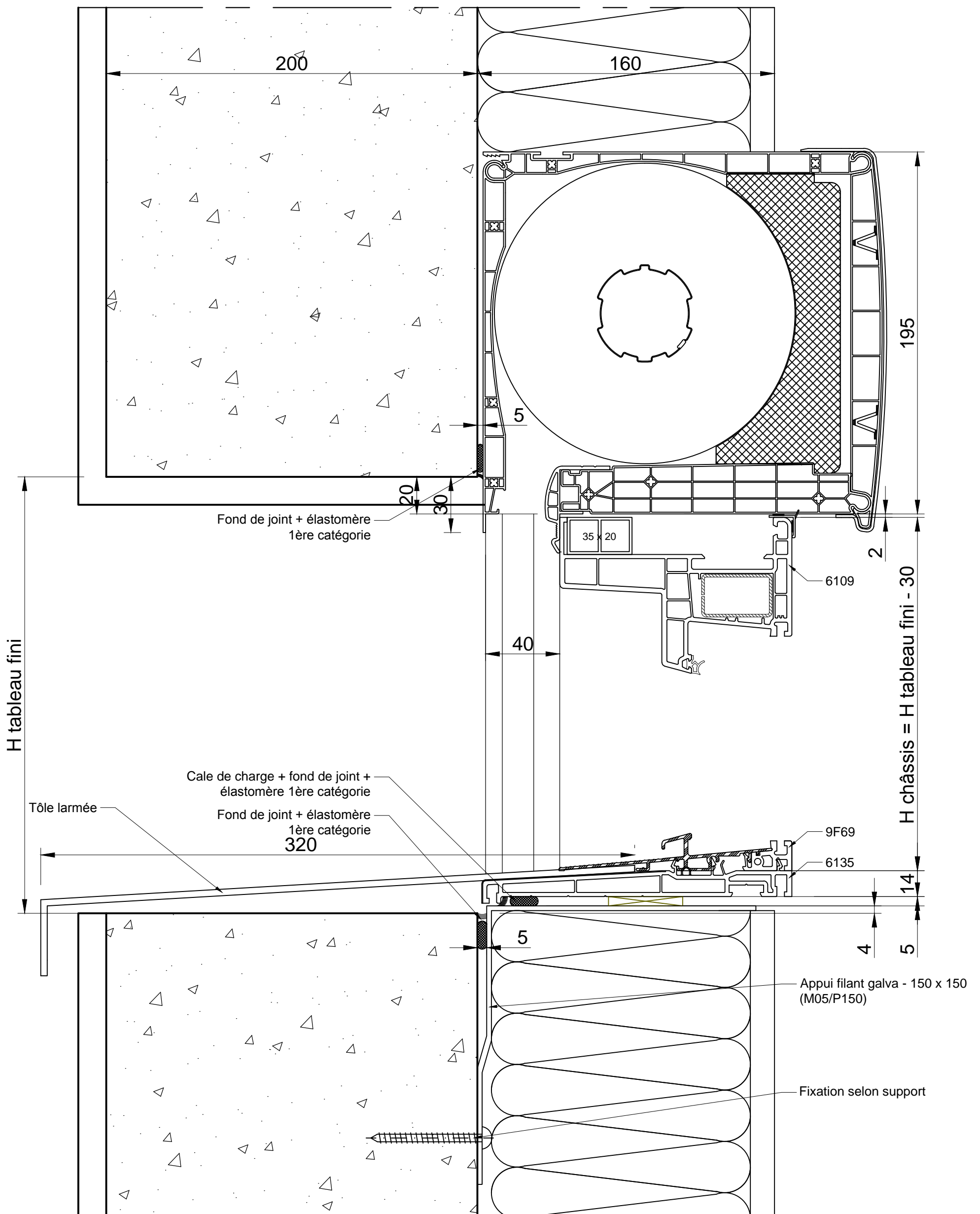

CATA TECH	Dessiné par E. TAVARES	Approuvé par N. BUERMANN	Coupe Verticale	Modifié le 26/11/2018	Date 06/11/2018	Echelle 1/2 - A3
 Fabricant de Fenêtres et Portes.			APPLIQUE RATTRAPAGE ISO 160			
			MISE EN OEUVRE			Edition B

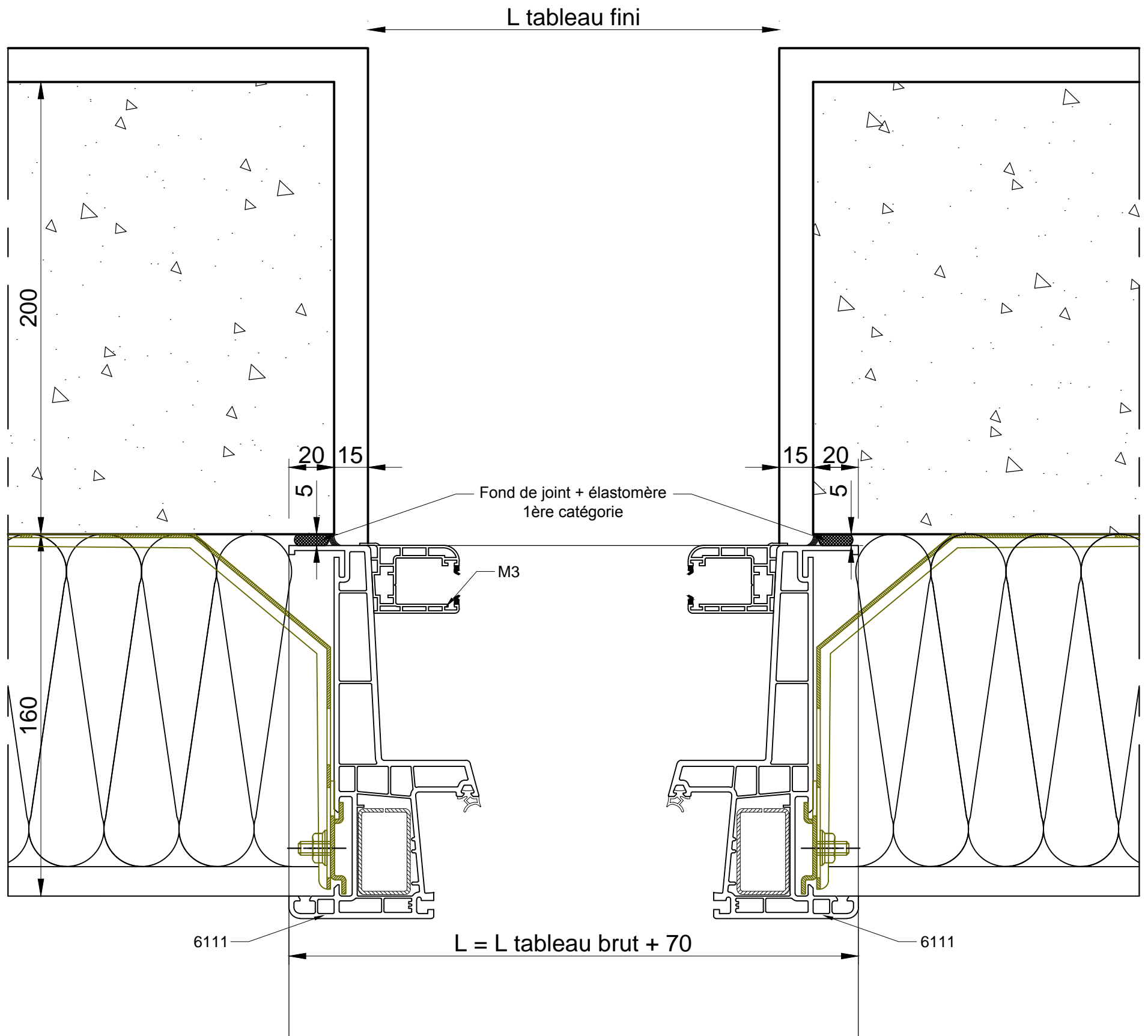

CATA TECH	Dessiné par E. TAVARES	Approuvé par N. BUERMANN	Coupe Verticale	Modifié le 26/11/2018	Date 06/11/2018	Echelle 1/2 - A3
 Fabricant de Fenêtres et Portes.			APPLIQUE RATTRAPAGE ISO 160			
			MISE EN OEUVRE			Edition B

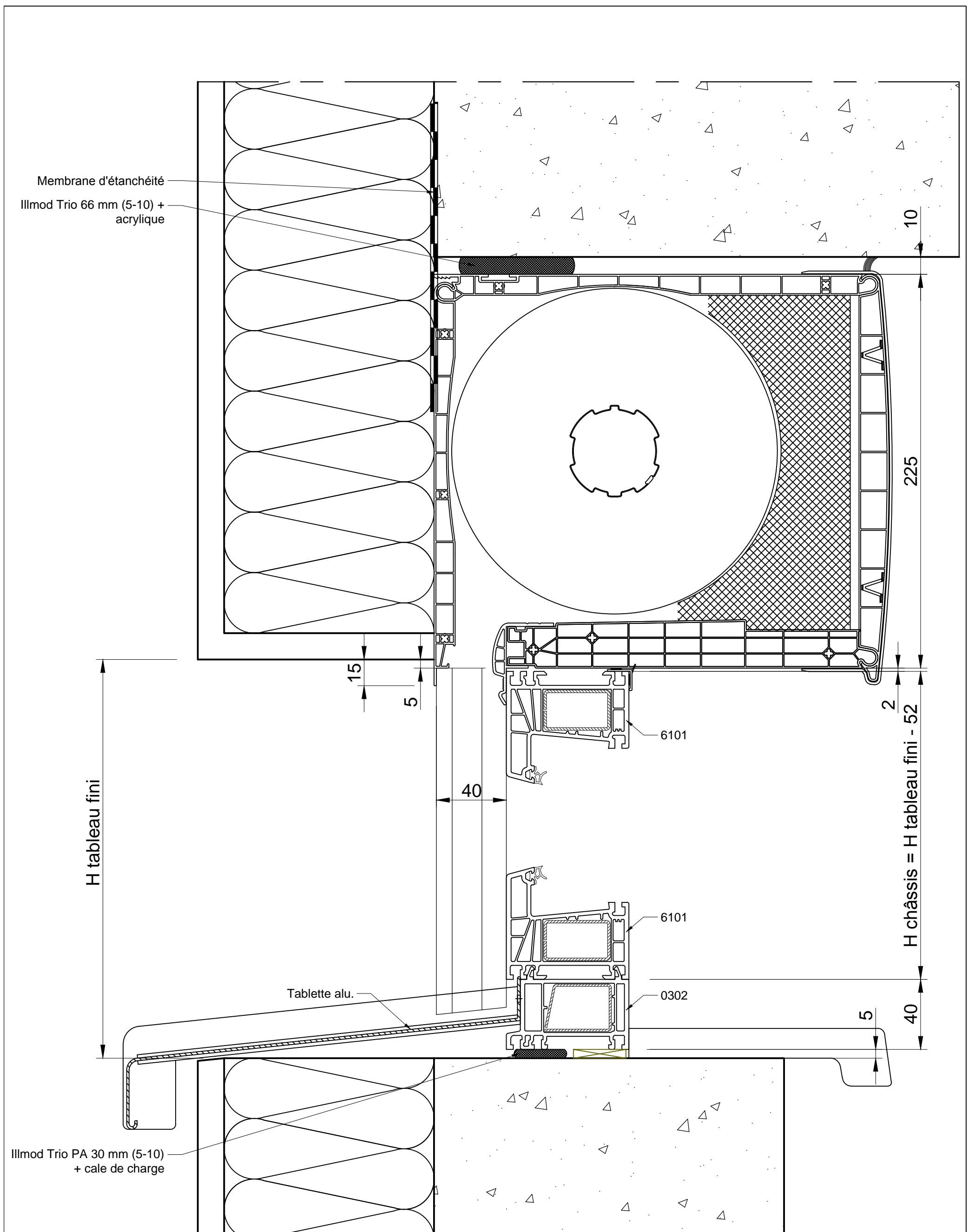

CATA TECH	Dessiné par E. TAVARES	Approuvé par N. BUERMANN	Coupe Verticale	Modifié le 26/11/2018	Date 06/11/2018	Echelle 1/2 - A3
 Fabricant de Fenêtres et Portes.			POSE EN TUNNEL			
			MISE EN OEUVRE	Edition B	Feuille No. PVC 23	

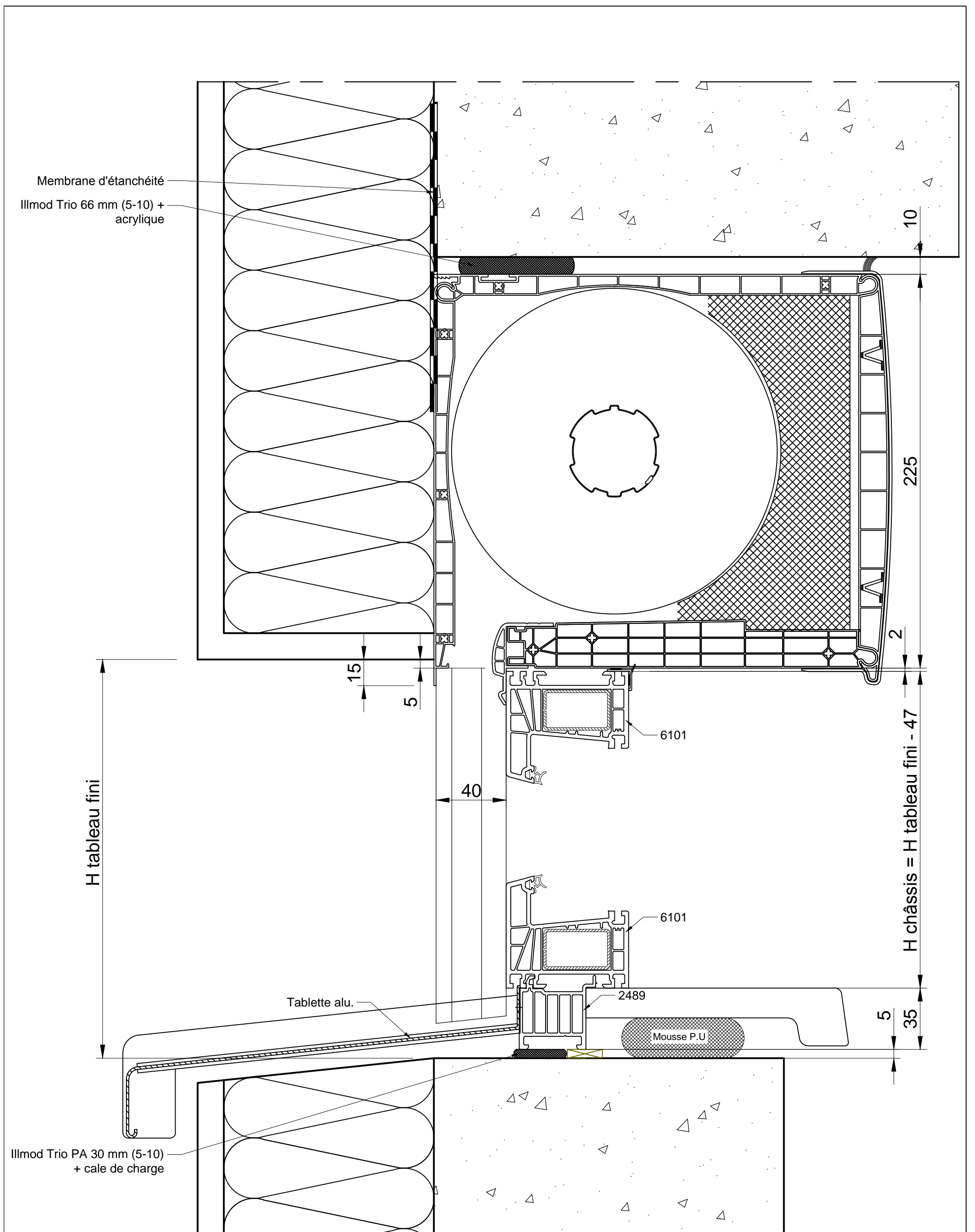

CATA TECH	Dessiné par E. TAVARES	Approuvé par N. BUERMANN	Coupe Verticale	Modifié le 26/11/2018	Date 06/11/2018	Echelle 1/2 - A3
 Fabricant de Fenêtres et Portes.			POSE EN TUNNEL			
			MISE EN OEUVRE	Edition B	Feuille No. PVC 24	

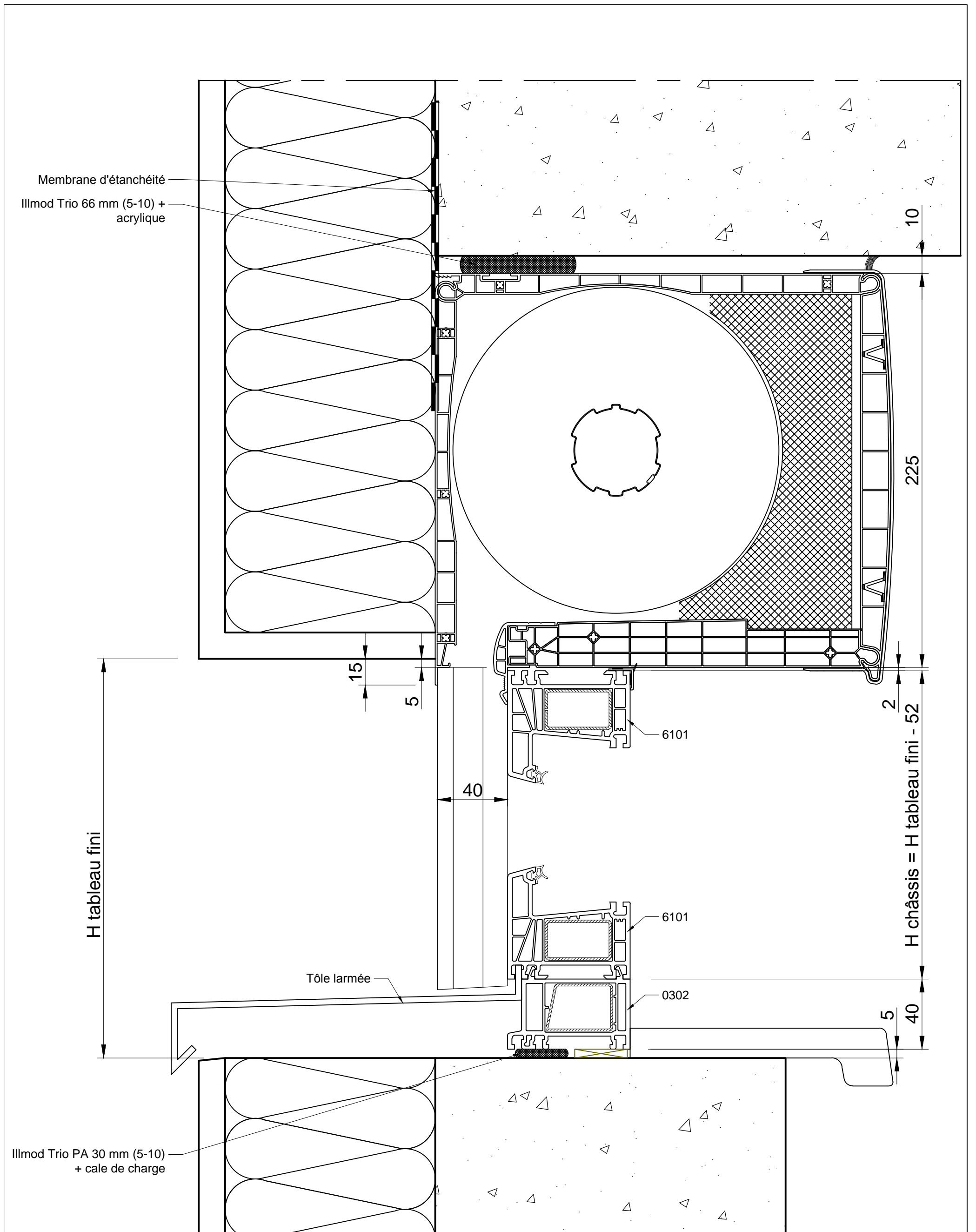

CATA TECH	Dessiné par E. TAVARES	Approuvé par N. BUERMANN	Coupe Verticale	Modifié le 26/11/2018	Date 06/11/2018	Echelle 1/2 - A3
 Fabricant de Fenêtres et Portes.			POSE EN TUNNEL			
			MISE EN OEUVRE	Edition B	Feuille No. PVC 25	

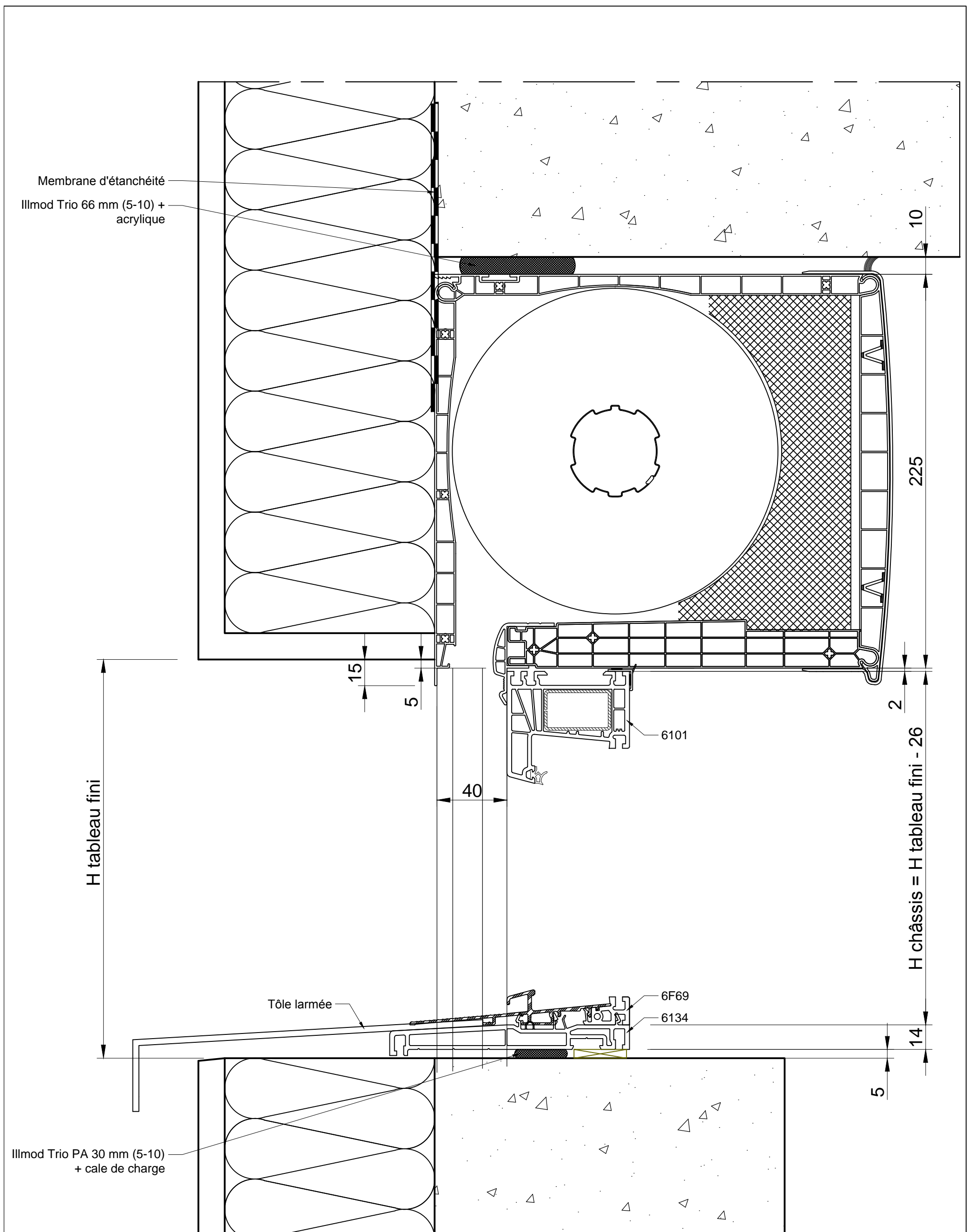

CATA TECH	Dessiné par E. TAVARES	Approuvé par N. BUERMANN	Coupe Verticale	Modifié le 26/11/2018	Date 06/11/2018	Echelle 1/2 - A3
 Fabricant de Fenêtres et Portes.			POSE EN TUNNEL			
			MISE EN OEUVRE	Edition B	Feuille No. PVC 26	

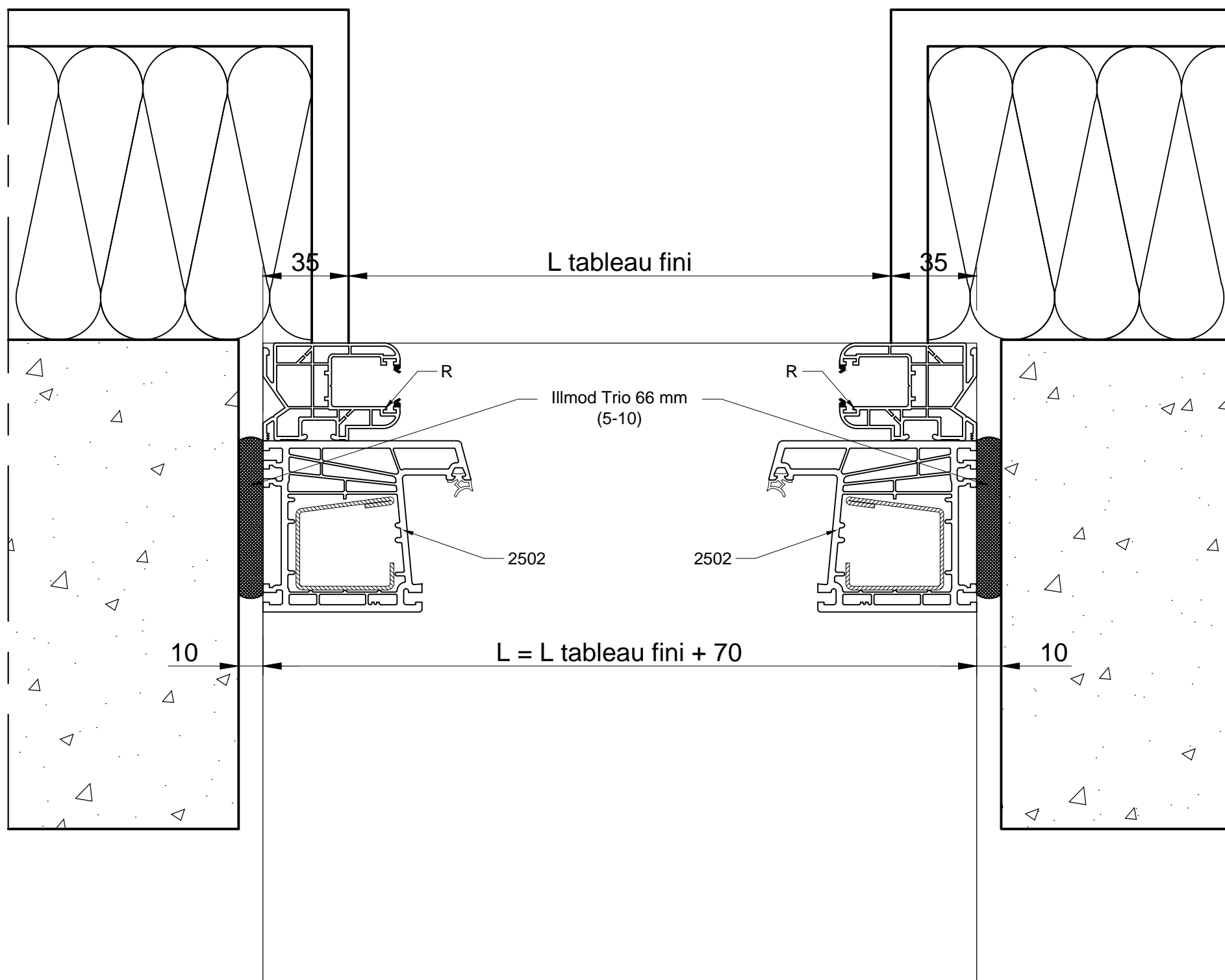

CATA TECH	Dessiné par E. TAVARES	Approuvé par N. BUERMANN	Coupe Verticale	Modifié le 26/11/2018	Date 06/11/2018	Echelle 1/2 - A3
 Fabricant de Fenêtres et Portes.			POSE EN TUNNEL			
			MISE EN OEUVRE	Edition B	Feuille No. PVC 27	

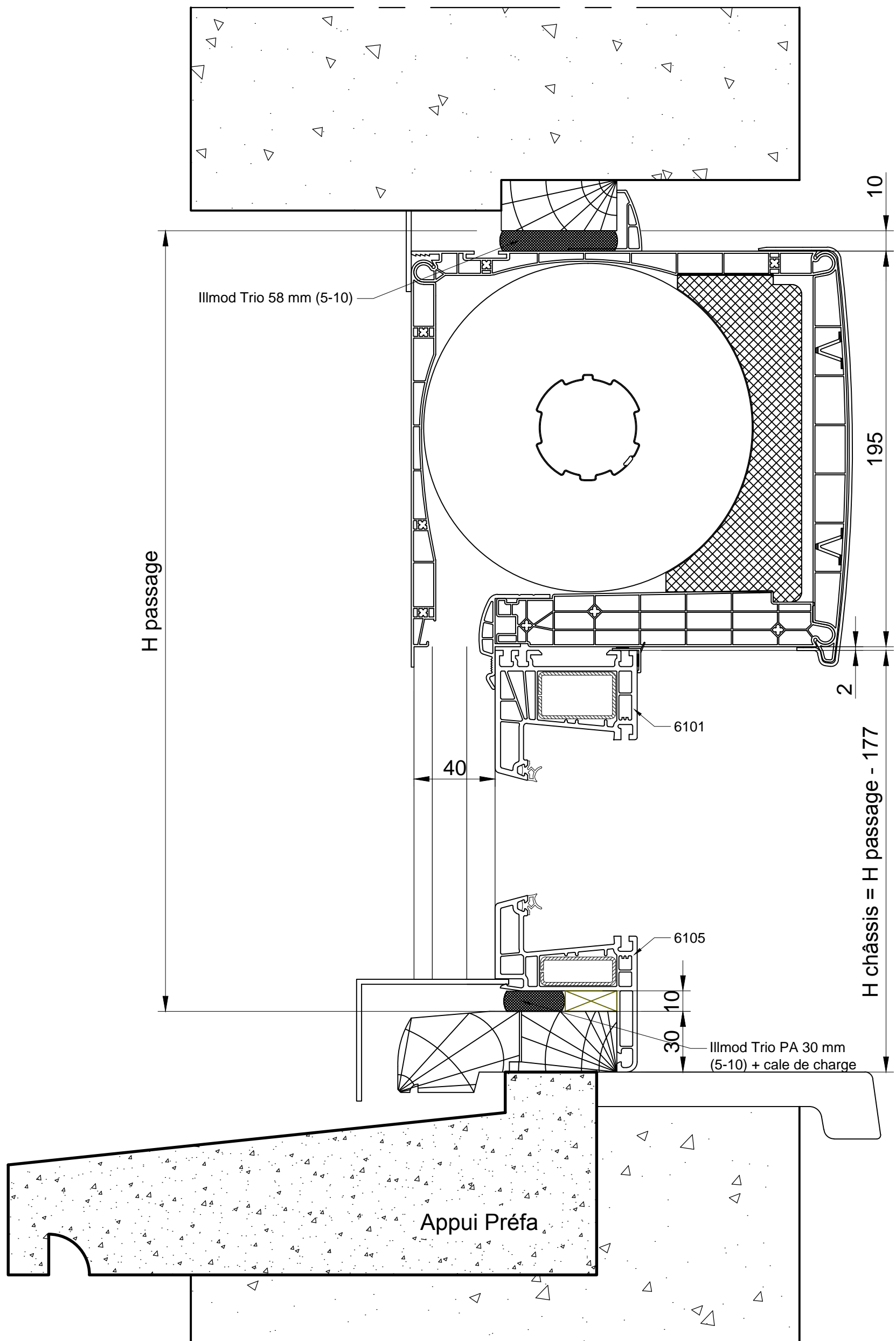

CATA TECH	Dessiné par E. TAVARES	Approuvé par N. BUERMANN	Coupe Verticale	Modifié le 26/11/2018	Date 06/11/2018	Echelle 1/2 - A3
 Fabricant de Fenêtres et Portes.			RENOVATION			
			MISE EN OEUVRE			Edition B

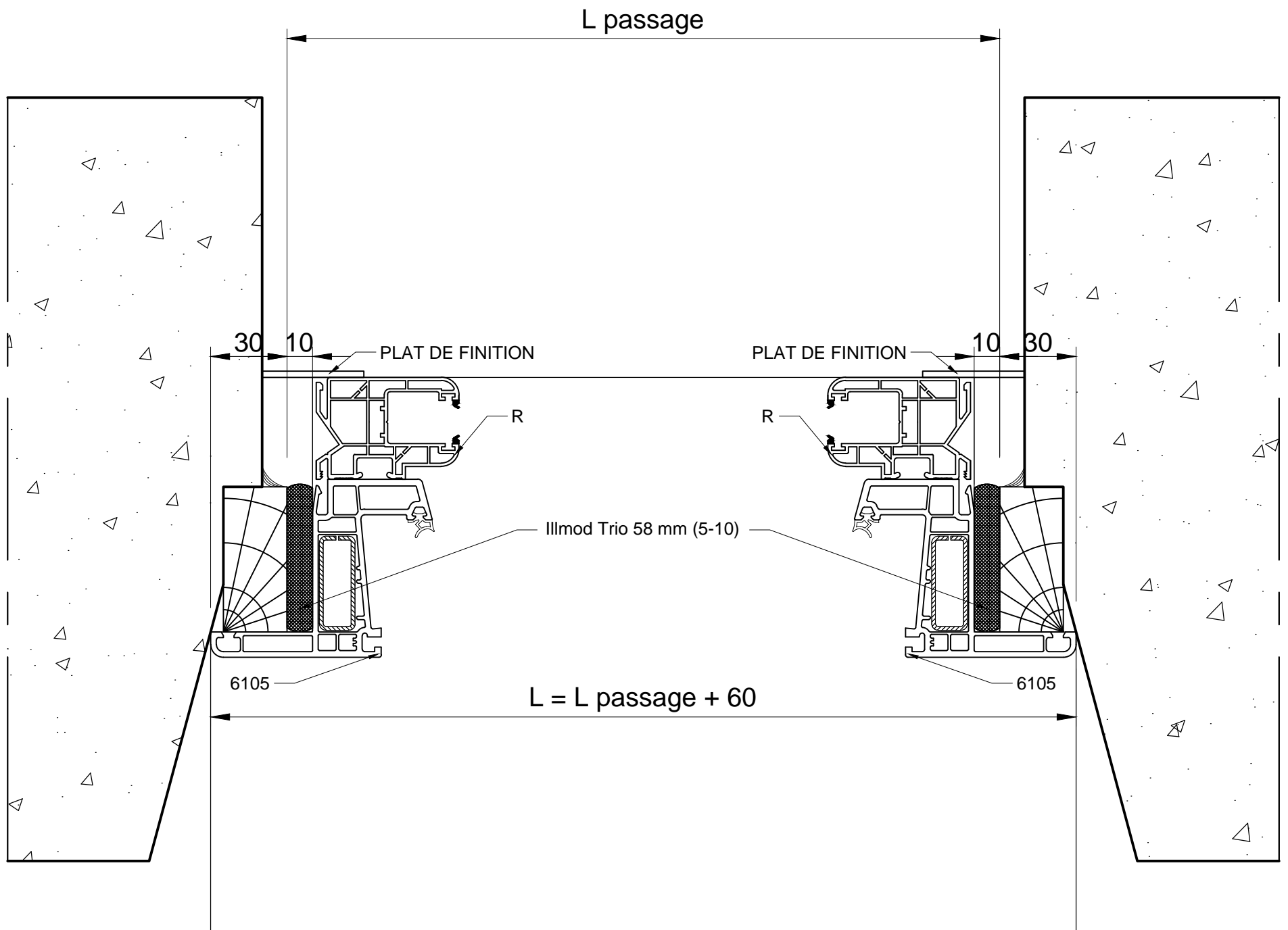

CATA TECH	Dessiné par E. TAVARES	Approuvé par N. BUERMANN	Coupe Verticale	Modifié le 26/11/2018	Date 06/11/2018	Echelle 1/2 - A3
 Fabricant de Fenêtres et Portes.			RENOVATION			
			MISE EN OEUVRE			Edition B

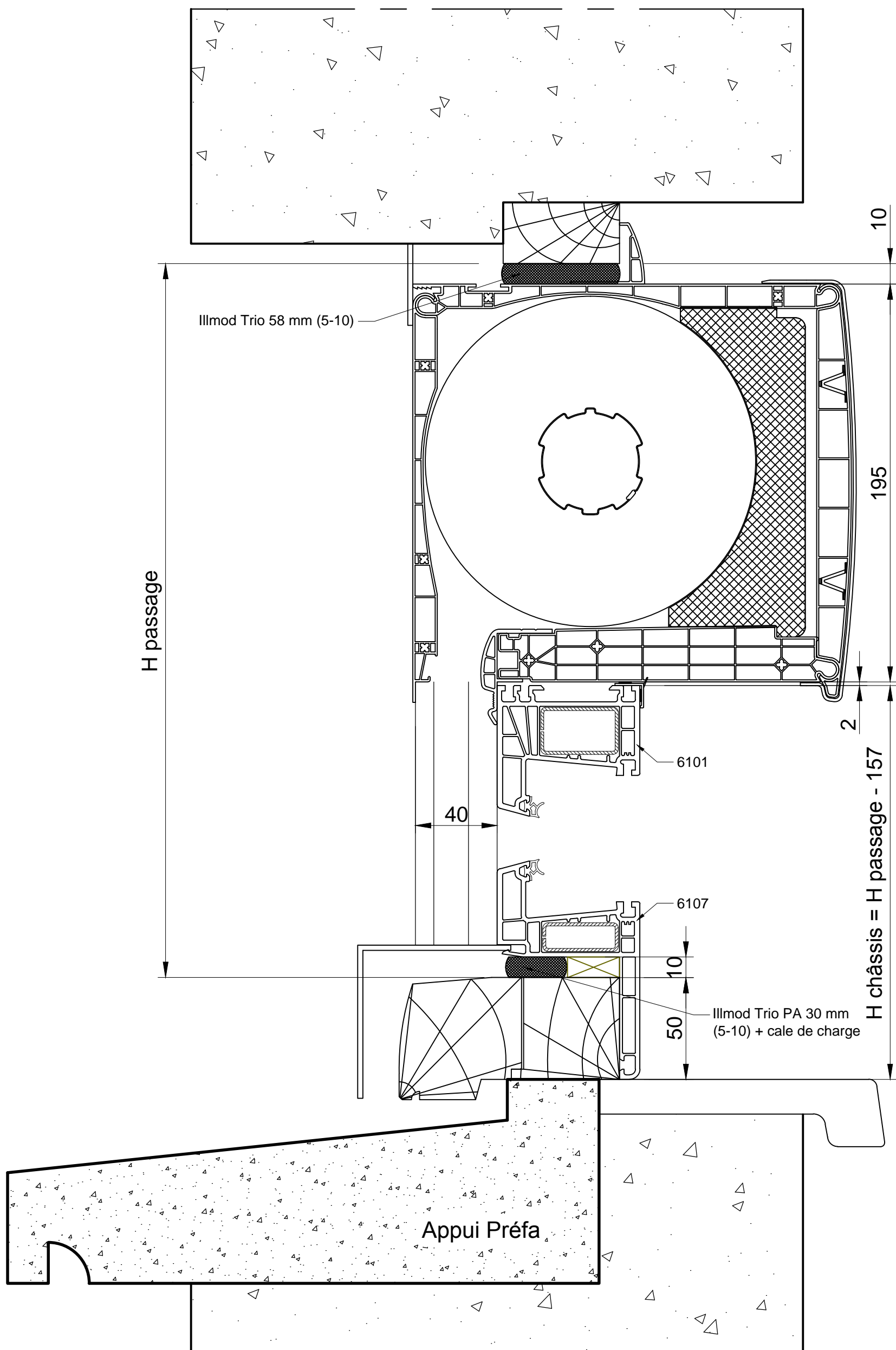

CATA TECH	Dessiné par E. TAVARES	Approuvé par N. BUERMANN	Coupe Verticale	Modifié le 26/11/2018	Date 06/11/2018	Echelle 1/2 - A3
 Fabricant de Fenêtres et Portes.			RENOVATION			
			MISE EN OEUVRE	Edition B	Feuille No. PVC 30	

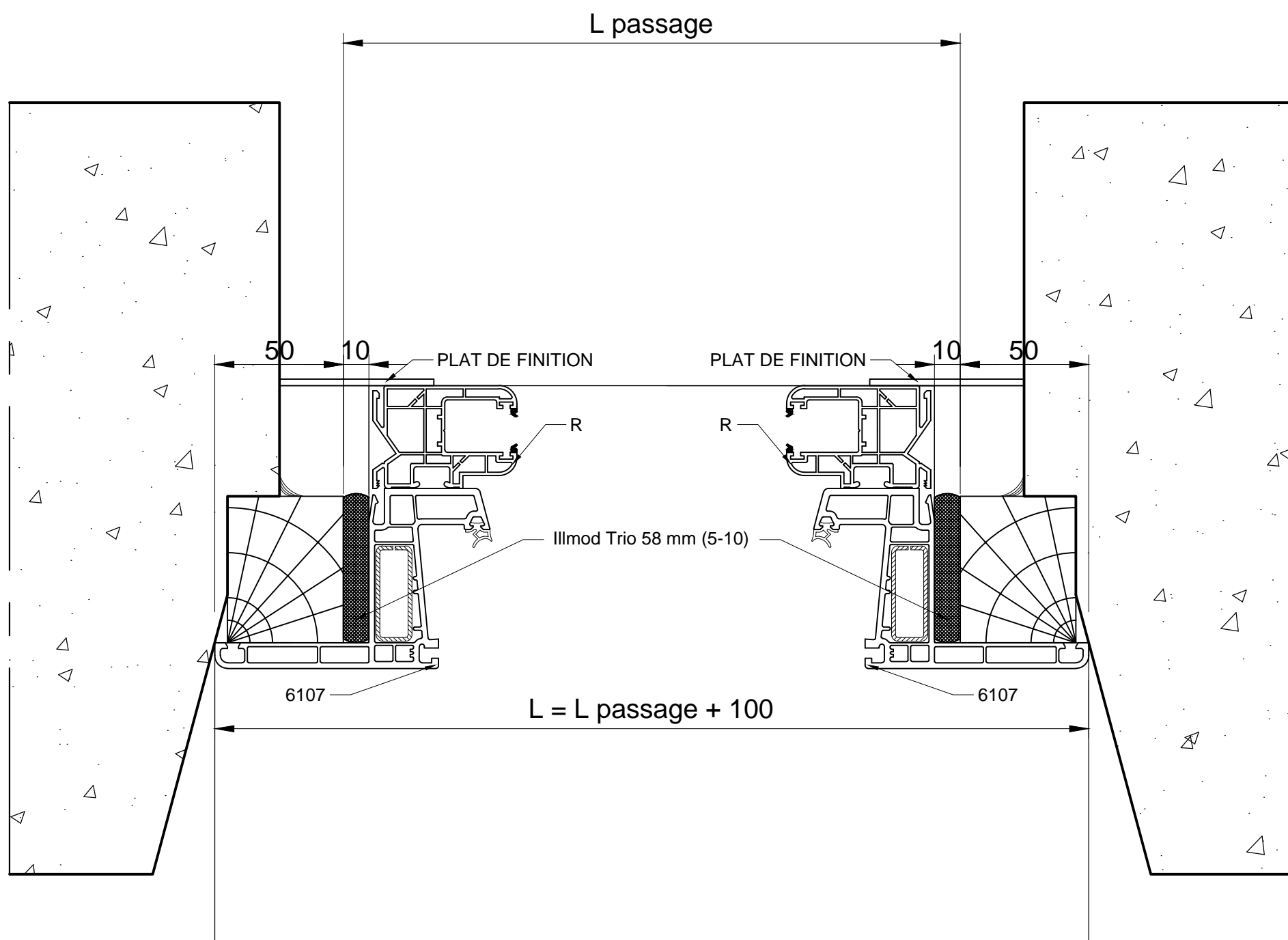

CATA TECH	Dessiné par E. TAVARES	Approuvé par N. BUERMANN	Coupe Verticale	Modifié le 26/11/2018	Date 06/11/2018	Echelle 1/2 - A3
 Fabricant de Fenêtres et Portes.			RENOVATION			
			MISE EN OEUVRE			Edition B

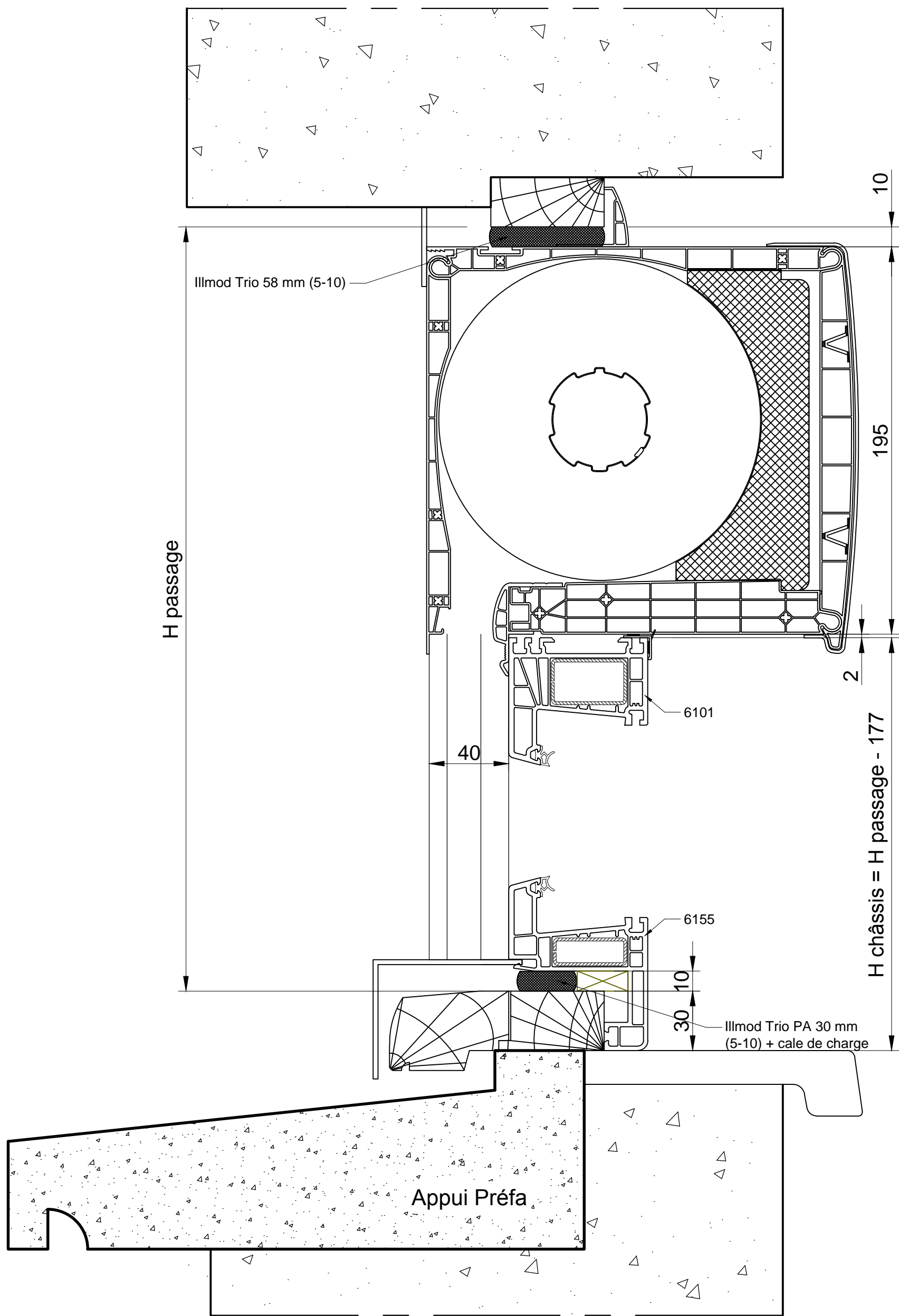

CATA TECH	Dessiné par E. TAVARES	Approuvé par N. BUERMANN	Coupe Verticale	Modifié le 26/11/2018	Date 06/11/2018	Echelle 1/2 - A3
 Fabricant de Fenêtres et Portes.			RENOVATION			
			MISE EN OEUVRE	Edition B	Feuille No. PVC 32	

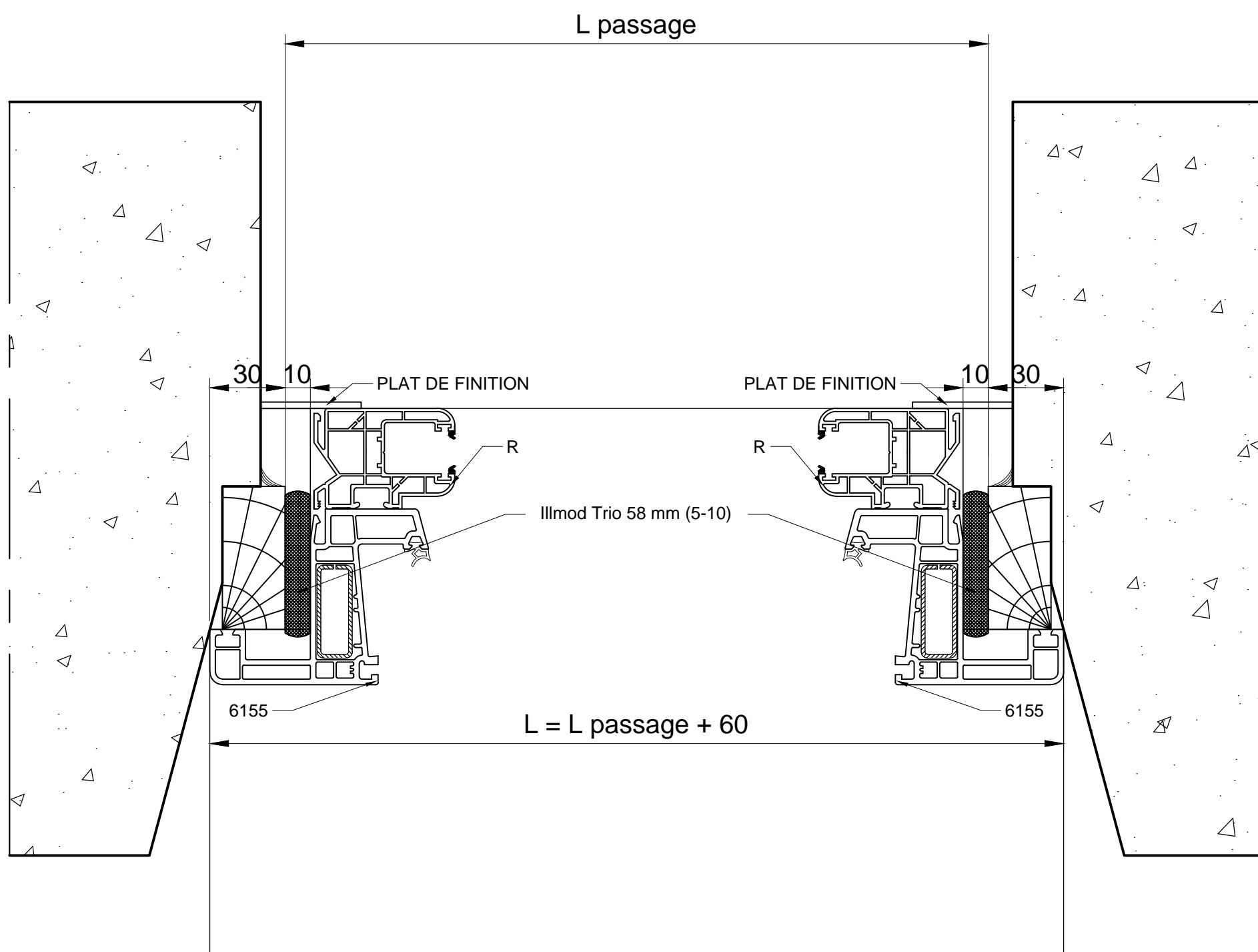

CATA TECH	Dessiné par E. TAVARES	Approuvé par N. BUERMANN	Coupe Verticale	Modifié le 26/11/2018	Date 06/11/2018	Echelle 1/2 - A3
 Fabricant de Fenêtres et Portes.			RENOVATION			
			MISE EN OEUVRE			Edition B

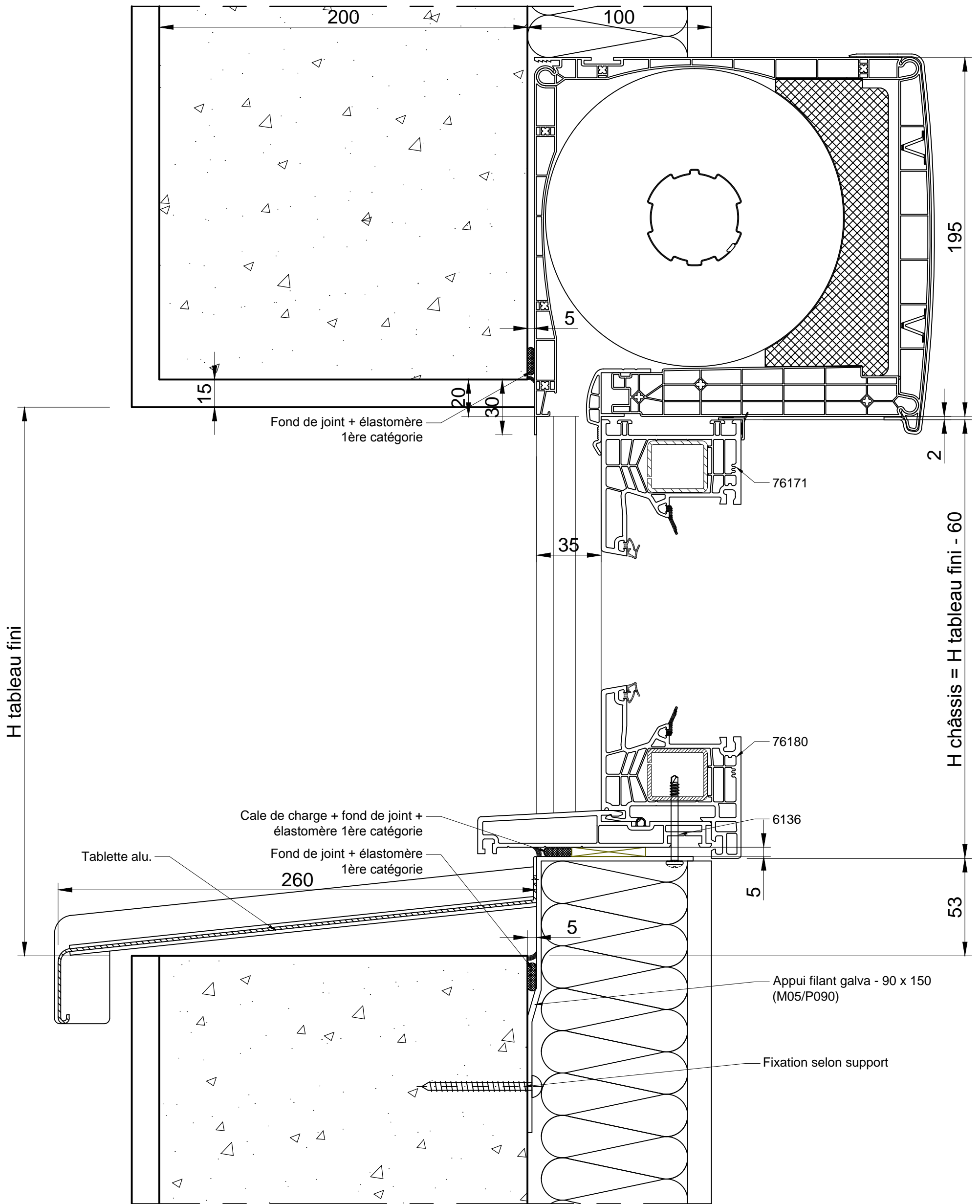

CATA TECH	Dessiné par E. TAVARES	Approuvé par N. BUERMANN	Coupe Verticale	Modifié le 26/11/2018	Date 06/11/2018	Echelle 1/2 - A3
 <p>hilzinger Fabricant de Fenêtres et Portes.</p>			APPLIQUE RATTRAPAGE ISO 100			
			MISE EN OEUVRE			Edition B

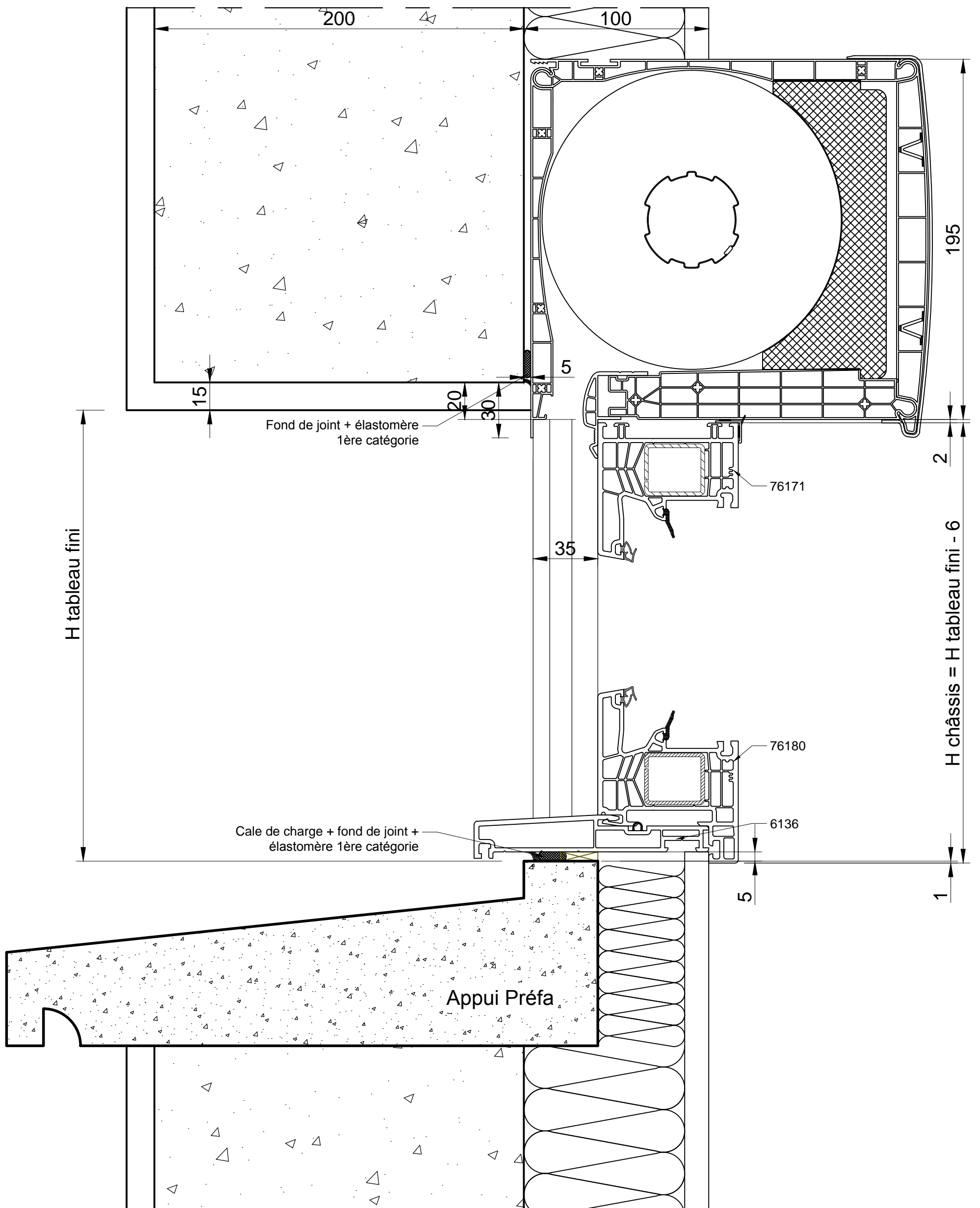

CATA TECH	Dessiné par E. TAVARES	Approuvé par N. BUERMANN	Coupe Verticale	Modifié le 26/11/2018	Date 06/11/2018	Echelle 1/2 - A3
 Fabricant de Fenêtres et Portes.			APPLIQUE RATTRAPAGE ISO 100			
			MISE EN OEUVRE			Edition B

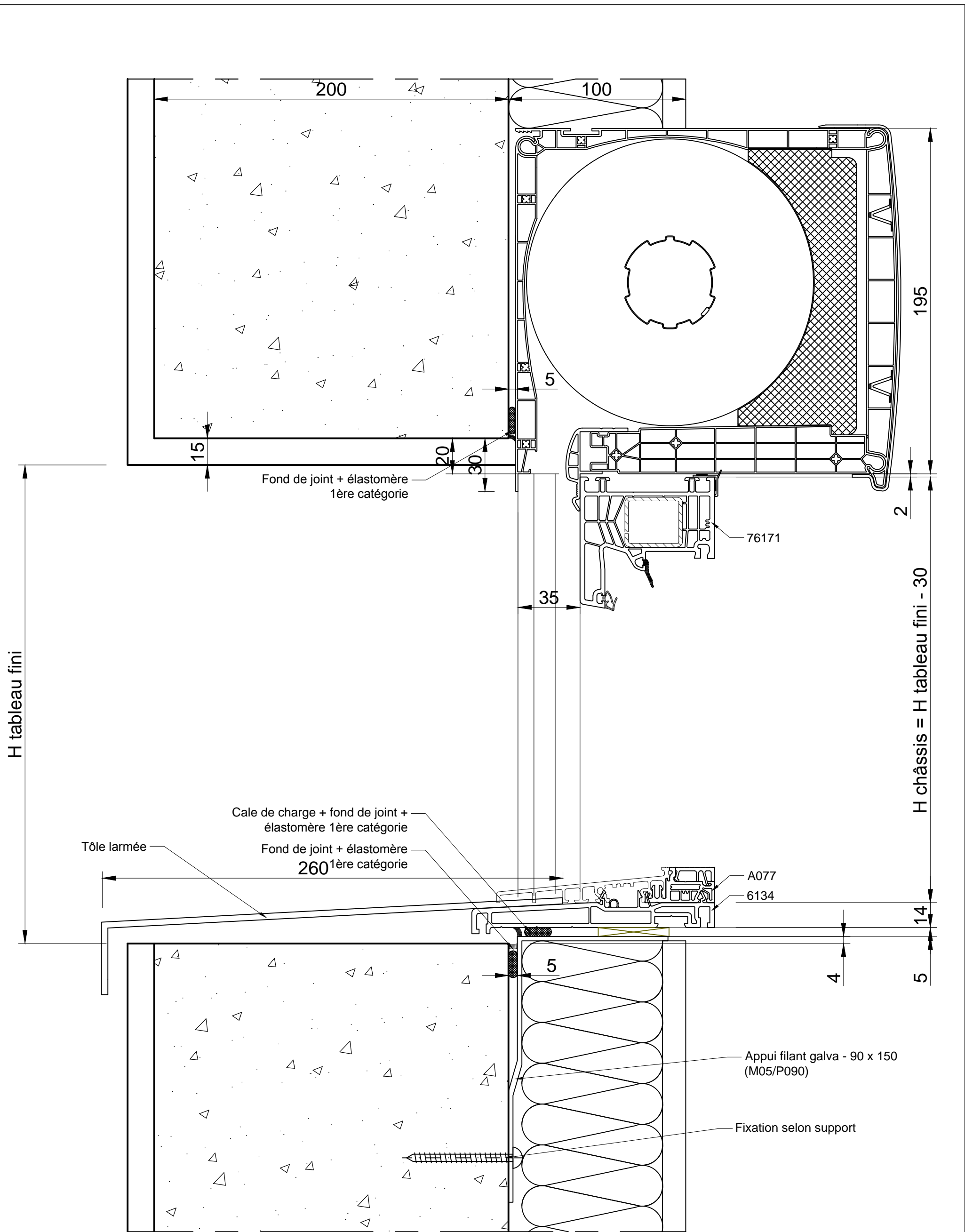

CATA TECH	Dessiné par E. TAVARES	Approuvé par N. BUERMANN	Coupe Verticale	Modifié le 26/11/2018	Date 06/11/2018	Echelle 1/2 - A3
 Fabricant de Fenêtres et Portes.			APPLIQUE RATRAPAGE ISO 100			
			MISE EN OEUVRE			Edition B

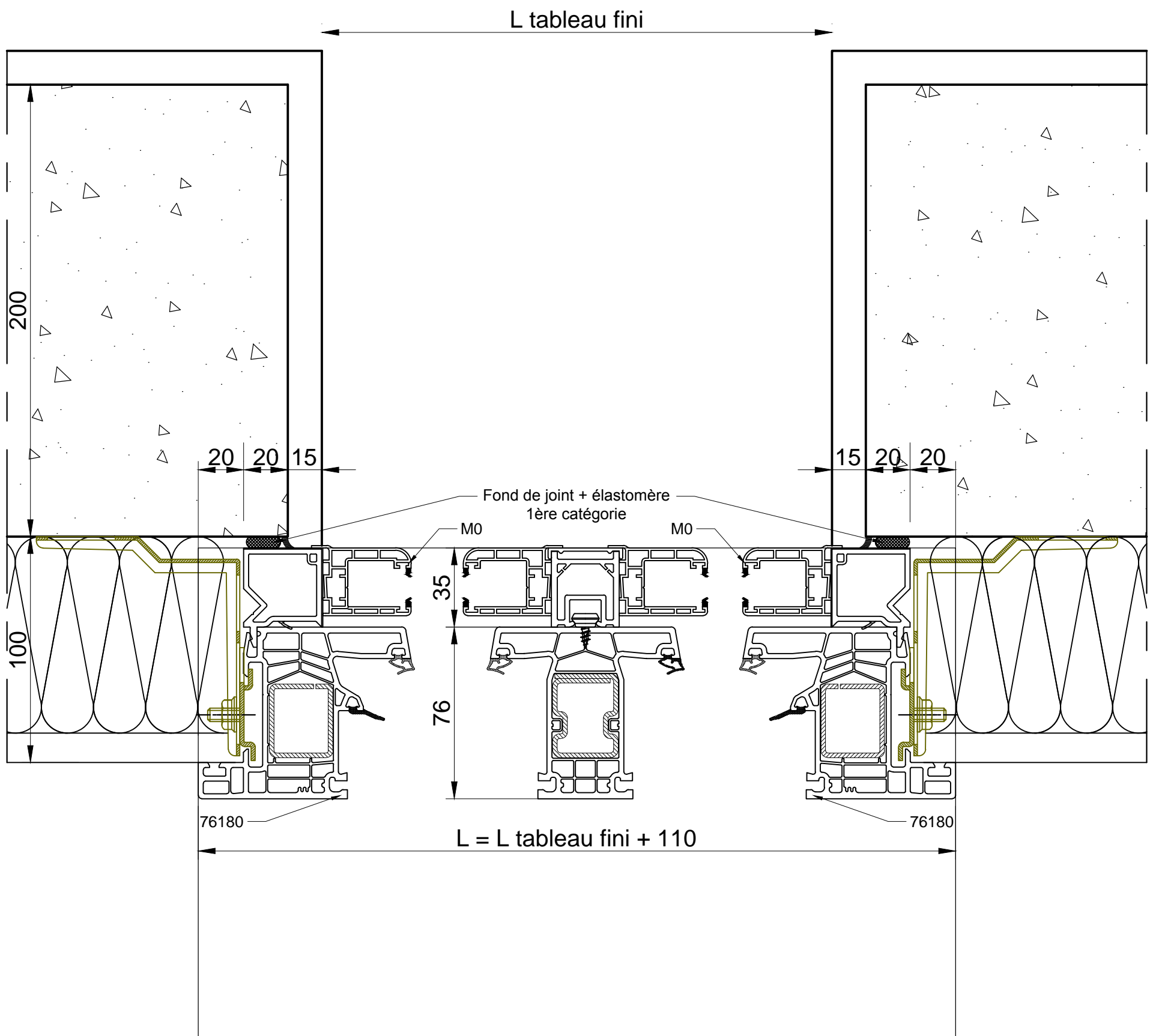

CATA TECH	Dessiné par E. TAVARES	Approuvé par N. BUERMANN	Coupe Verticale	Modifié le 26/11/2018	Date 06/11/2018	Echelle 1/2 - A3
 <p>hilzinger Fabricant de Fenêtres et Portes.</p>			APPLIQUE RATTRAPAGE ISO 100			
			MISE EN OEUVRE			Edition B

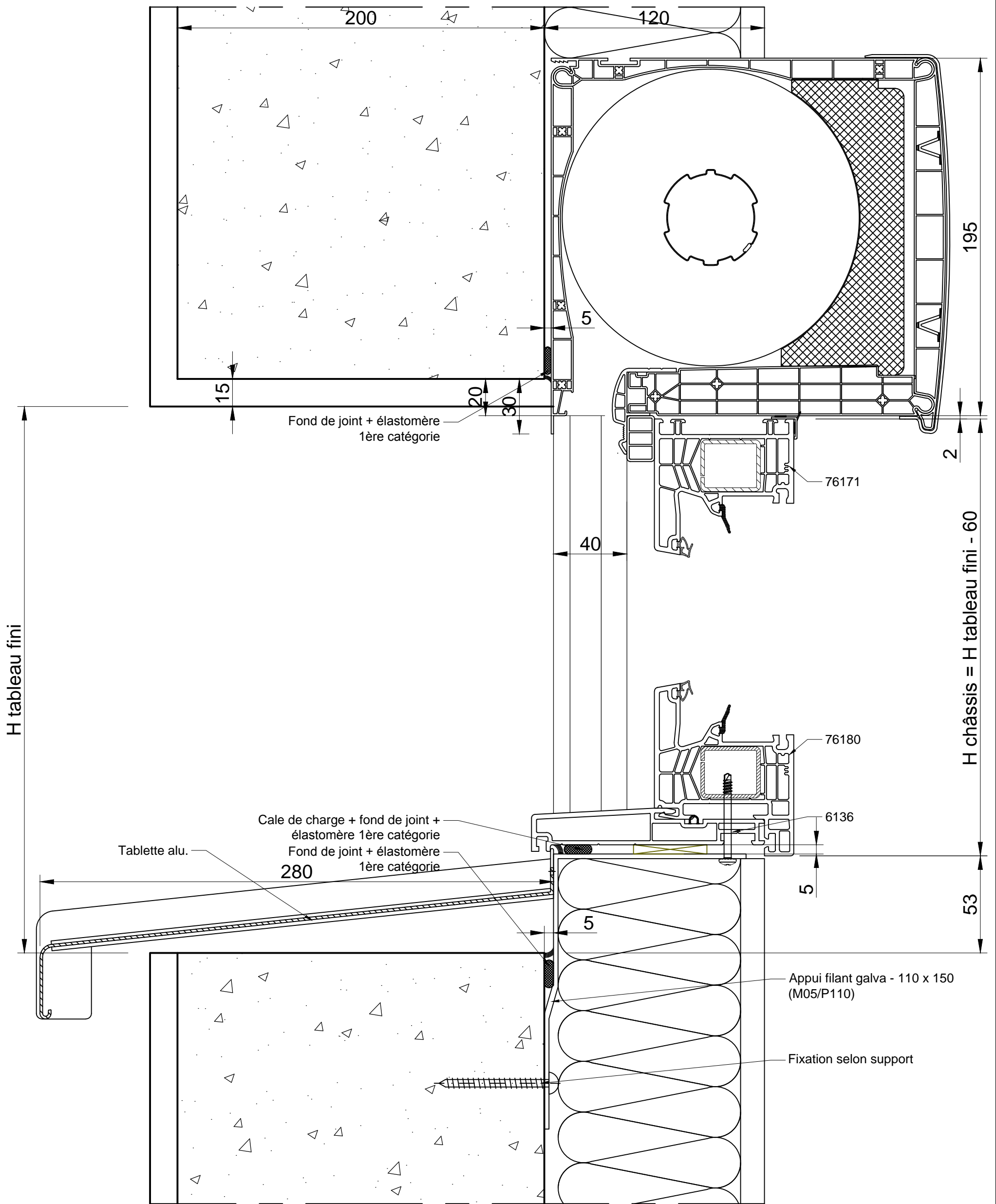

CATA TECH	Dessiné par E. TAVARES	Approuvé par N. BUERMANN	Coupe Verticale	Modifié le 26/11/2018	Date 06/11/2018	Echelle 1/2 - A3
 Fabricant de Fenêtres et Portes.			APPLIQUE RATTRAPAGE ISO 120			
			MISE EN OEUVRE			Edition B

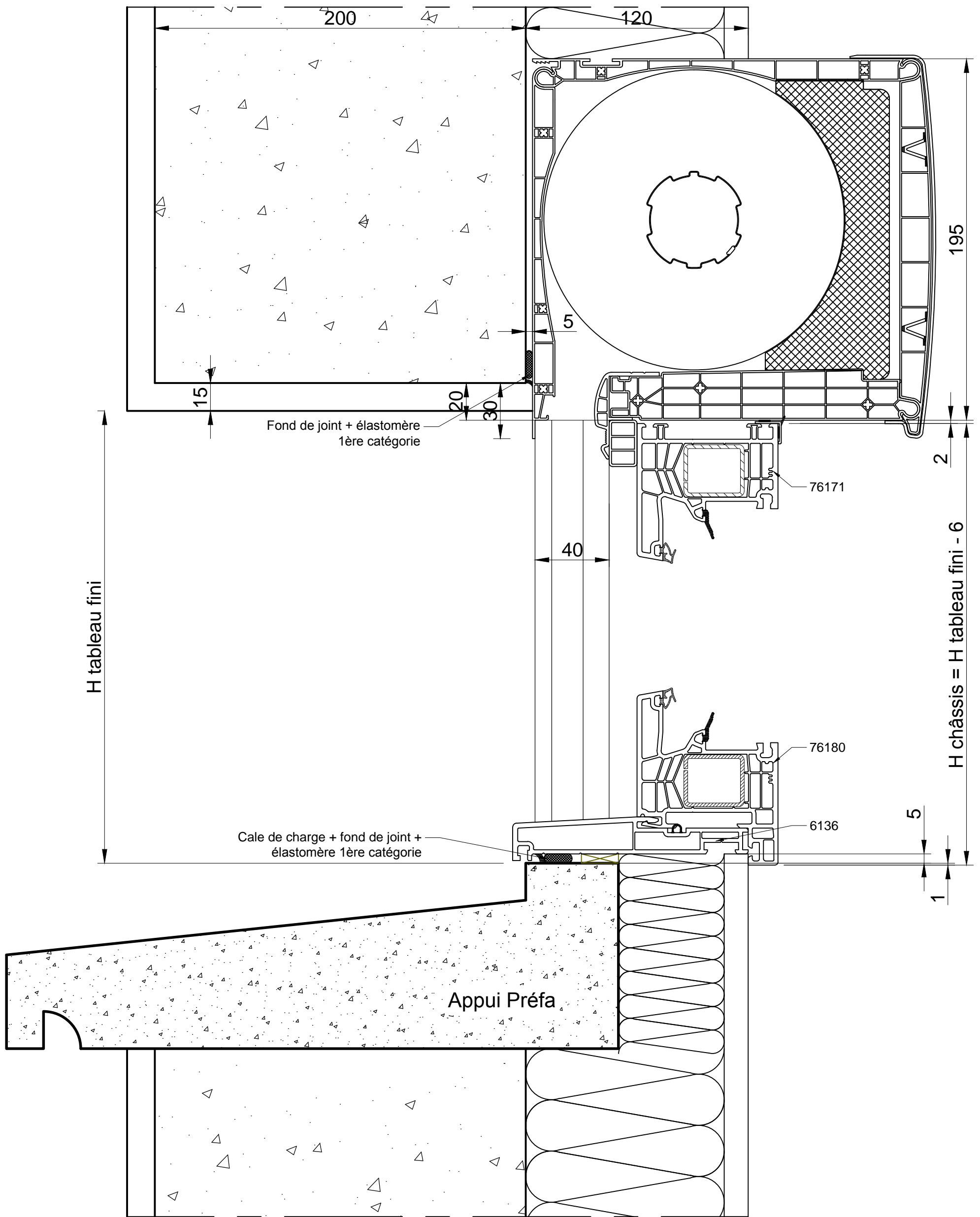

CATA TECH	Dessiné par E. TAVARES	Approuvé par N. BUERMANN	Coupe Verticale	Modifié le 26/11/2018	Date 06/11/2018	Echelle 1/2 - A3
 Fabricant de Fenêtres et Portes.			APPLIQUE RATTRAPAGE ISO 120			
			MISE EN OEUVRE			Edition B

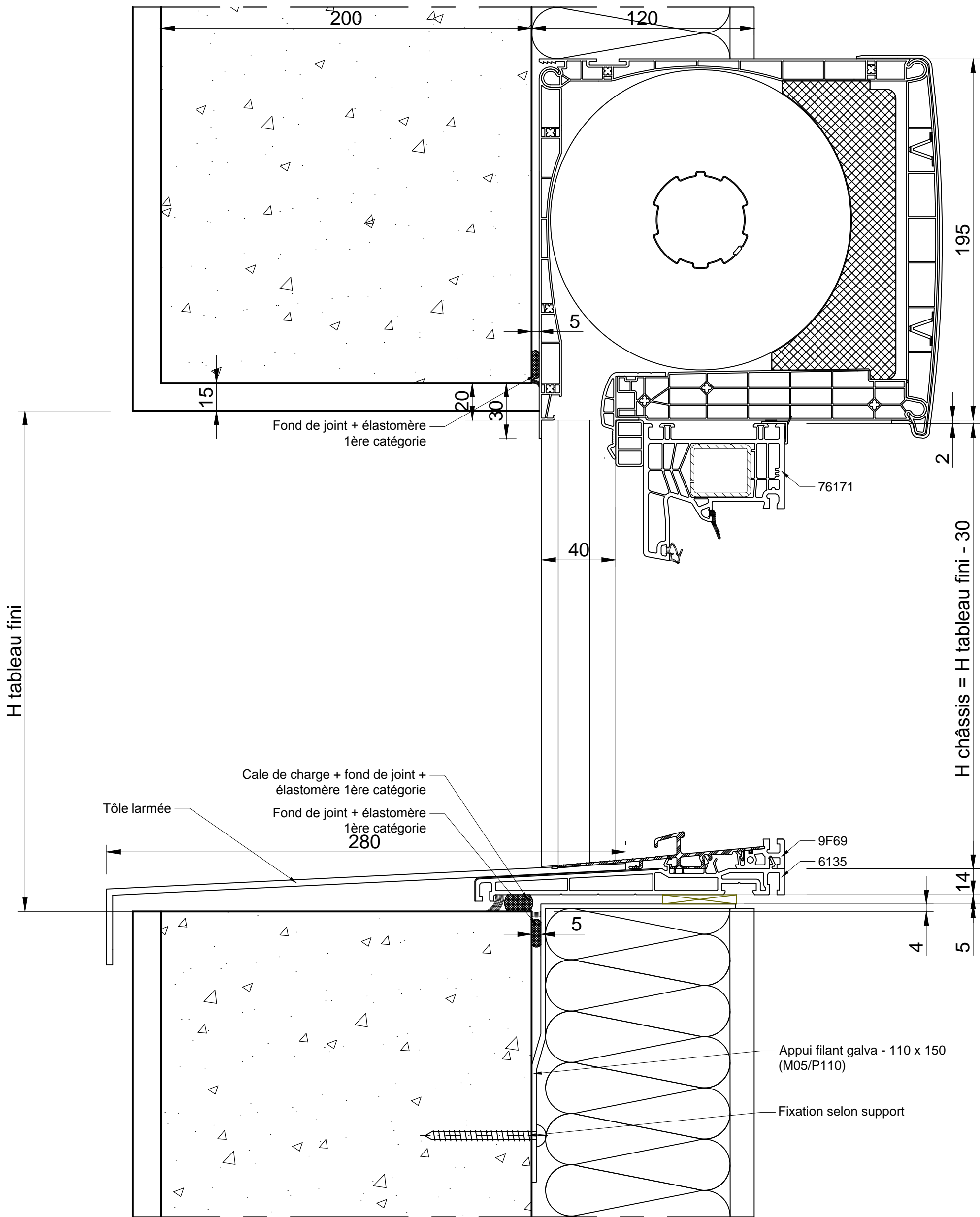

CATA TECH	Dessiné par E. TAVARES	Approuvé par N. BUERMANN	Coupe Verticale	Modifié le 26/11/2018	Date 06/11/2018	Echelle 1/2 - A3
 <p>hilzinger Fabricant de Fenêtres et Portes.</p>			APPLIQUE RATTRAPAGE ISO 120			
			MISE EN OEUVRE			Edition B

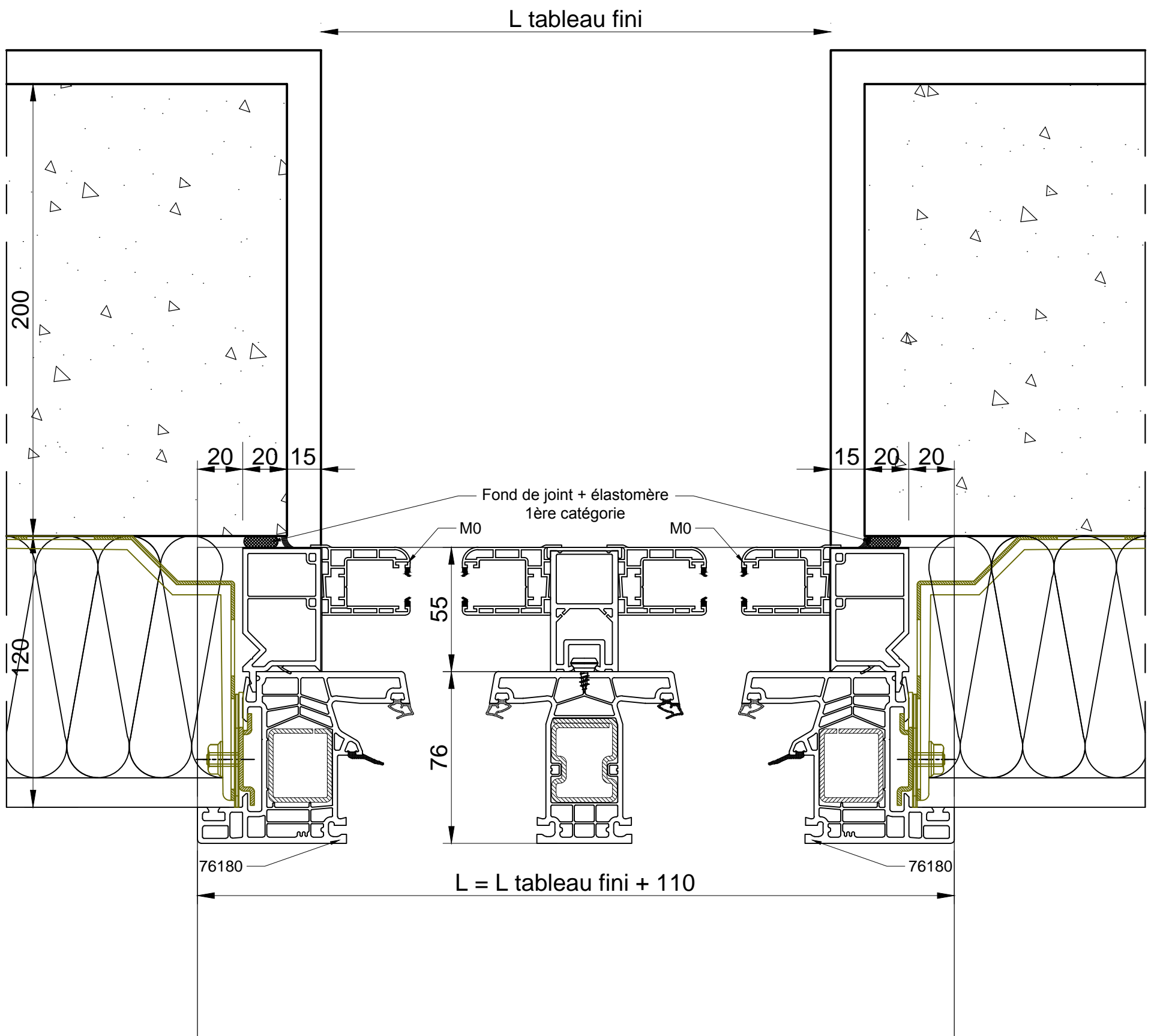

CATA TECH	Dessiné par E. TAVARES	Approuvé par N. BUERMANN	Coupe Verticale	Modifié le 26/11/2018	Date 06/11/2018	Echelle 1/2 - A3
 Fabricant de Fenêtres et Portes.			APPLIQUE RATTRAPAGE ISO 120			
			MISE EN OEUVRE			Edition B

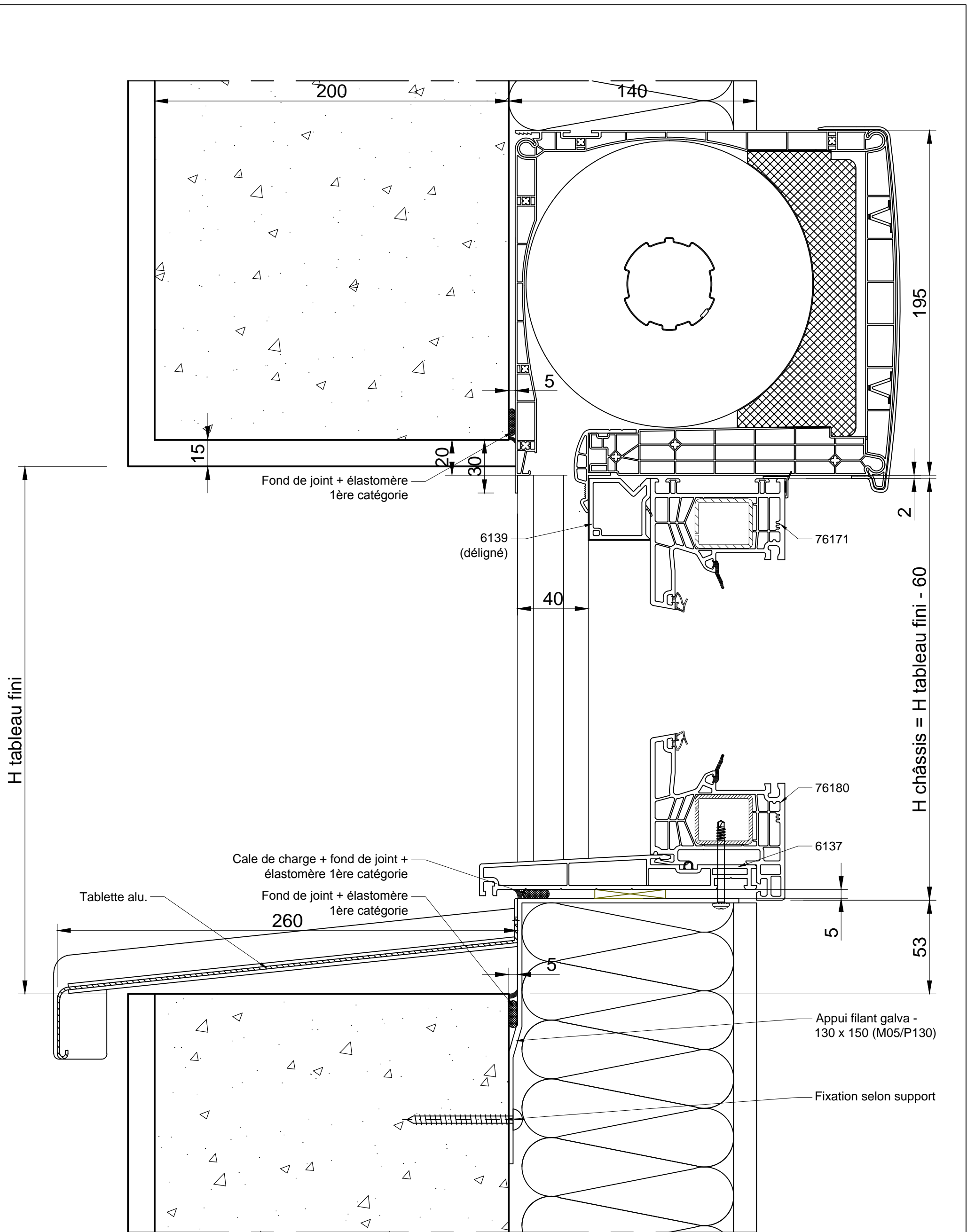

CATA TECH	Dessiné par E. TAVARES	Approuvé par N. BUERMANN	Coupe Verticale	Modifié le 26/11/2018	Date 06/11/2018	Echelle 1/2 - A3
 Fabricant de Fenêtres et Portes.			APPLIQUE RATTRAPAGE ISO 140			
			MISE EN OEUVRE			Edition B

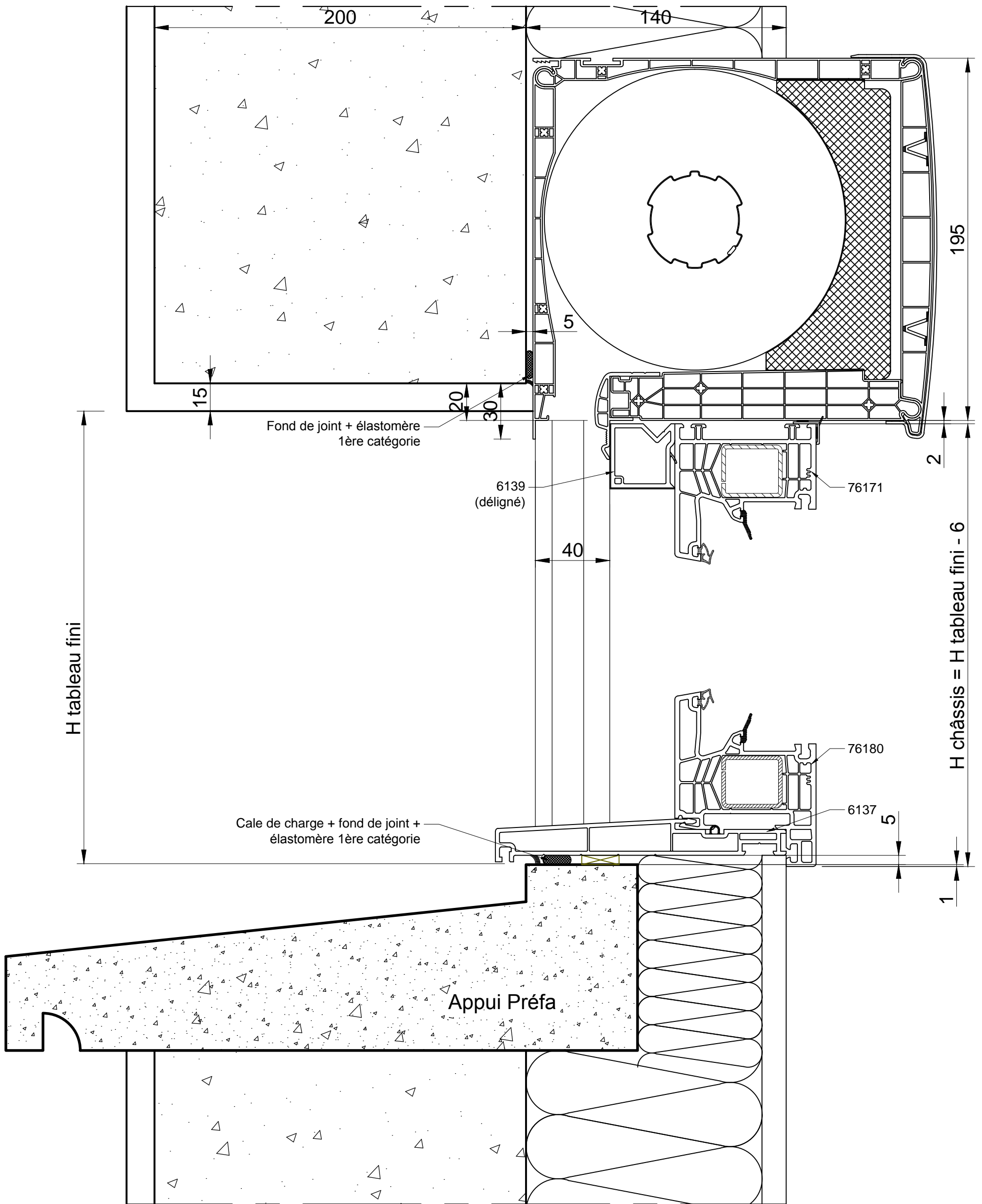



H tableau fini

H châssis = H tableau fini - 6

Appui Préfa

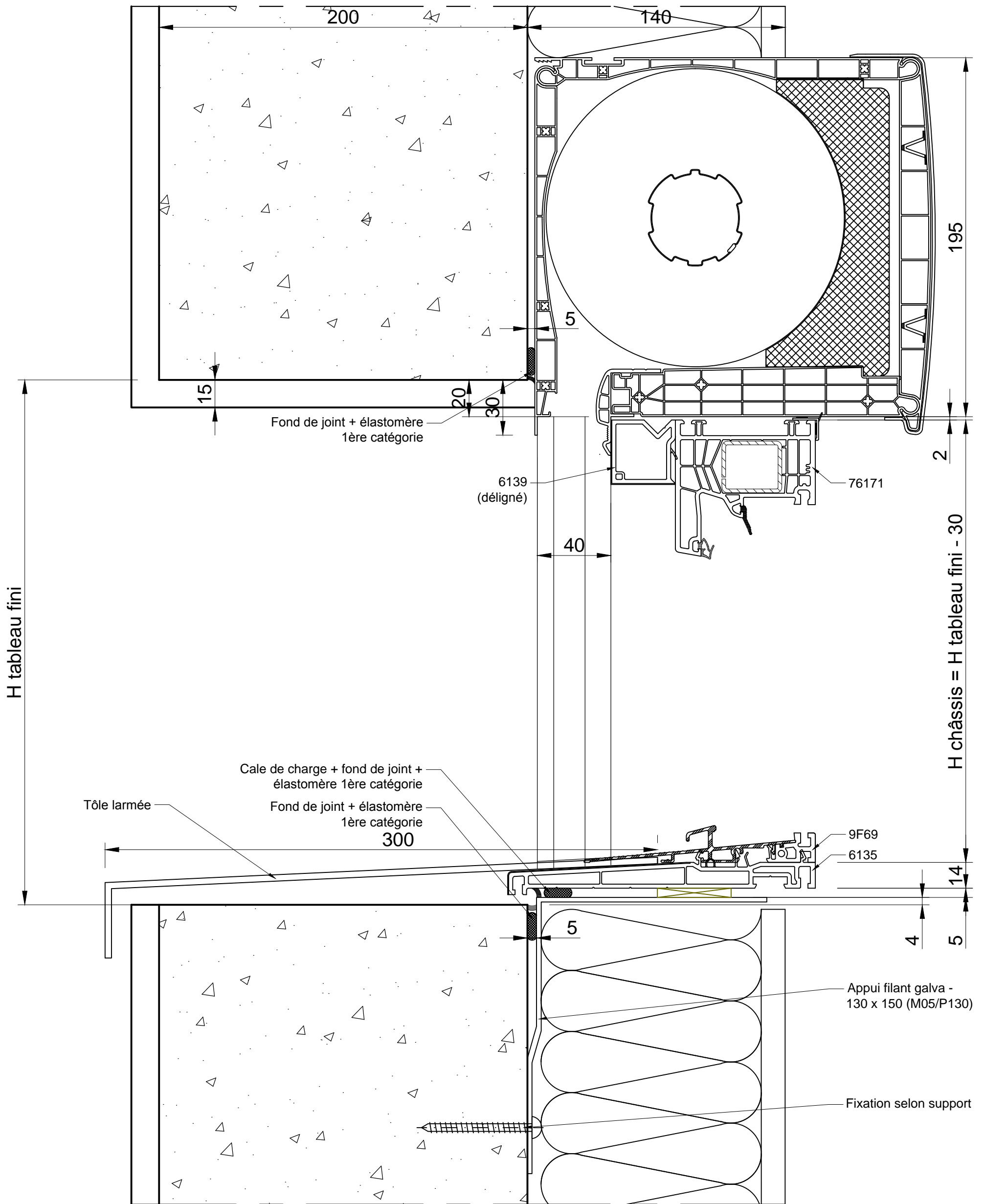
CATA TECH	Dessiné par E. TAVARES	Approuvé par N. BUERMANN	Coupe Verticale	Modifié le 26/11/2018	Date 06/11/2018	Echelle 1/2 - A3
 Fabricant de Fenêtres et Portes.			APPLIQUE RATRAPAGE ISO 140			
			MISE EN OEUVRE			Edition B



CATA TECH	Dessiné par E. TAVARES	Approuvé par N. BUERMANN	Coupe Verticale	Modifié le 26/11/2018	Date 06/11/2018	Echelle 1/2 - A3
 <p>hilzinger Fabricant de Fenêtres et Portes.</p>			APPLIQUE RATRAPAGE ISO 140			
			MISE EN OEUVRE			Edition B

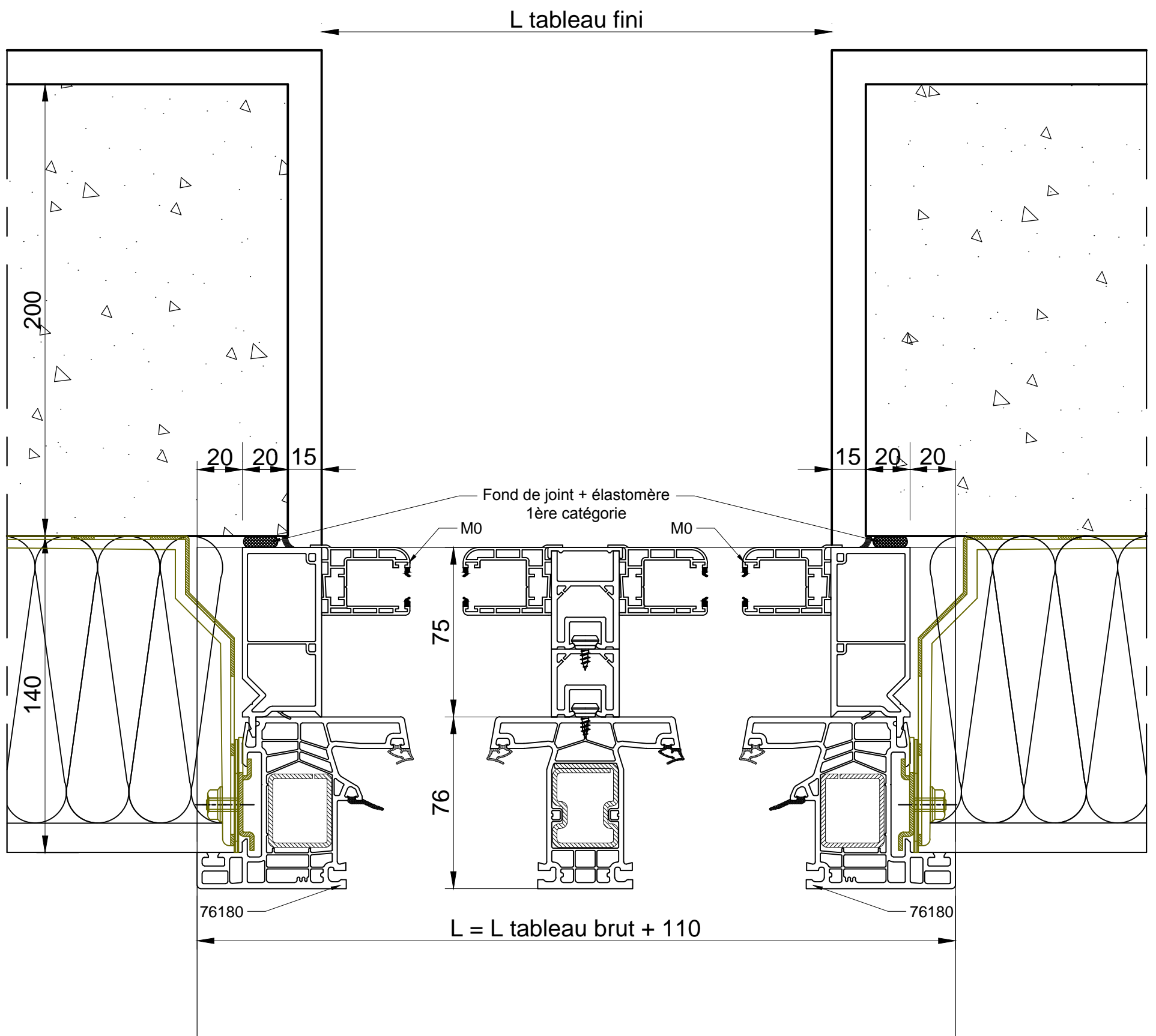

CATA TECH	Dessiné par E. TAVARES	Approuvé par N. BUERMANN	Coupe Verticale	Modifié le 26/11/2018	Date 06/11/2018	Echelle 1/2 - A3
 Fabricant de Fenêtres et Portes.			APPLIQUE RATTRAPAGE ISO 140			
			MISE EN OEUVRE			Edition B

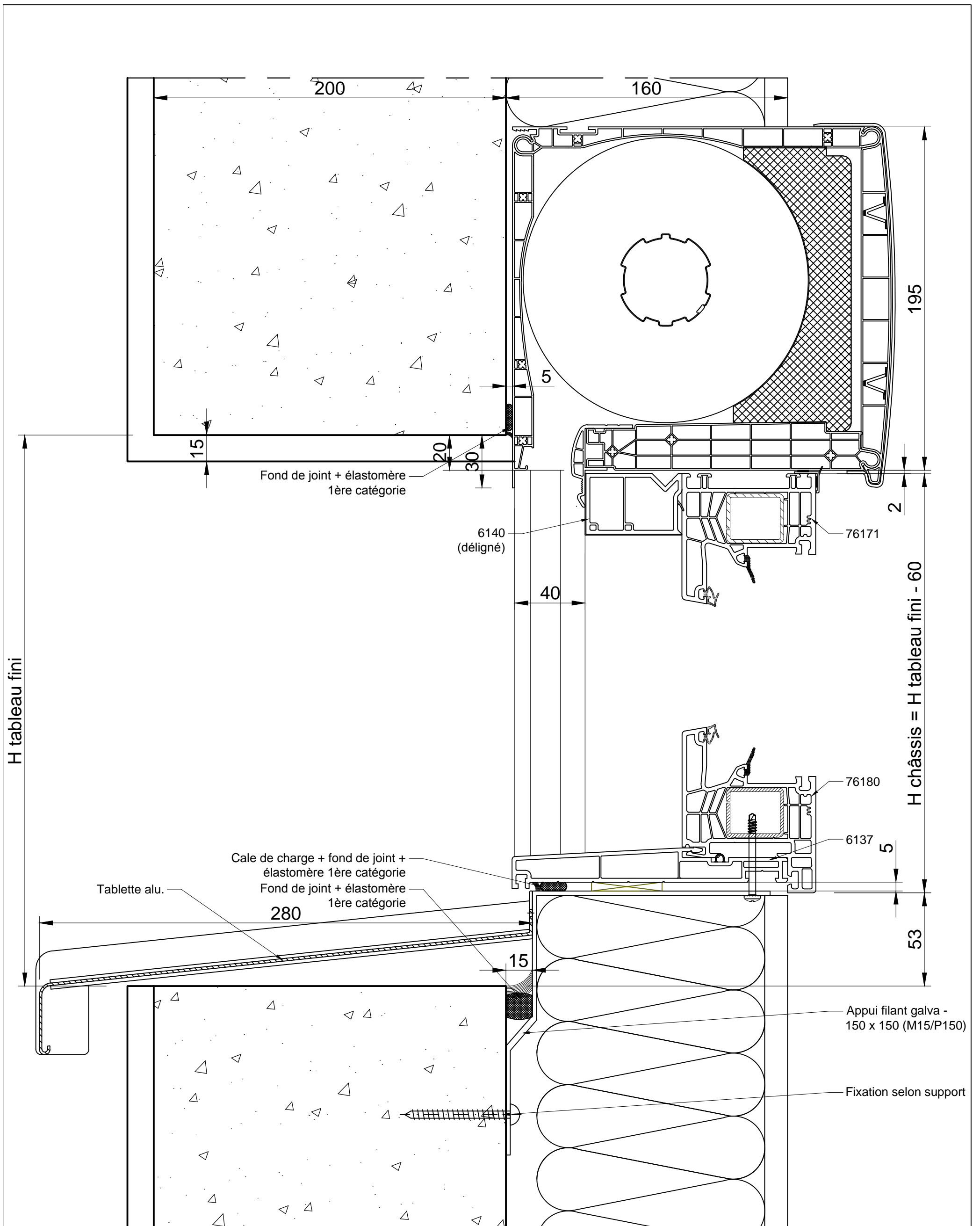

CATA TECH	Dessiné par E. TAVARES	Approuvé par N. BUERMANN	Coupe Verticale	Modifié le 26/11/2018	Date 06/11/2018	Echelle 1/2 - A3
 Fabricant de Fenêtres et Portes.			APPLIQUE RATTRAPAGE ISO 160			
			MISE EN OEUVRE			Edition B

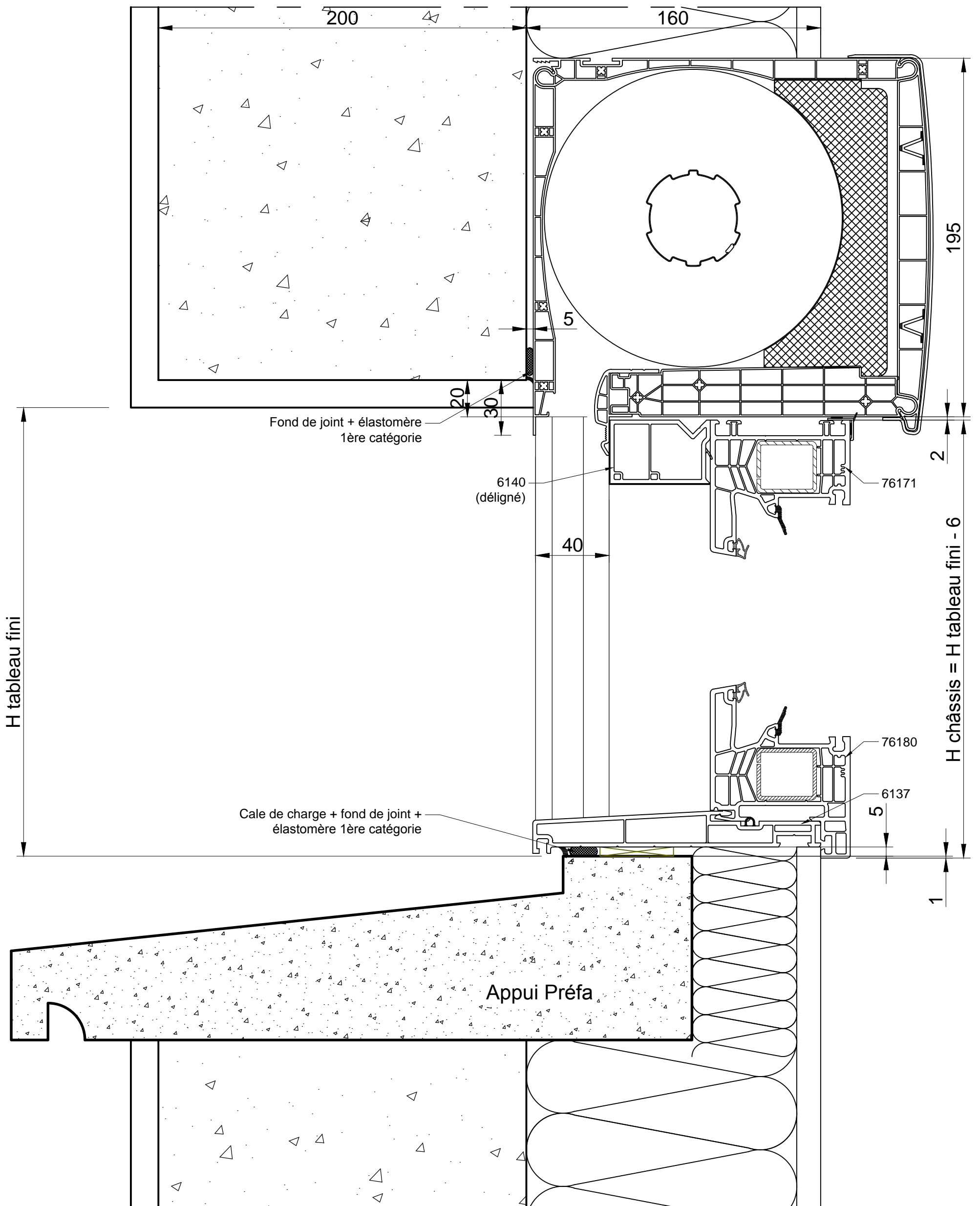

CATA TECH	Dessiné par E. TAVARES	Approuvé par N. BUERMANN	Coupe Verticale	Modifié le 26/11/2018	Date 06/11/2018	Echelle 1/2 - A3
 Fabricant de Fenêtres et Portes.			APPLIQUE RATRAPAGE ISO 160			
			MISE EN OEUVRE			Edition B

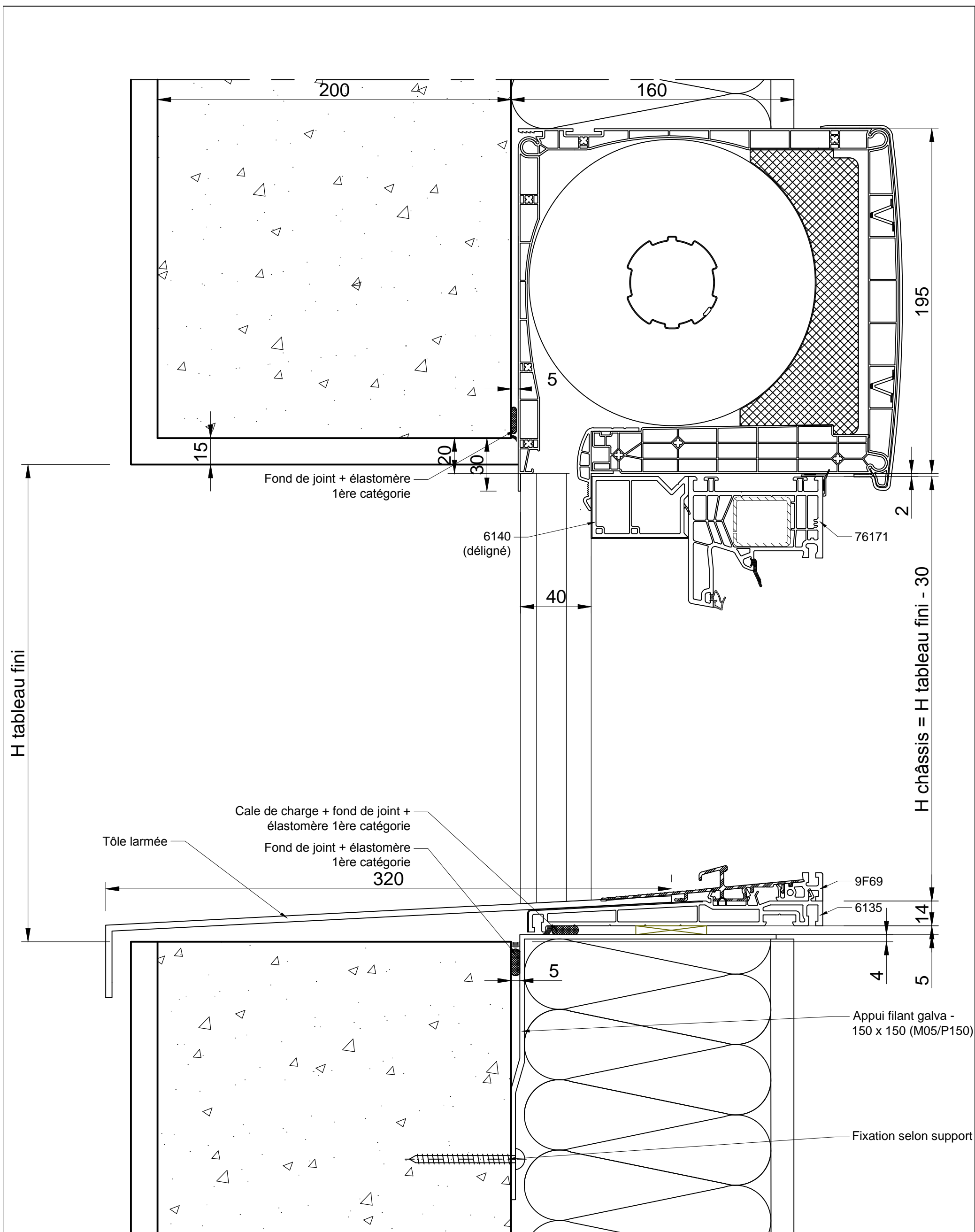

CATA TECH	Dessiné par E. TAVARES	Approuvé par N. BUERMANN	Coupe Verticale	Modifié le 26/11/2018	Date 06/11/2018	Echelle 1/2 - A3
 Fabricant de Fenêtres et Portes.			APPLIQUE RATTRAPAGE ISO 160			
			MISE EN OEUVRE			Edition B

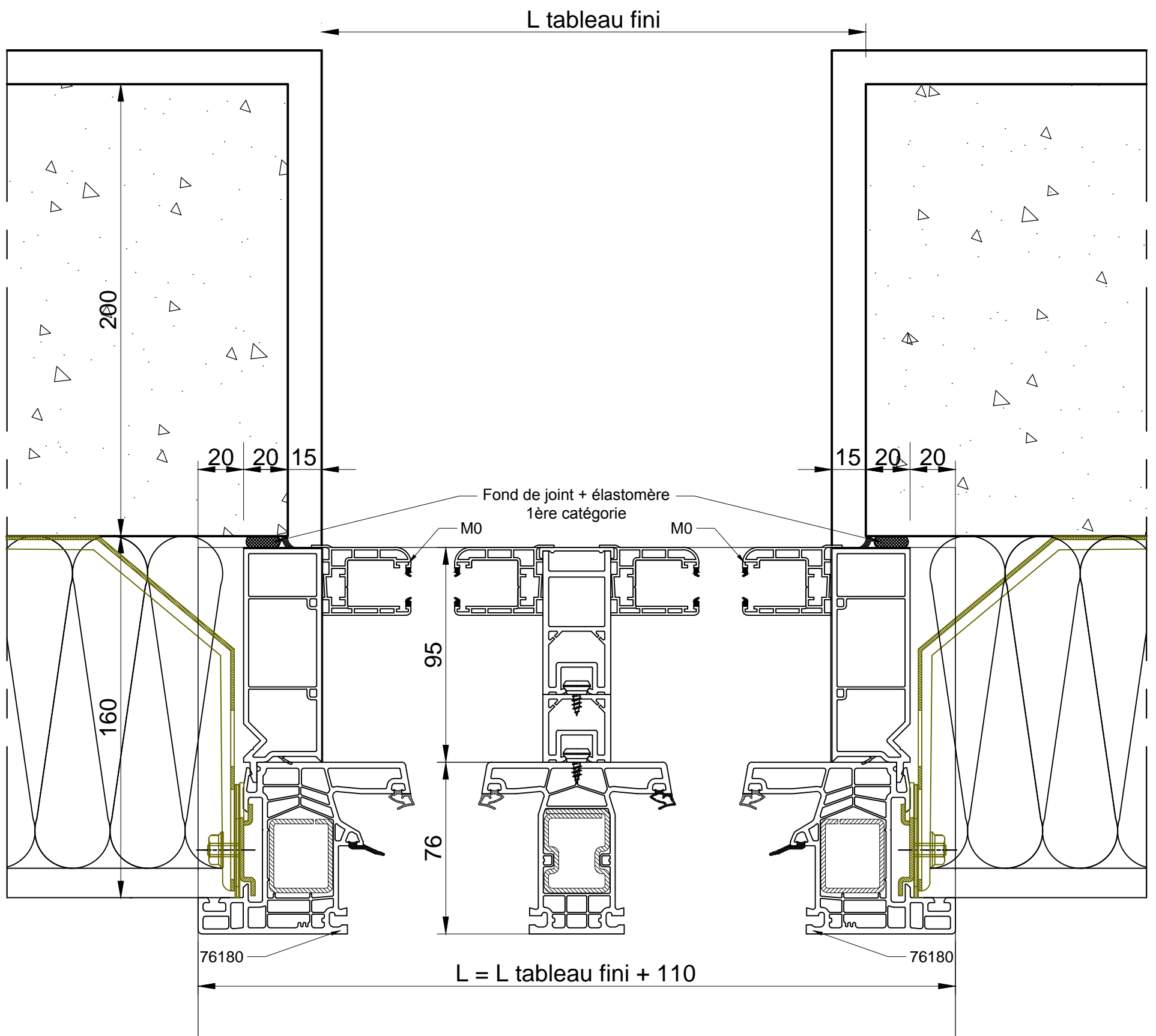

CATA TECH	Dessiné par E. TAVARES	Approuvé par N. BUERMANN	Coupe Verticale	Modifié le 26/11/2018	Date 06/11/2018	Echelle 1/2 - A3
 <p>hilzinger Fabricant de Fenêtres et Portes.</p>			APPLIQUE RATRAPAGE ISO 160			
			MISE EN OEUVRE			Edition B

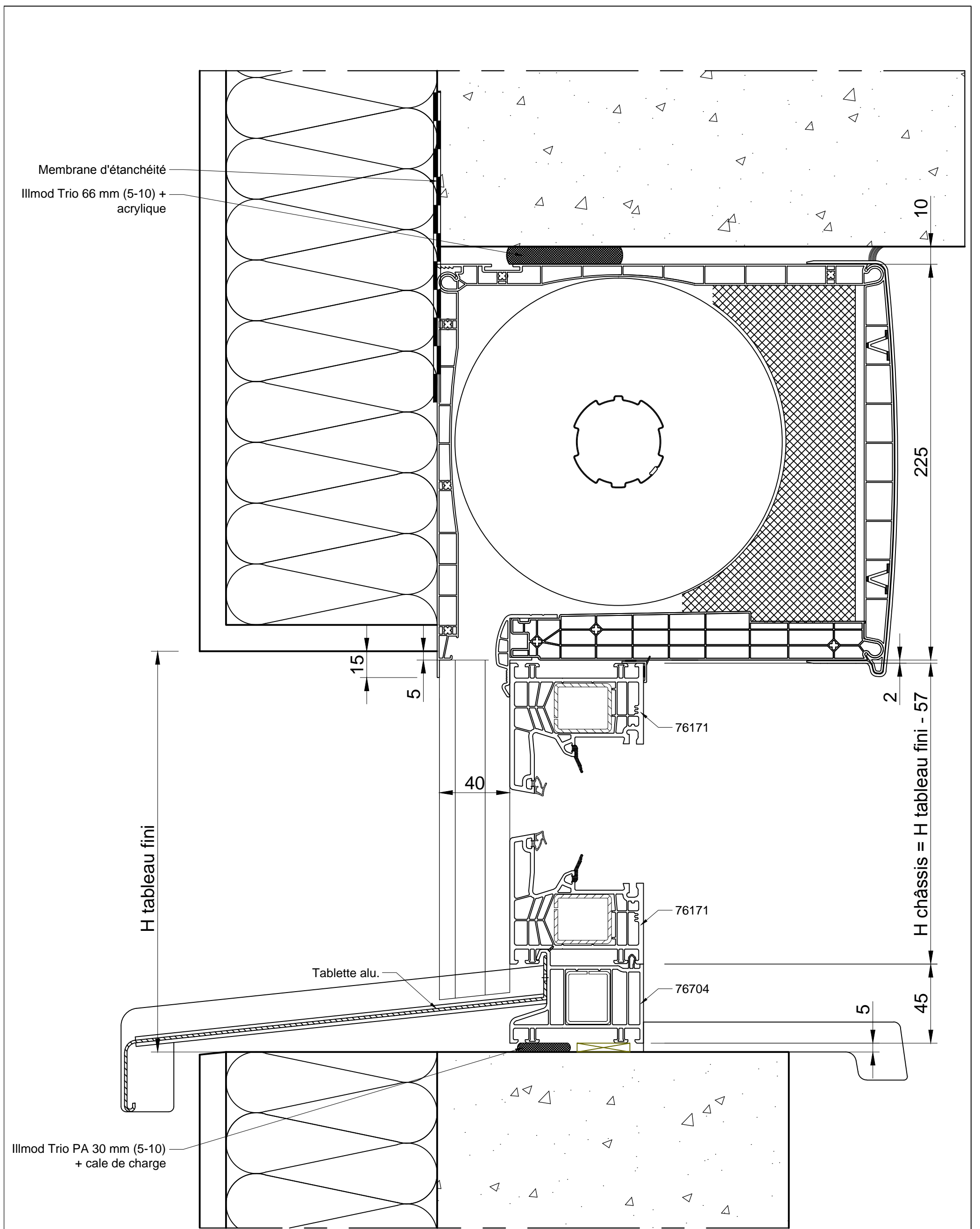

CATA TECH	Dessiné par E. TAVARES	Approuvé par N. BUERMANN	Coupe Verticale	Modifié le 26/11/2018	Date 06/11/2018	Echelle 1/2 - A3
 Fabricant de Fenêtres et Portes.			POSE EN TUNNEL			
			MISE EN OEUVRE	Edition B	Feuille No. PVC 50	

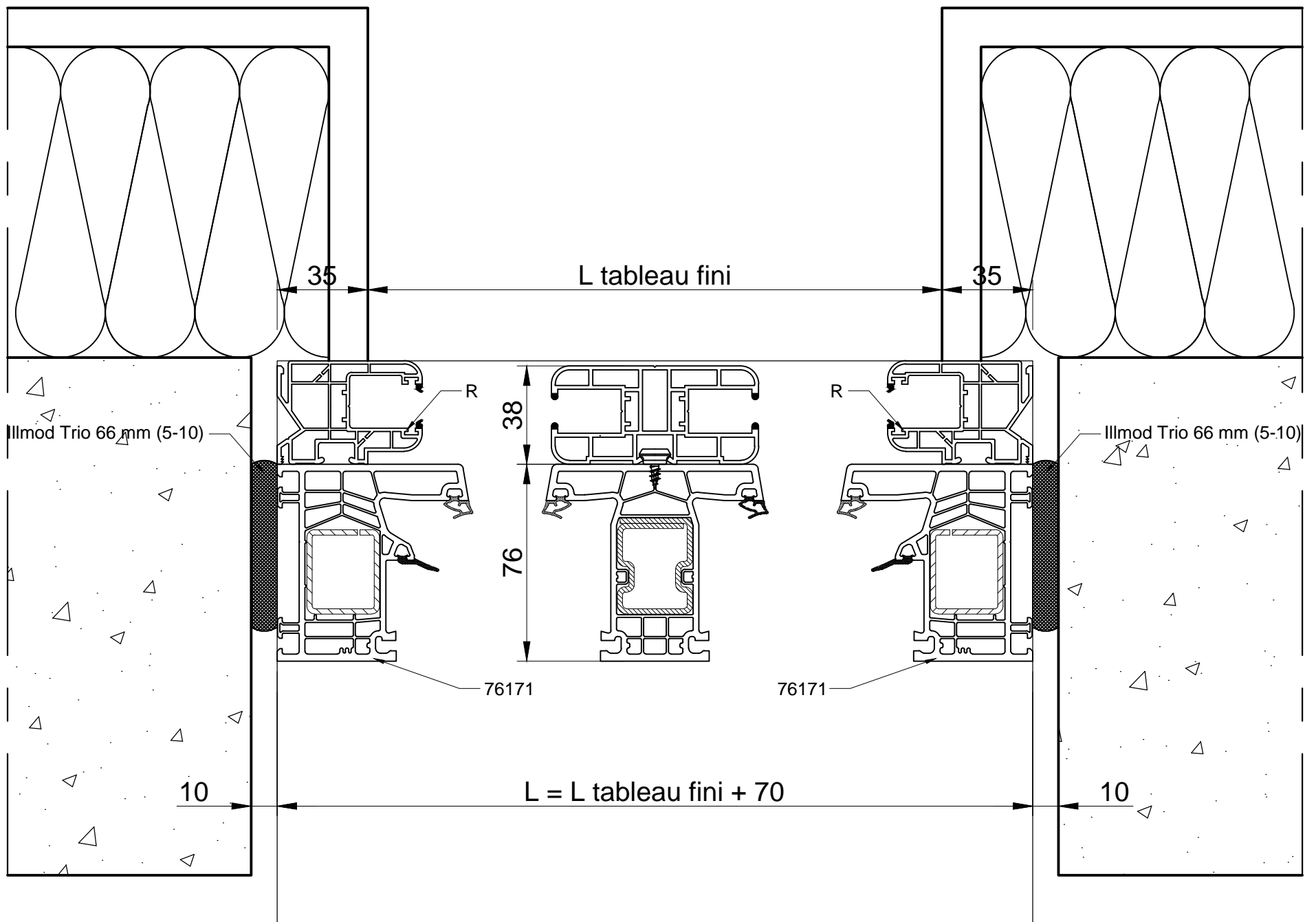

CATA TECH	Dessiné par E. TAVARES	Approuvé par N. BUERMANN	Coupe Verticale	Modifié le 26/11/2018	Date 06/11/2018	Echelle 1/2 - A3
 Fabricant de Fenêtres et Portes.			POSE EN TUNNEL			
			MISE EN OEUVRE	Edition B	Feuille No. PVC 51	

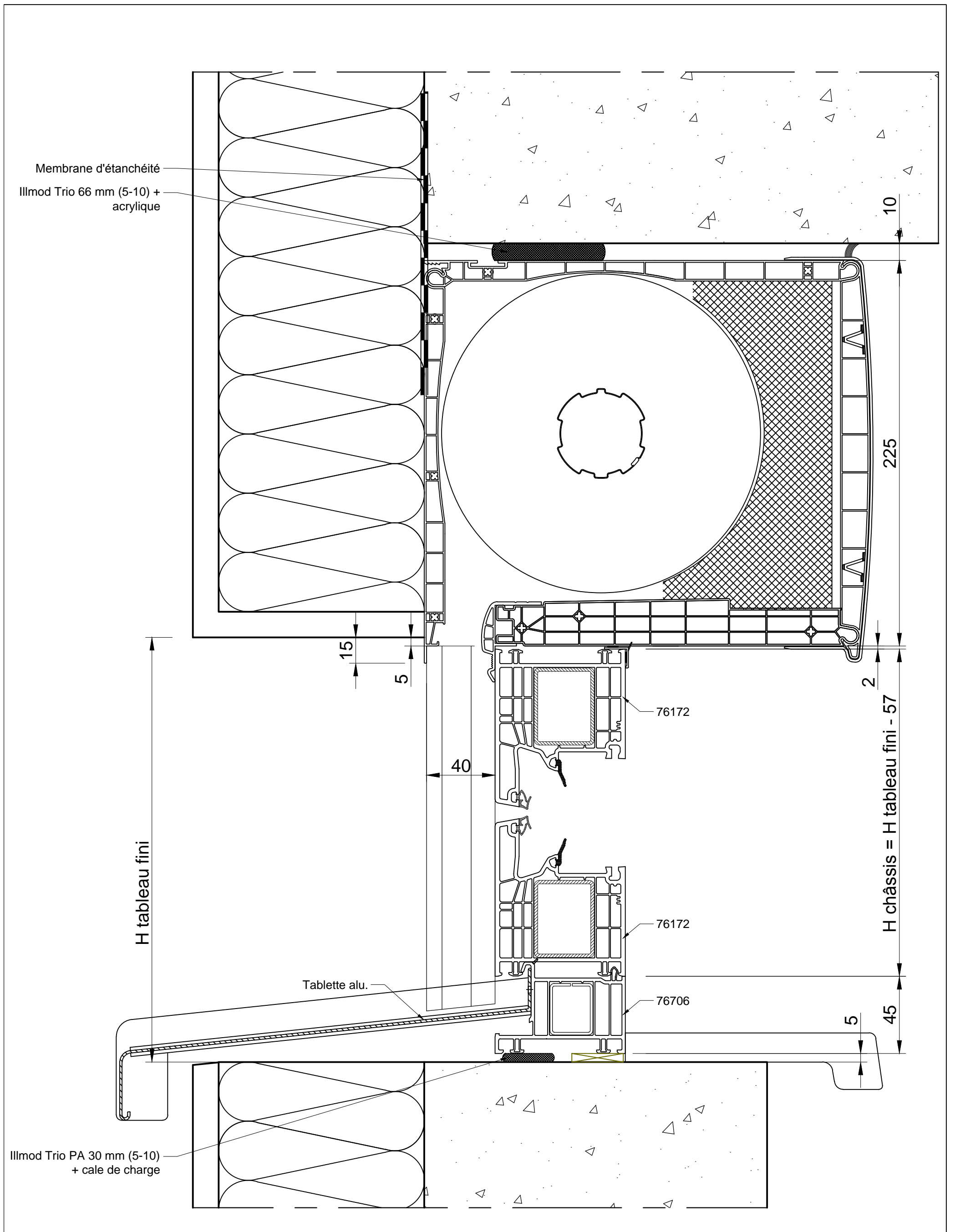

CATA TECH	Dessiné par E. TAVARES	Approuvé par N. BUERMANN	Coupe Verticale	Modifié le 26/11/2018	Date 06/11/2018	Echelle 1/2 - A3
 Fabricant de Fenêtres et Portes.			POSE EN TUNNEL			
			MISE EN OEUVRE	Edition B	Feuille No. PVC 52	

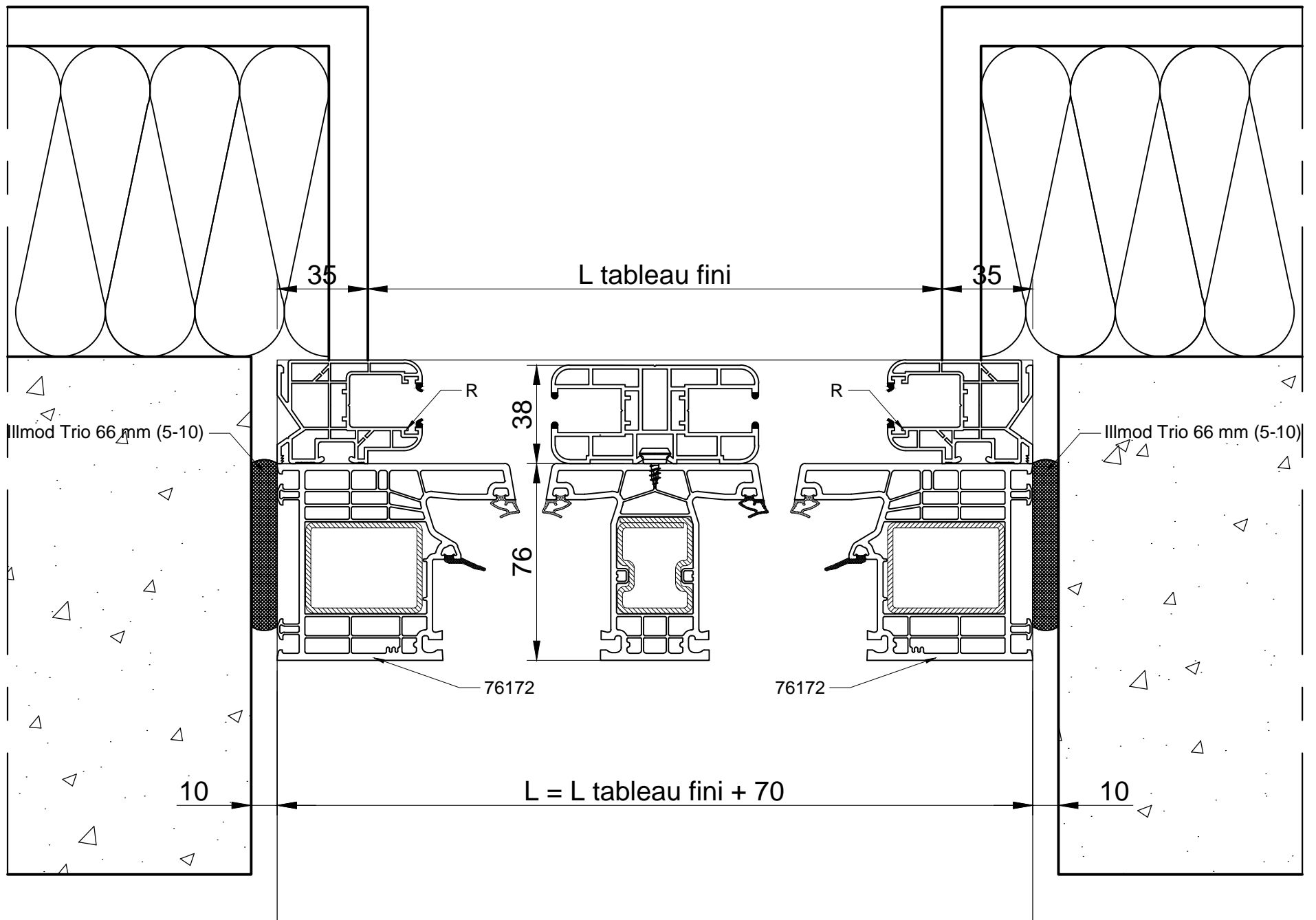

CATA TECH	Dessiné par E. TAVARES	Approuvé par N. BUERMANN	Coupe Verticale	Modifié le 26/11/2018	Date 06/11/2018	Echelle 1/2 - A3
 Fabricant de Fenêtres et Portes.			POSE EN TUNNEL			
			MISE EN OEUVRE	Edition B	Feuille No. PVC 53	

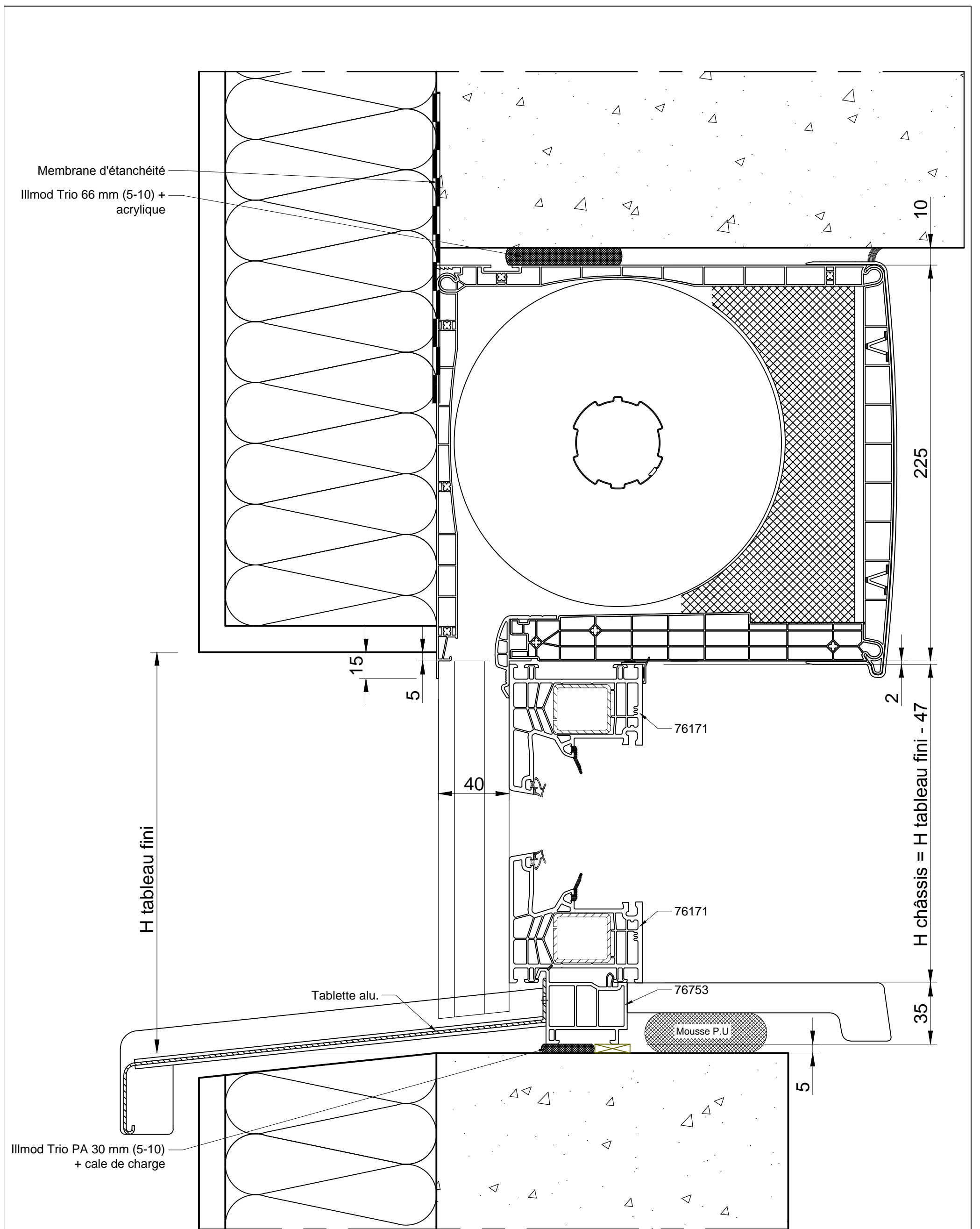

CATA TECH	Dessiné par E. TAVARES	Approuvé par N. BUERMANN	Coupe Verticale	Modifié le 26/11/2018	Date 06/11/2018	Echelle 1/2 - A3
 Fabricant de Fenêtres et Portes.			POSE EN TUNNEL			
			MISE EN OEUVRE	Edition B	Feuille No. PVC 54	

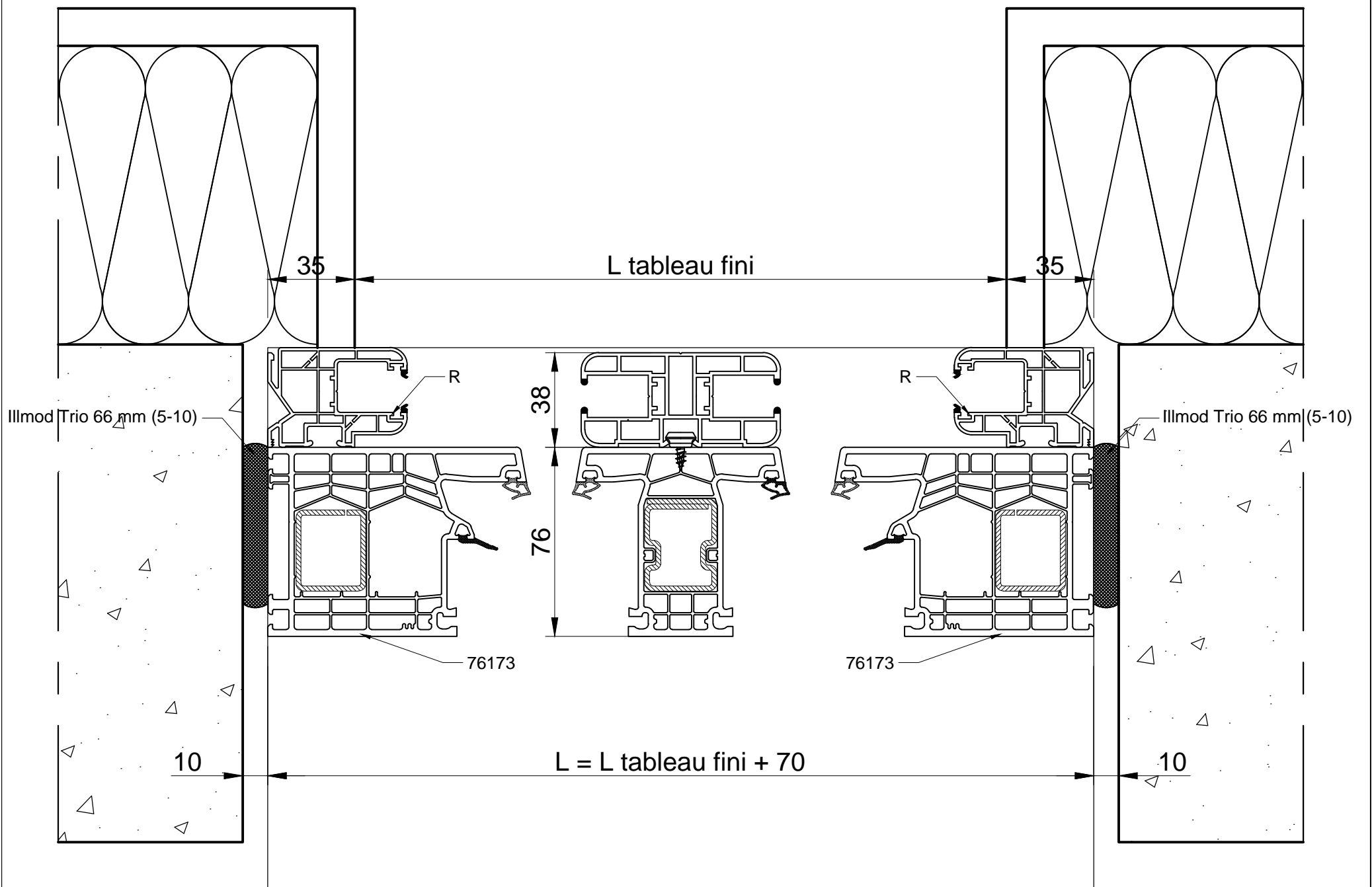

CATA TECH	Dessiné par E. TAVARES	Approuvé par N. BUERMANN	Coupe Verticale	Modifié le 26/11/2018	Date 06/11/2018	Echelle 1/2 - A3
 Fabricant de Fenêtres et Portes.			POSE EN TUNNEL			
			MISE EN OEUVRE	Edition B	Feuille No. PVC 55	

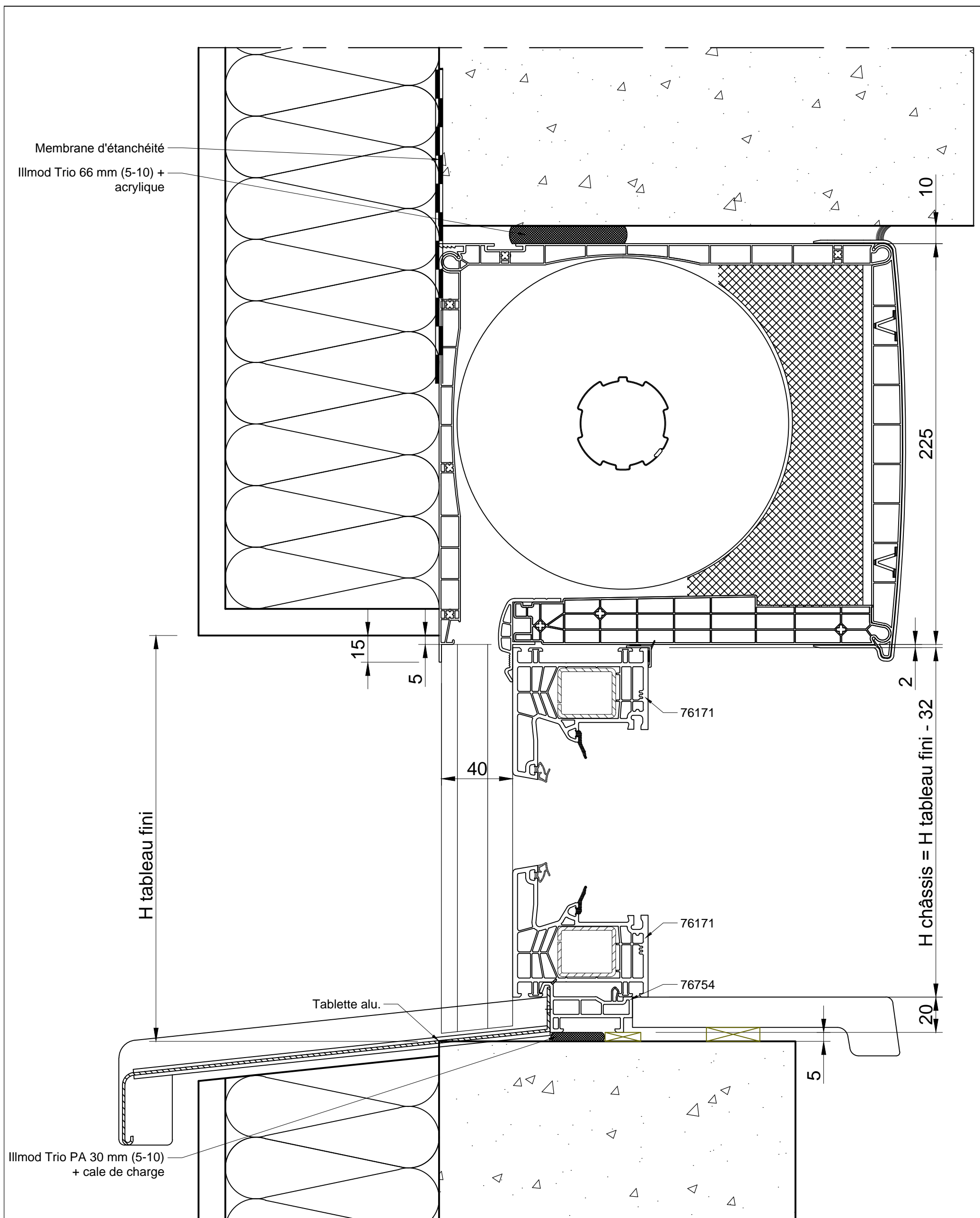

CATA TECH	Dessiné par E. TAVARES	Approuvé par N. BUERMANN	Coupe Verticale	Modifié le 26/11/2018	Date 06/11/2018	Echelle 1/2 - A3
 Fabricant de Fenêtres et Portes.			POSE EN TUNNEL			
			MISE EN OEUVRE	Edition B	Feuille No. PVC 56	

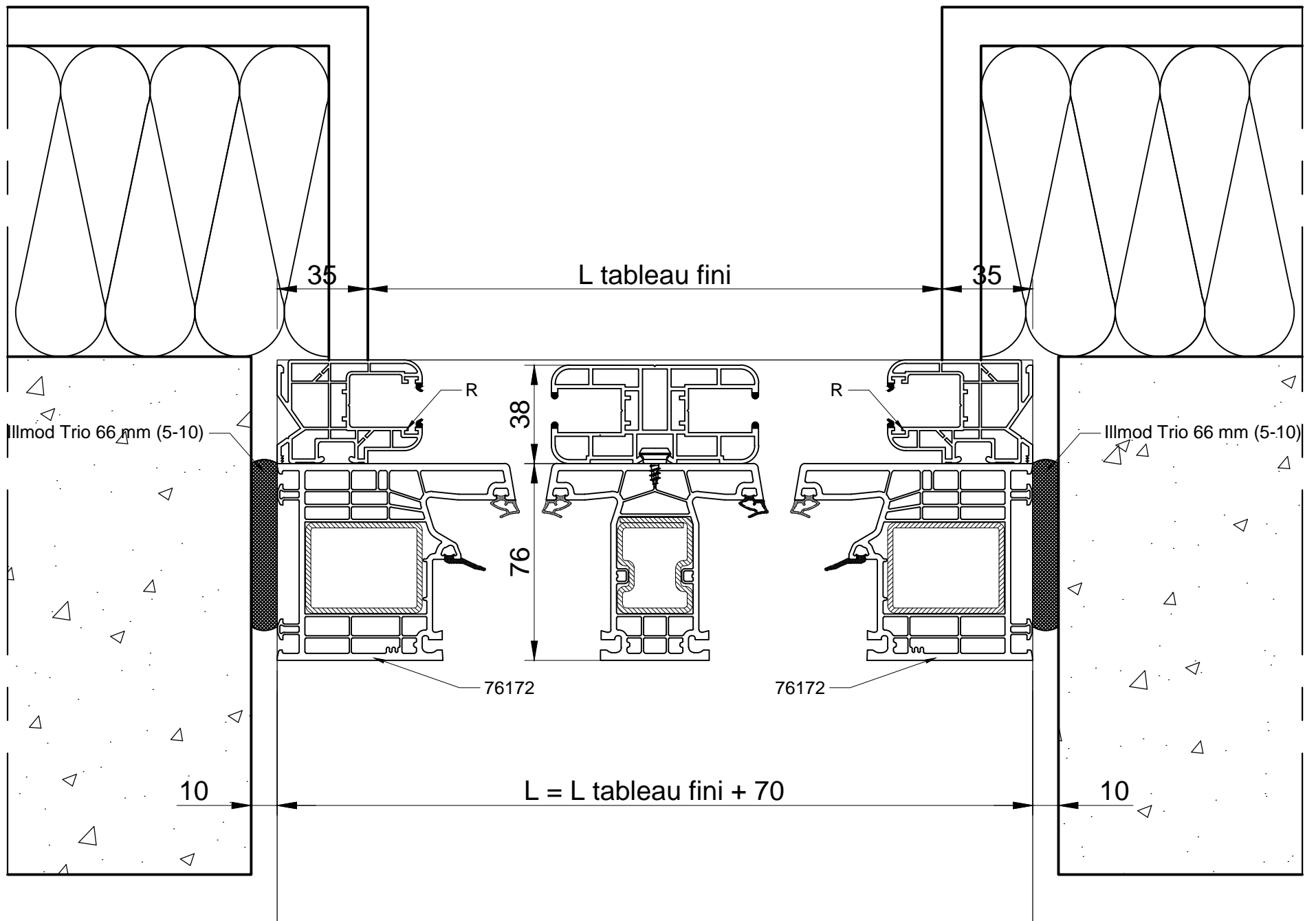

CATA TECH	Dessiné par E. TAVARES	Approuvé par N. BUERMANN	Coupe Verticale	Modifié le 26/11/2018	Date 06/11/2018	Echelle 1/2 - A3
 Fabricant de Fenêtres et Portes.			POSE EN TUNNEL			
			MISE EN OEUVRE	Edition B	Feuille No. PVC 57	

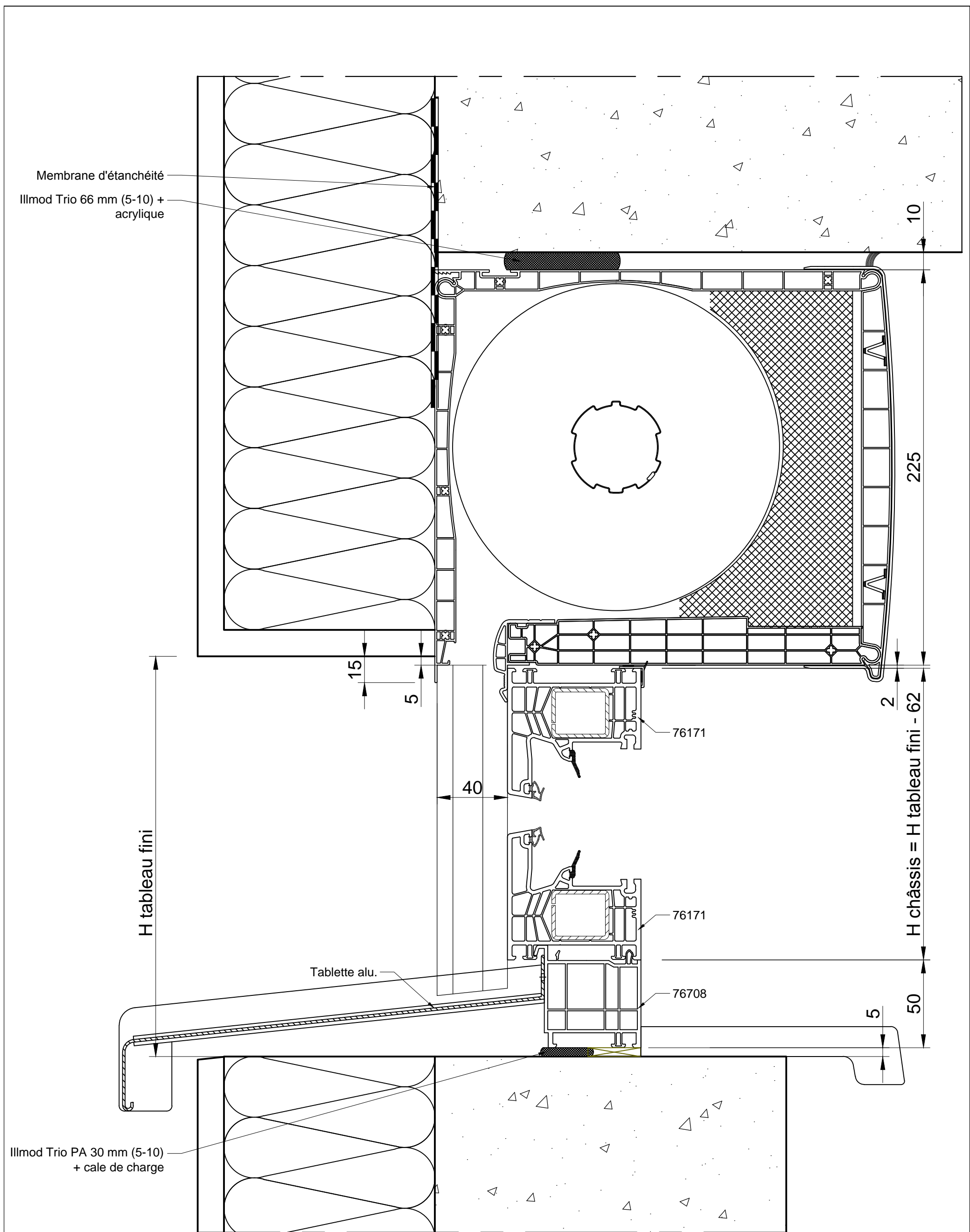

CATA TECH	Dessiné par E. TAVARES	Approuvé par N. BUERMANN	Coupe Verticale	Modifié le 26/11/2018	Date 06/11/2018	Echelle 1/2 - A3
 Fabricant de Fenêtres et Portes.			POSE EN TUNNEL			
			MISE EN OEUVRE	Edition B	Feuille No. PVC 58	

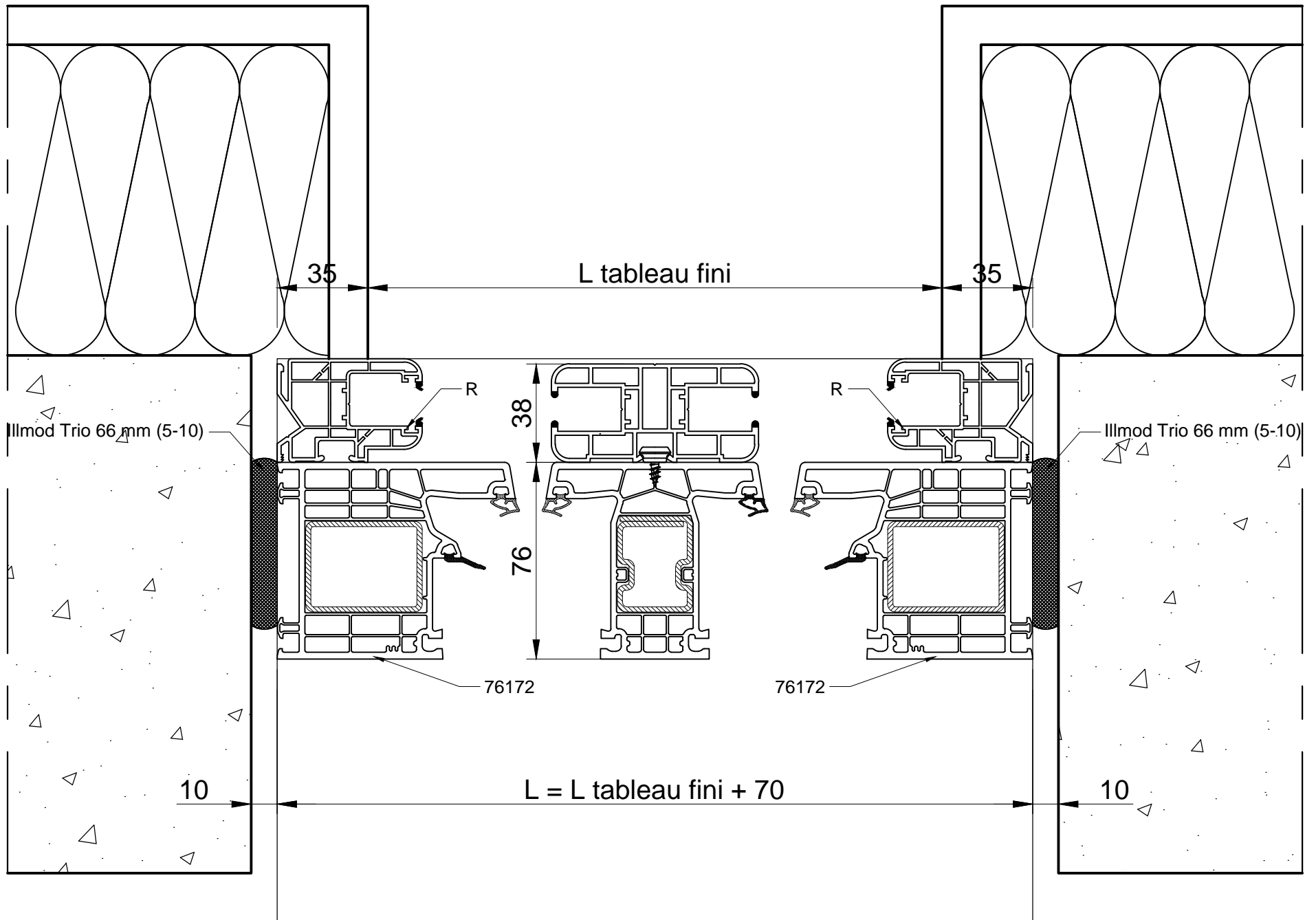

CATA TECH	Dessiné par E. TAVARES	Approuvé par N. BUERMANN	Coupe Verticale	Modifié le 26/11/2018	Date 06/11/2018	Echelle 1/2 - A3
 Fabricant de Fenêtres et Portes.			POSE EN TUNNEL			
			MISE EN OEUVRE	Edition B	Feuille No. PVC 59	

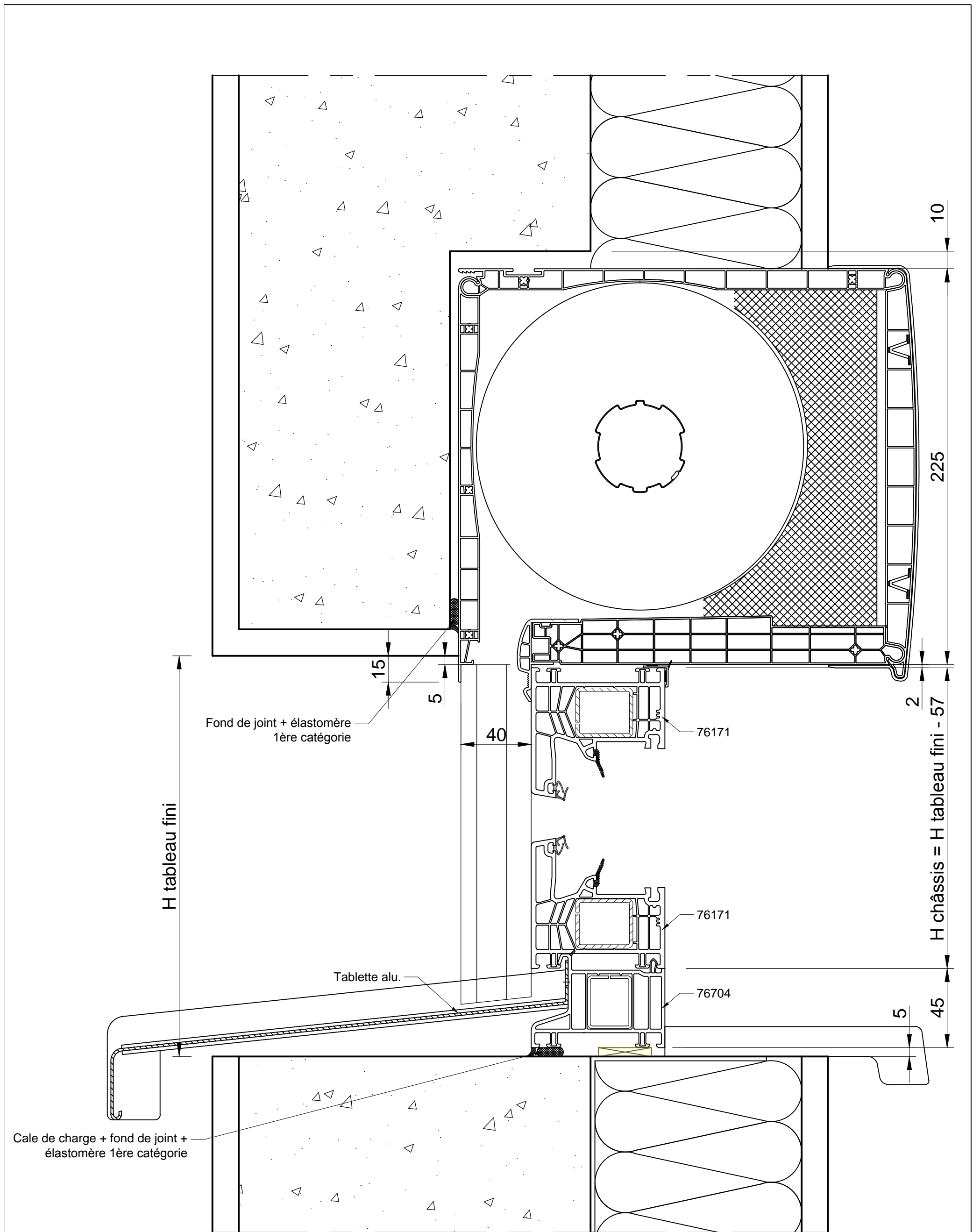

CATA TECH	Dessiné par E. TAVARES	Approuvé par N. BUERMANN	Coupe Verticale	Modifié le 26/11/2018	Date 06/11/2018	Echelle 1/2 - A3
 Fabricant de Fenêtres et Portes.			POSE EN FEUILLURE			
			MISE EN OEUVRE	Edition B	Feuille No. PVC 60	

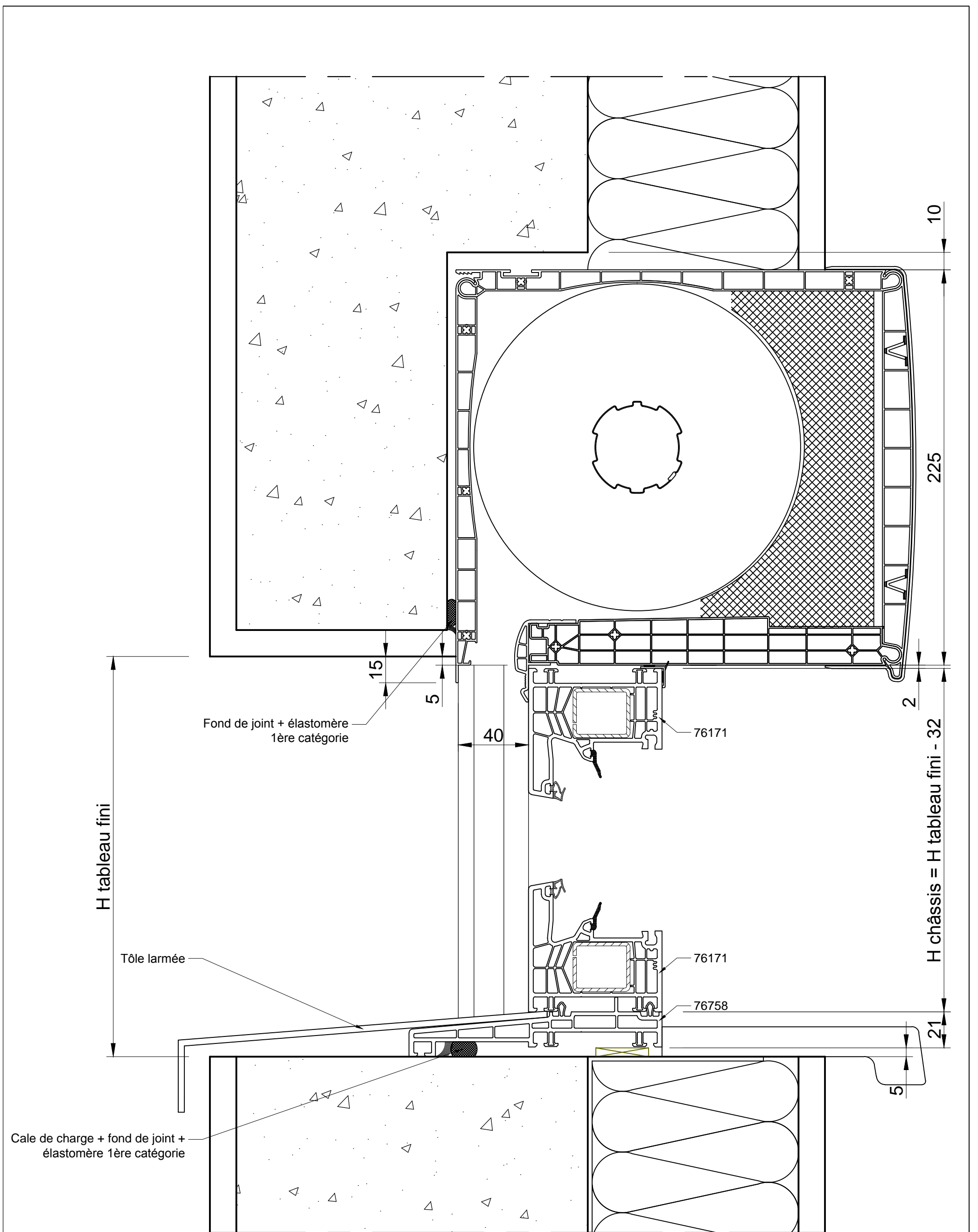

CATA TECH	Dessiné par E. TAVARES	Approuvé par N. BUERMANN	Coupe Verticale	Modifié le 26/11/2018	Date 06/11/2018	Echelle 1/2 - A3
 <p>hilzinger Fabricant de Fenêtres et Portes.</p>			POSE EN FEUILLURE			
			MISE EN OEUVRE	Edition B	Feuille No. PVC 61	

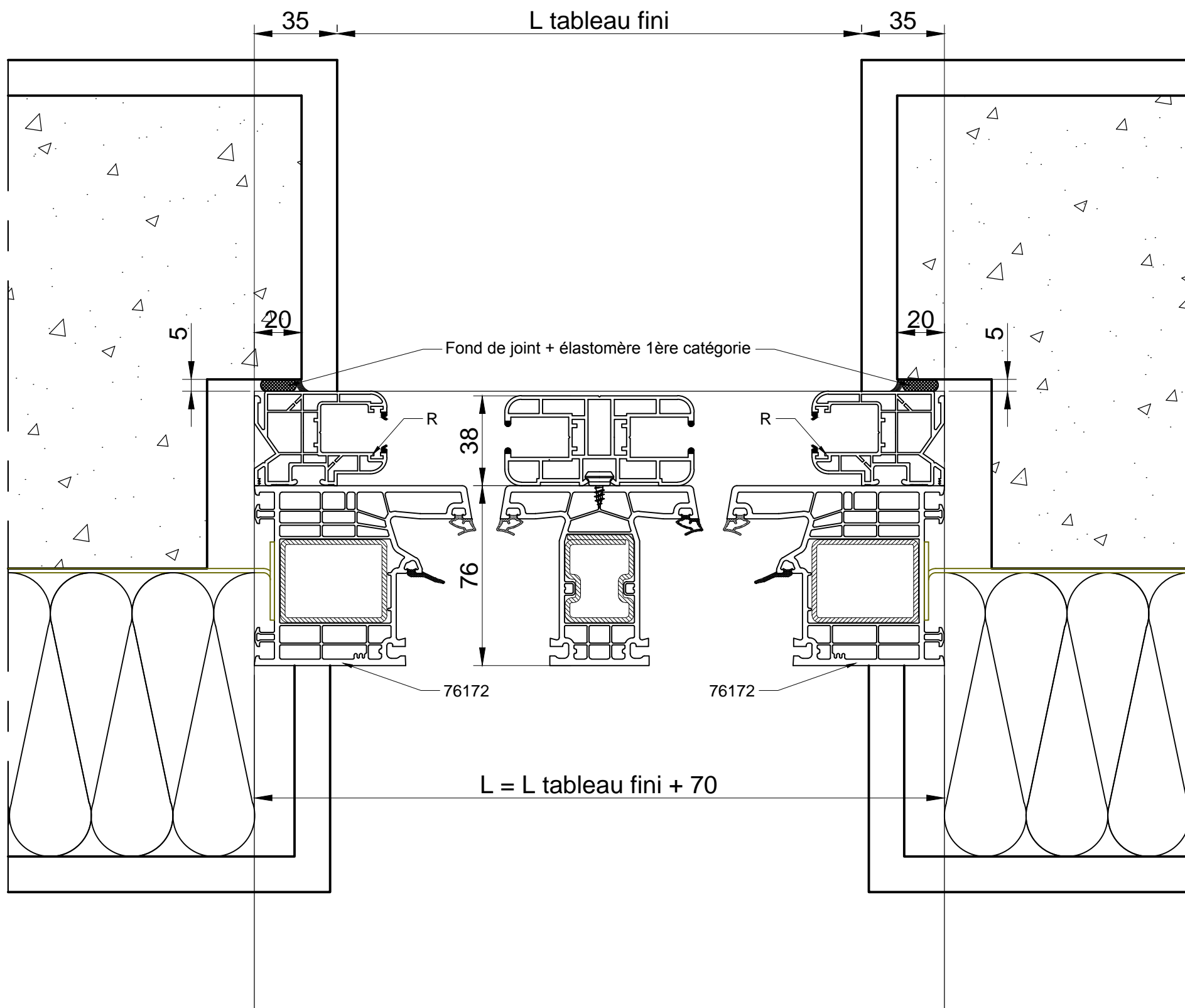

CATA TECH	Dessiné par E. TAVARES	Approuvé par N. BUERMANN	Coupe Verticale	Modifié le 26/11/2018	Date 06/11/2018	Echelle 1/2 - A3
 Fabricant de Fenêtres et Portes.			POSE EN FEUILLURE			
			MISE EN OEUVRE	Edition B	Feuille No. PVC 62	

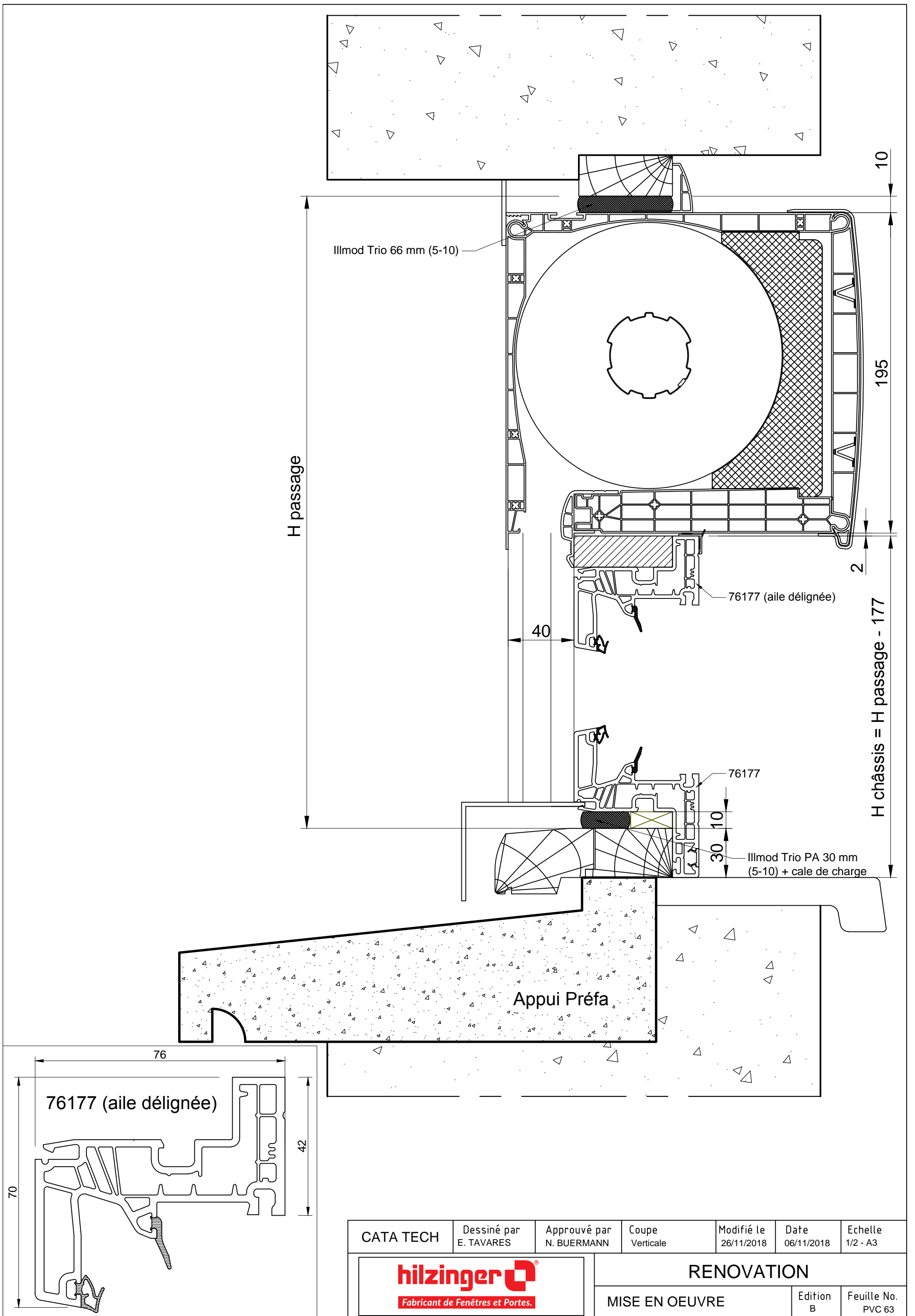

CATA TECH	Dessiné par E. TAVARES	Approuvé par N. BUERMANN	Coupe Verticale	Modifié le 26/11/2018	Date 06/11/2018	Echelle 1/2 - A3
 <p>hilzinger Fabricant de Fenêtres et Portes.</p>			RENOVATION			
			MISE EN OEUVRE		Edition B	Feuille No. PVC 63

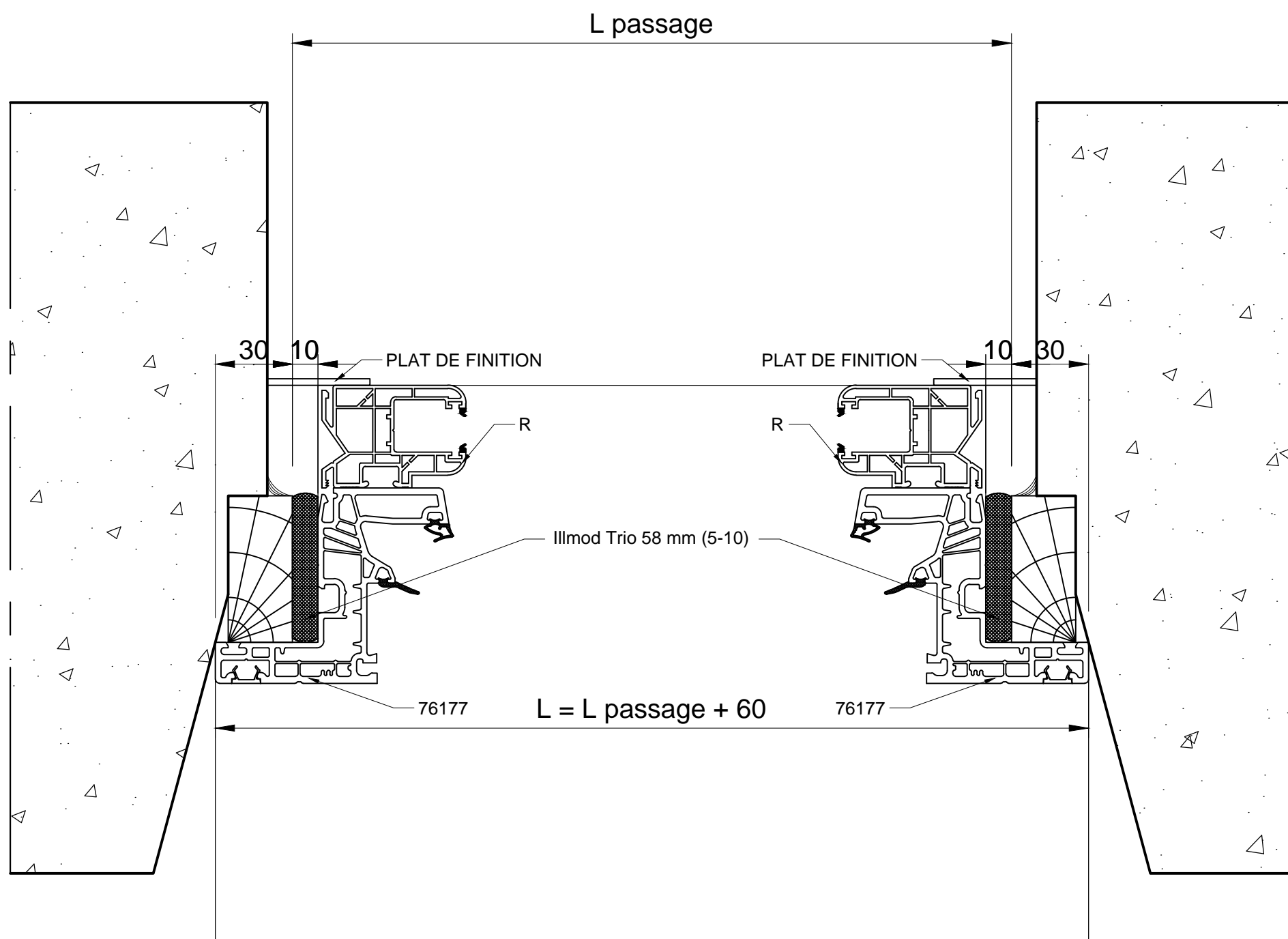

CATA TECH	Dessiné par E. TAVARES	Approuvé par N. BUERMANN	Coupe Verticale	Modifié le 26/11/2018	Date 06/11/2018	Echelle 1/2 - A3
 Fabricant de Fenêtres et Portes.			RENOVATION			
			MISE EN OEUVRE	Edition B	Feuille No. PVC 64	

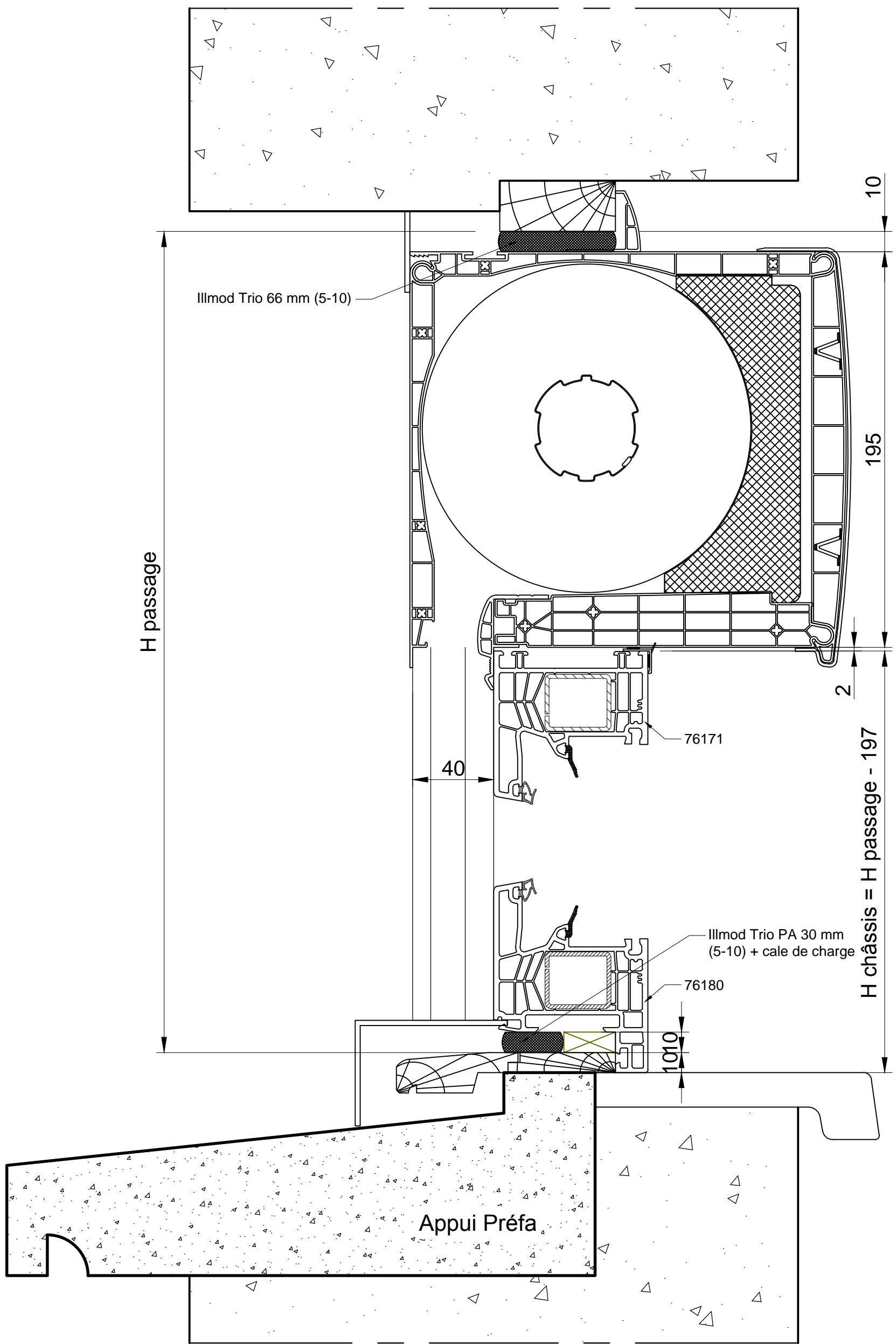

CATA TECH	Dessiné par E. TAVARES	Approuvé par N. BUERMANN	Coupe Verticale	Modifié le 26/11/2018	Date 06/11/2018	Echelle 1/2 - A3
 Fabricant de Fenêtres et Portes.			RENOVATION			
			MISE EN OEUVRE	Edition B	Feuille No. PVC 65	

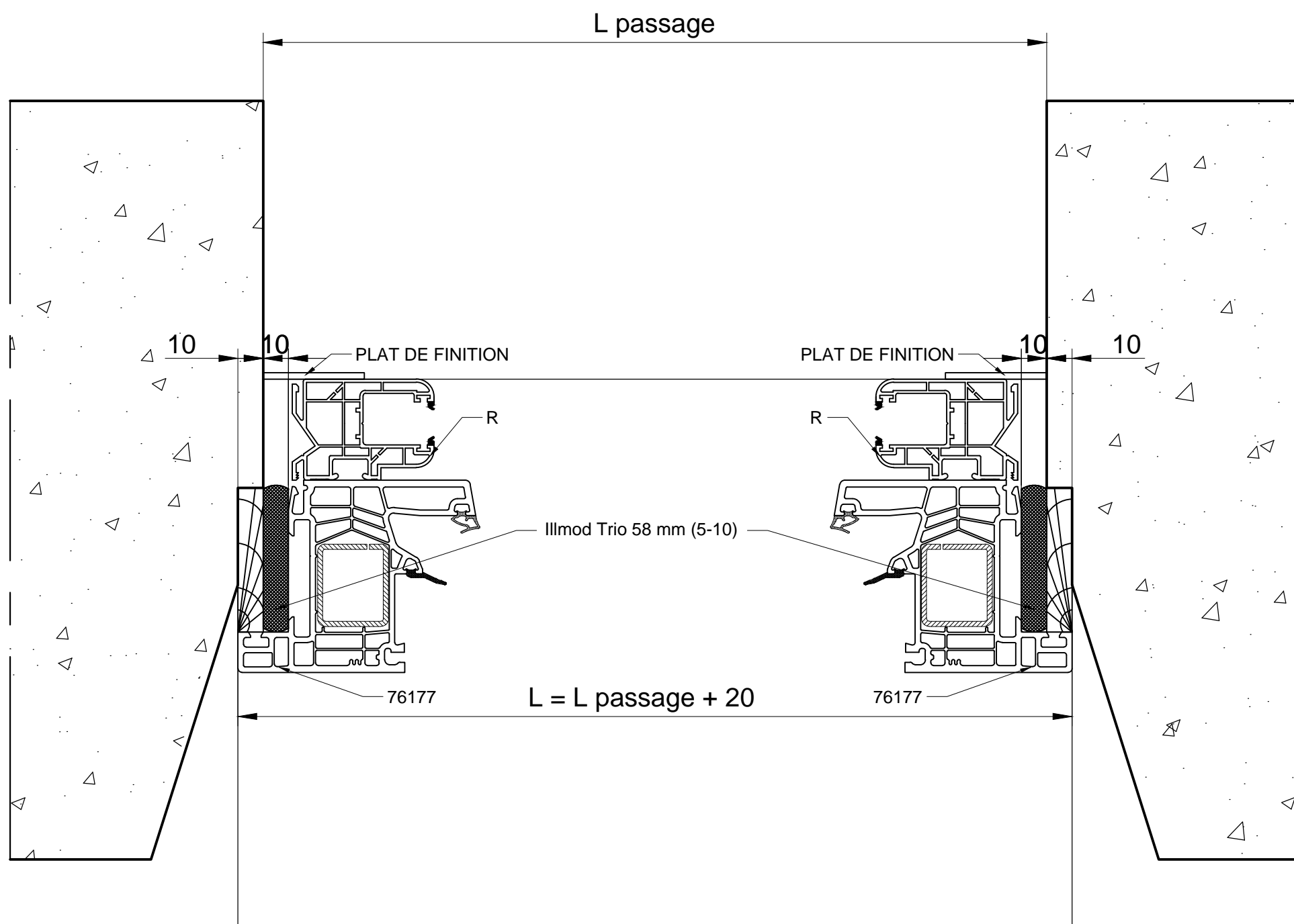

CATA TECH	Dessiné par E. TAVARES	Approuvé par N. BUERMANN	Coupe Verticale	Modifié le 26/11/2018	Date 06/11/2018	Echelle 1/2 - A3
 Fabricant de Fenêtres et Portes.			RENOVATION			
			MISE EN OEUVRE			Edition B

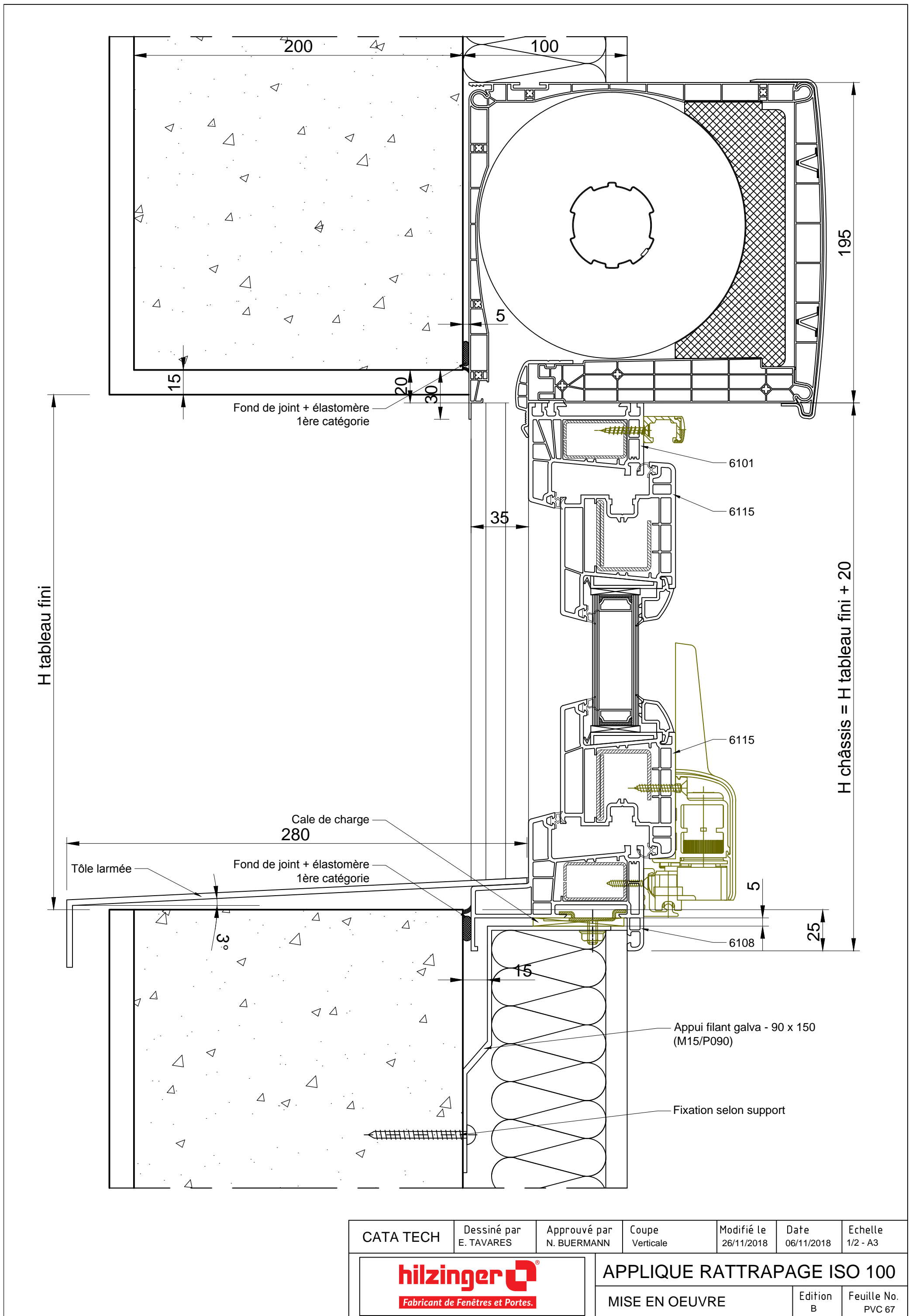

CATA TECH	Dessiné par E. TAVARES	Approuvé par N. BUERMANN	Coupe Verticale	Modifié le 26/11/2018	Date 06/11/2018	Echelle 1/2 - A3
 Fabricant de Fenêtres et Portes.			APPLIQUE RATTRAPAGE ISO 100			
			MISE EN OEUVRE			Edition B

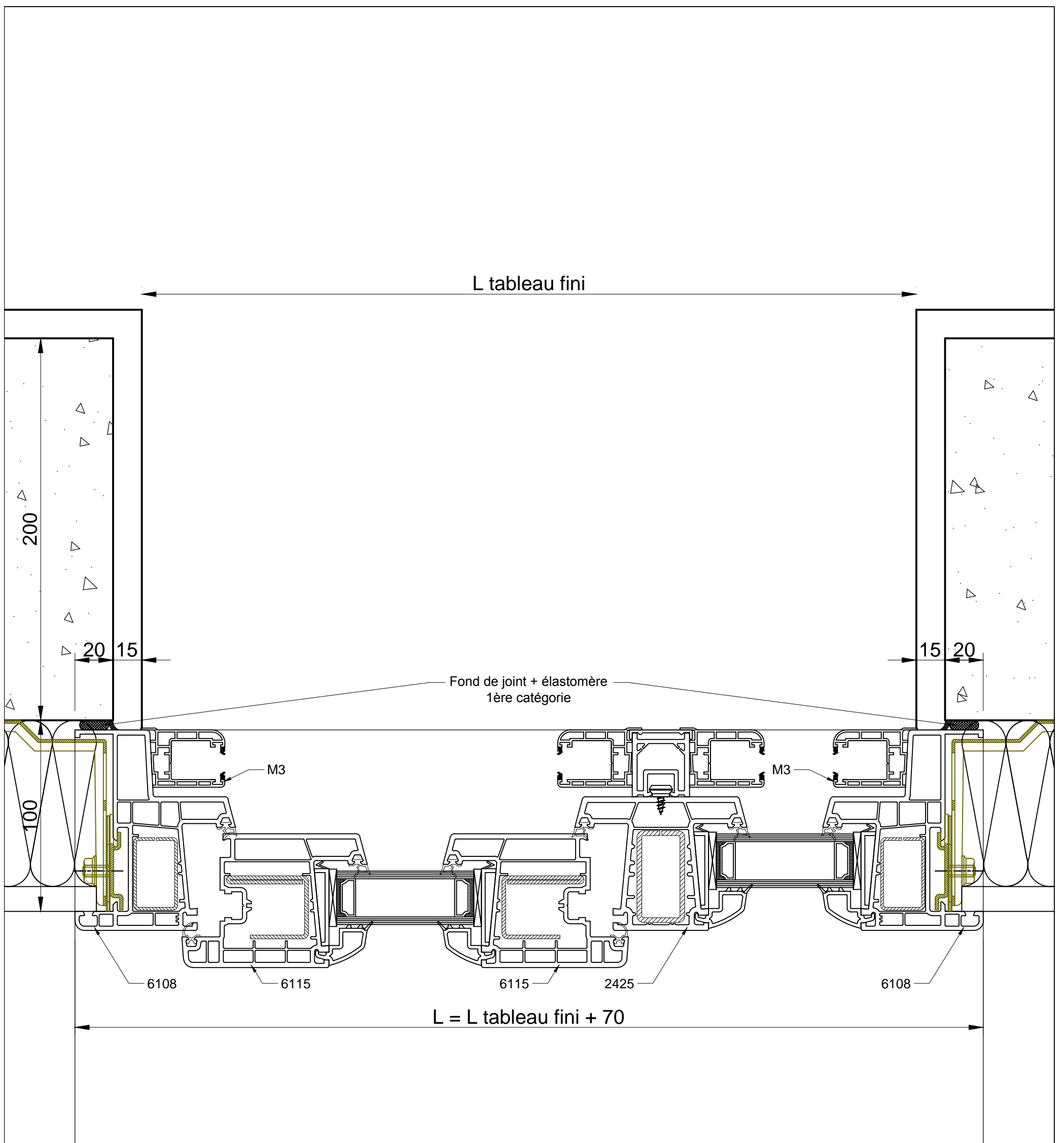

CATA TECH	Dessiné par E. TAVARES	Approuvé par N. BUERMANN	Coupe Verticale	Modifié le 26/11/2018	Date 06/11/2018	Echelle 1/2 - A3
 Fabricant de Fenêtres et Portes.			APPLIQUE RATRAPAGE ISO 100			
			MISE EN OEUVRE			Edition B

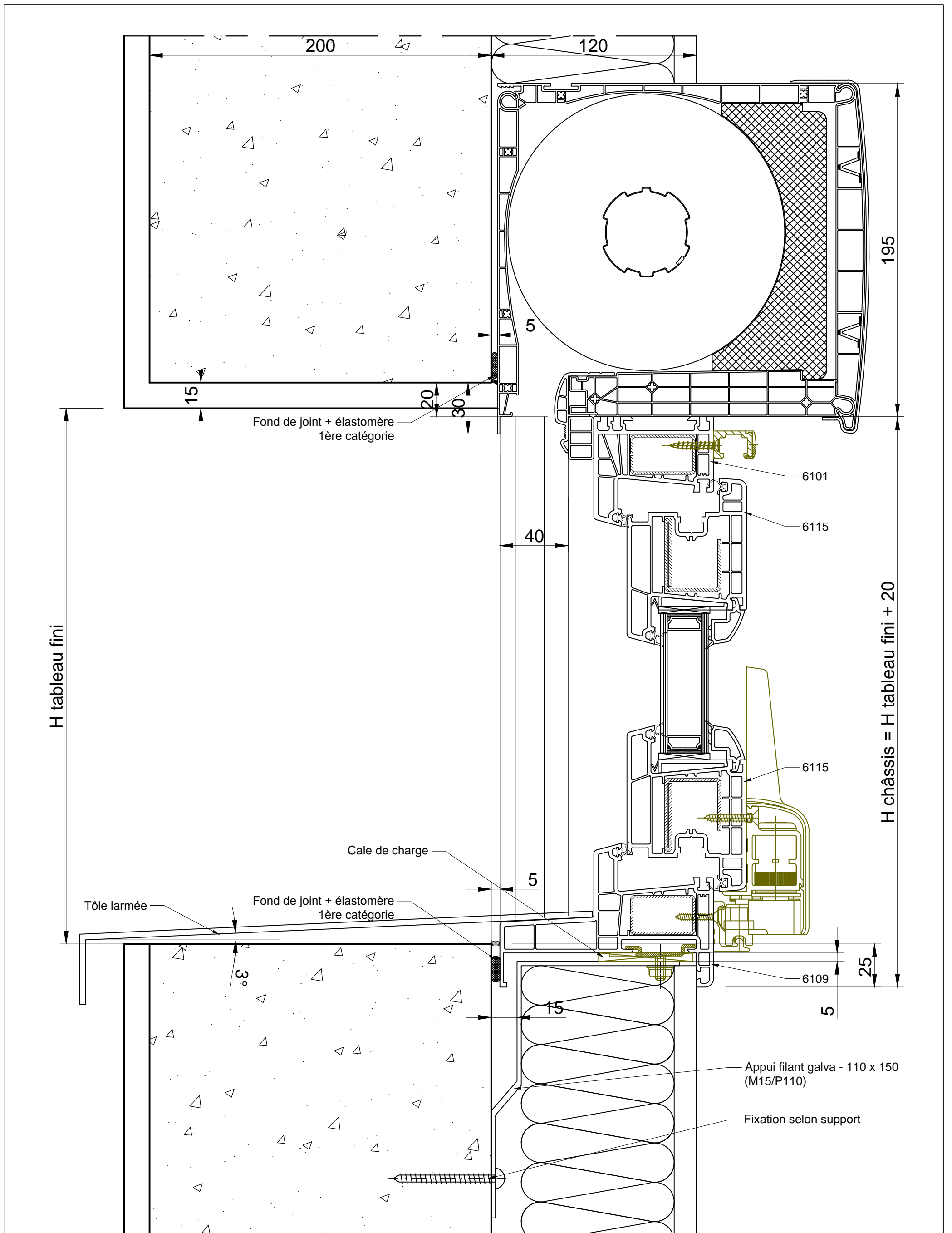

CATA TECH	Dessiné par E. TAVARES	Approuvé par N. BUERMANN	Coupe Verticale	Modifié le 26/11/2018	Date 06/11/2018	Echelle 1/2 - A3
 Fabricant de Fenêtres et Portes.			APPLIQUE RATTRAPAGE ISO 120			
			MISE EN OEUVRE			Edition B

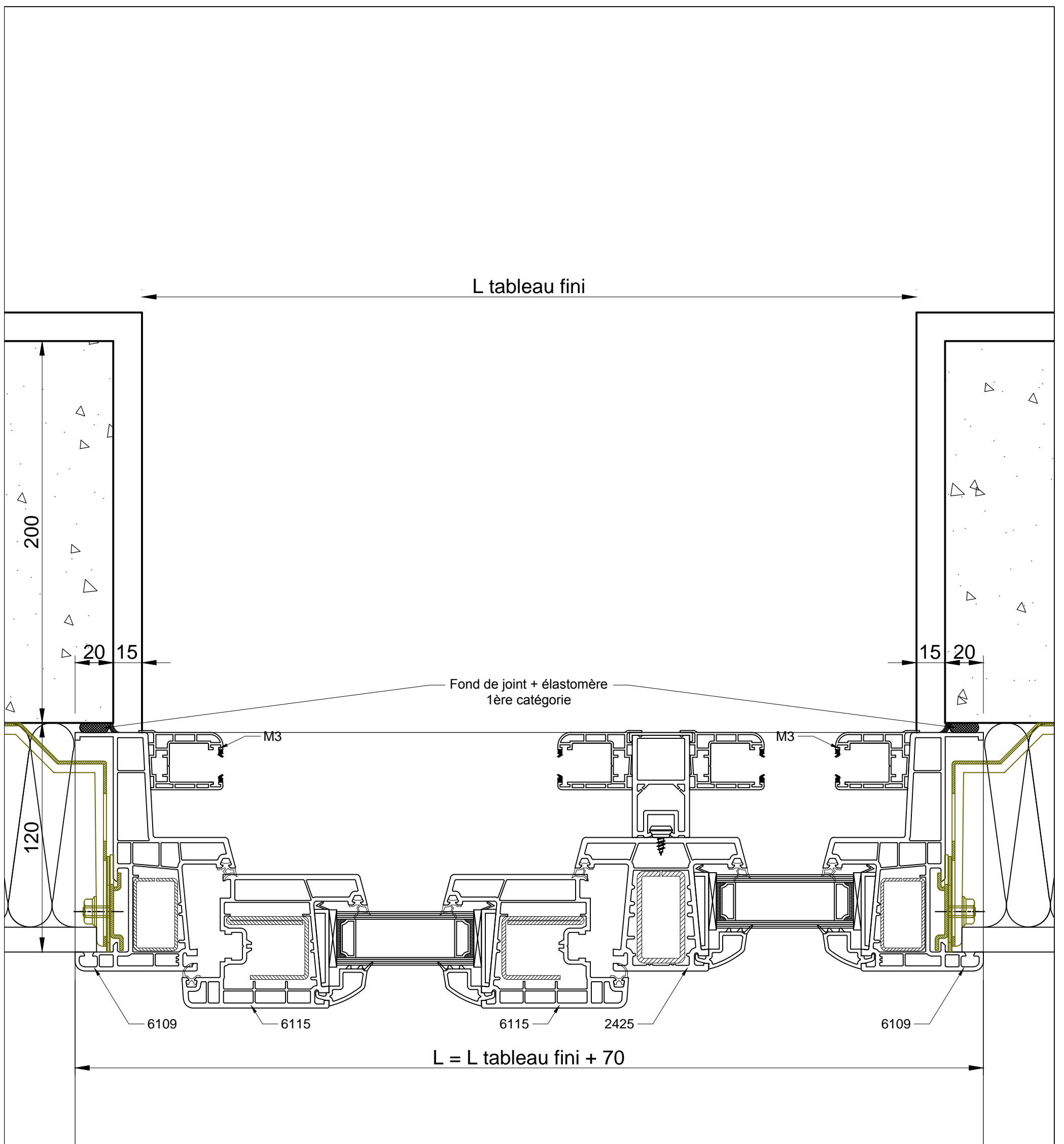

CATA TECH	Dessiné par E. TAVARES	Approuvé par N. BUERMANN	Coupe Verticale	Modifié le 26/11/2018	Date 06/11/2018	Echelle 1/2 - A3
 Fabricant de Fenêtres et Portes.			APPLIQUE RATTRAPAGE ISO 120			
			MISE EN OEUVRE			Edition B

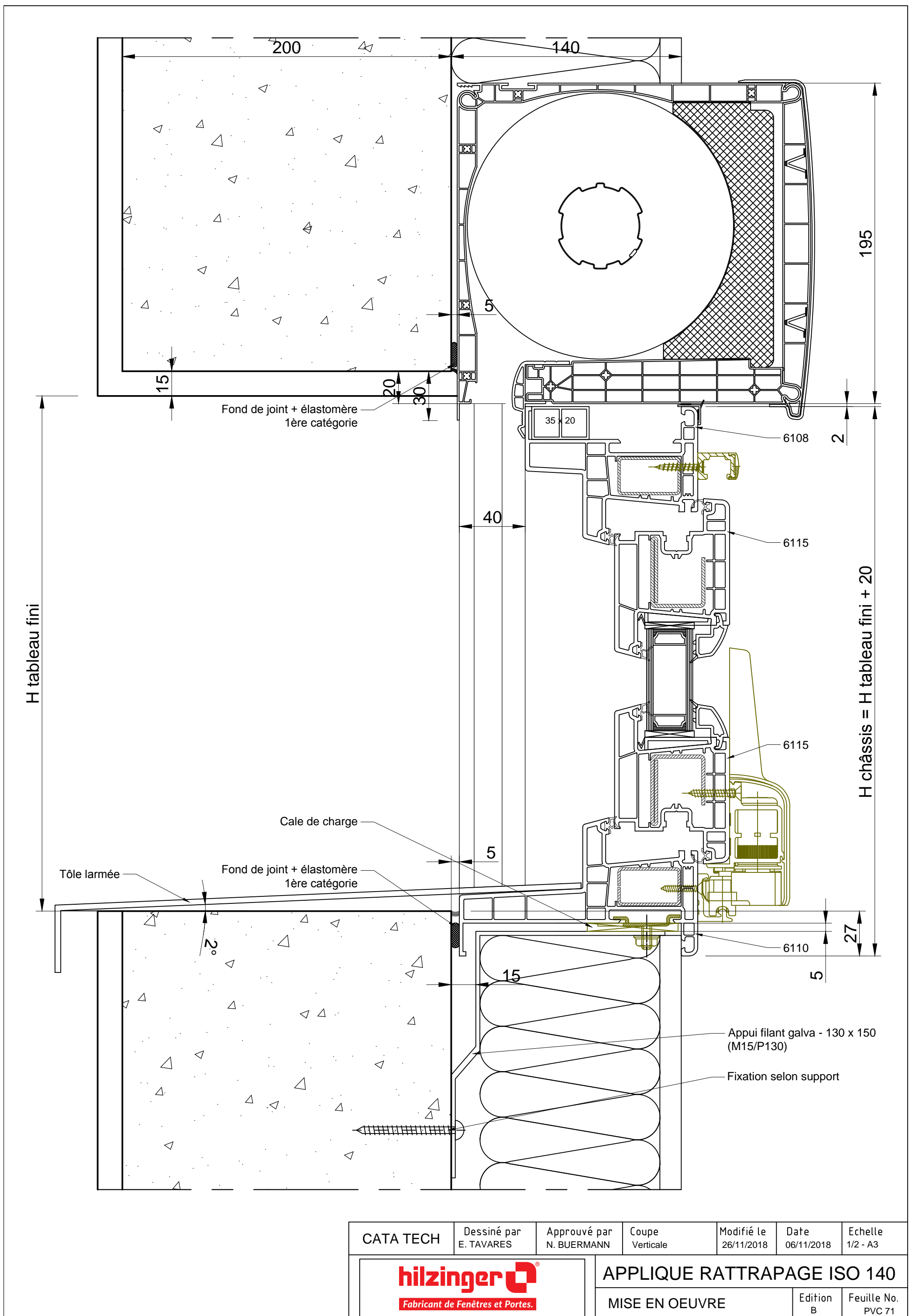

CATA TECH	Dessiné par E. TAVARES	Approuvé par N. BUERMANN	Coupe Verticale	Modifié le 26/11/2018	Date 06/11/2018	Echelle 1/2 - A3
 <p>hilzinger Fabricant de Fenêtres et Portes.</p>			APPLIQUE RATTRAPAGE ISO 140			
			MISE EN OEUVRE			Edition B

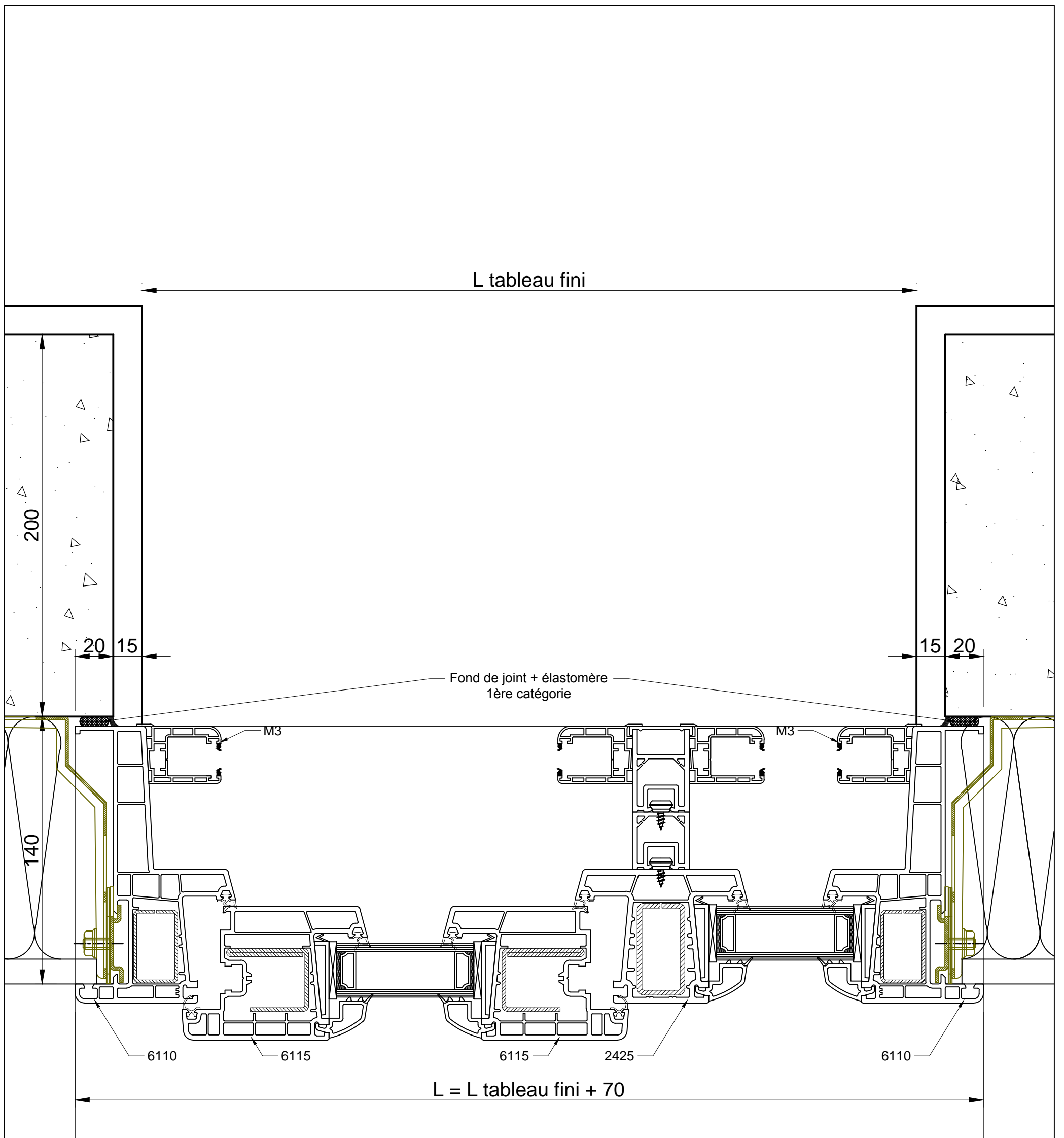

CATA TECH	Dessiné par E. TAVARES	Approuvé par N. BUERMANN	Coupe Verticale	Modifié le 26/11/2018	Date 06/11/2018	Echelle 1/2 - A3
 Fabricant de Fenêtres et Portes.			APPLIQUE RATTRAPAGE ISO 140			
			MISE EN OEUVRE			Edition B

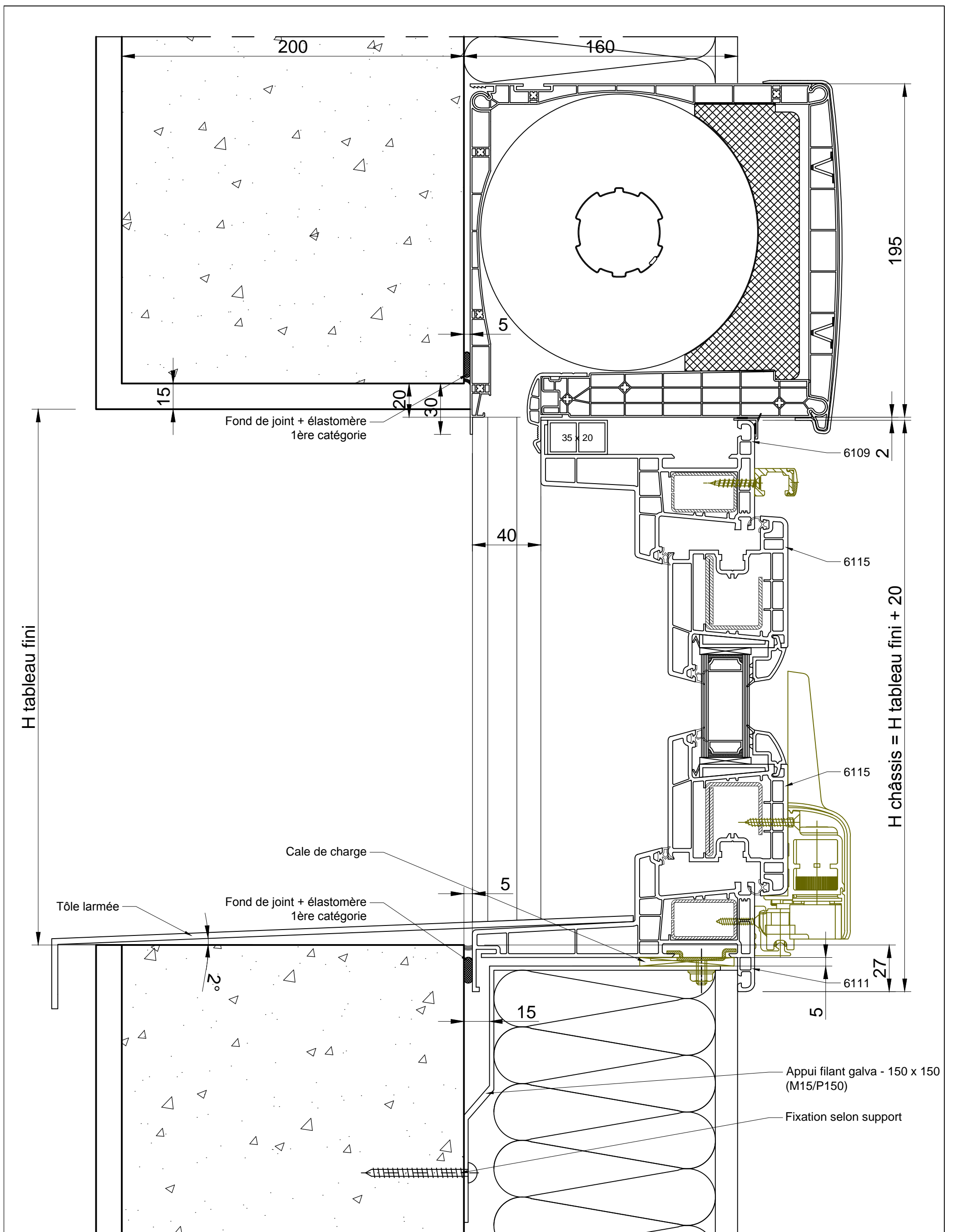

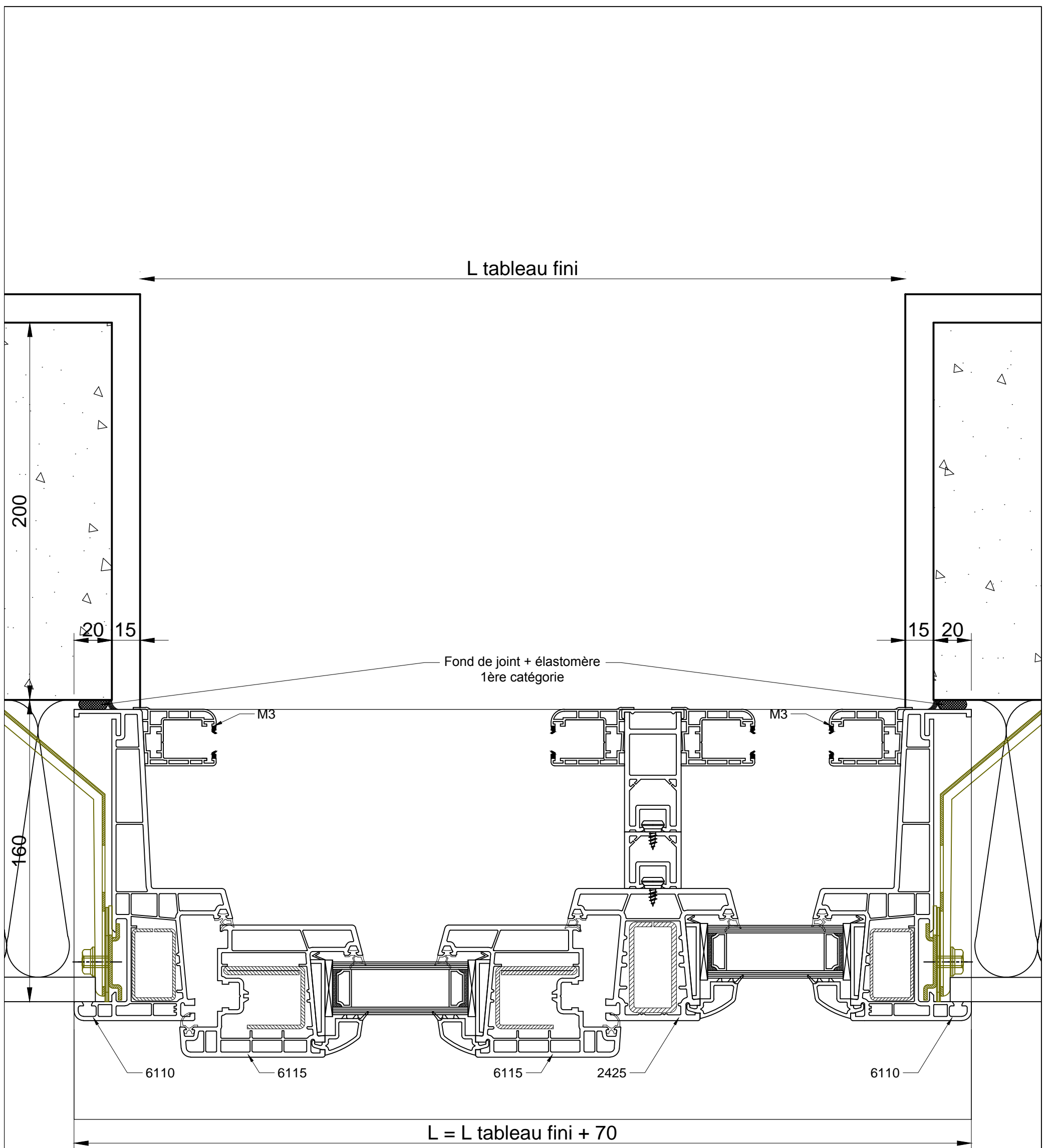

CATA TECH	Dessiné par E. TAVARES	Approuvé par N. BUERMANN	Coupe Verticale	Modifié le 26/11/2018	Date 06/11/2018	Echelle 1/2 - A3
 Fabricant de Fenêtres et Portes.			APPLIQUE RATTRAPAGE ISO 160			
			MISE EN OEUVRE			Edition B

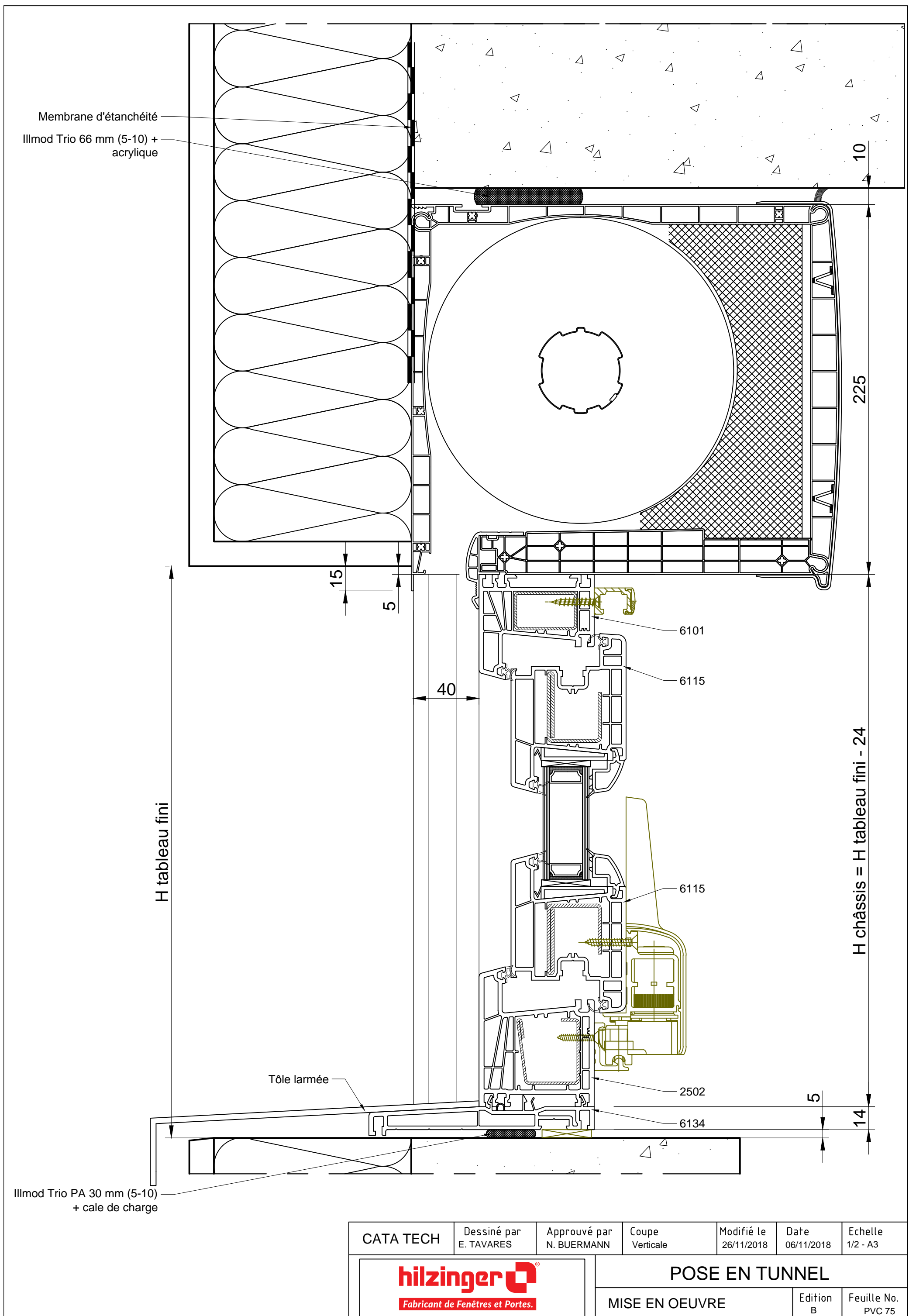

CATA TECH	Dessiné par E. TAVARES	Approuvé par N. BUERMANN	Coupe Verticale	Modifié le 26/11/2018	Date 06/11/2018	Echelle 1/2 - A3
 Fabricant de Fenêtres et Portes.			APPLIQUE RATTRAPAGE ISO 160			
			MISE EN OEUVRE			Edition B

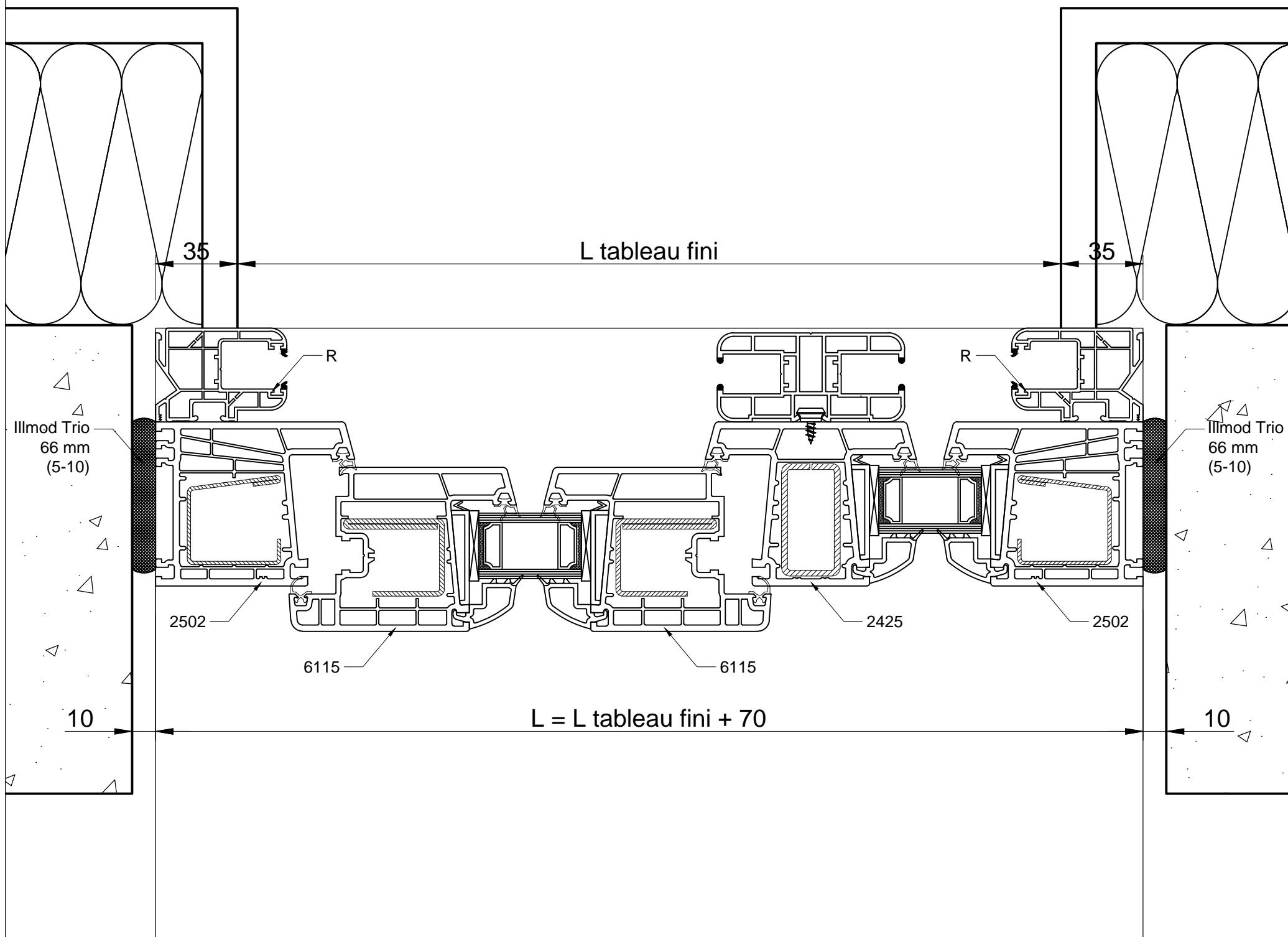



CATA TECH	Dessiné par E. TAVARES	Approuvé par N. BUERMANN	Coupe Verticale	Modifié le 26/11/2018	Date 06/11/2018	Echelle 1/2 - A3
 Fabricant de Fenêtres et Portes.			POSE EN TUNNEL			
			MISE EN OEUVRE	Edition B	Feuille No. PVC 76	

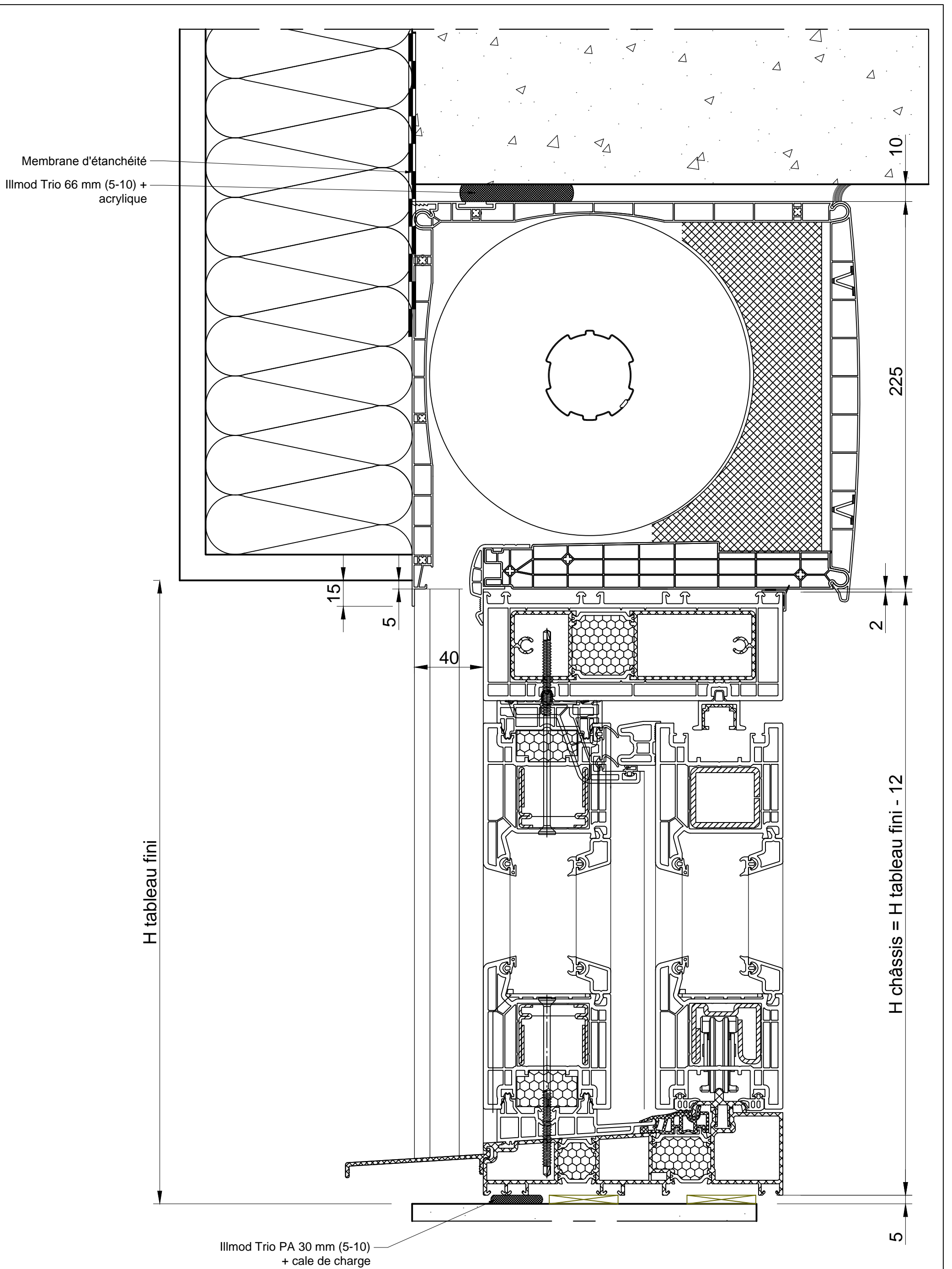

Membrane d'étanchéité
Illmod Trio 66 mm (5-10) +
acrylique

H tableau fini

H châssis = H tableau fini - 12

Illmod Trio PA 30 mm (5-10)
+ cale de charge

CATA TECH	Dessiné par E. TAVARES	Approuvé par N. BUERMANN	Coupe Verticale	Modifié le 26/11/2018	Date 06/11/2018	Echelle 1/2 - A3
 Fabricant de Fenêtres et Portes.			POSE EN TUNNEL (SOFTLINE)			
			MISE EN OEUVRE			Edition B

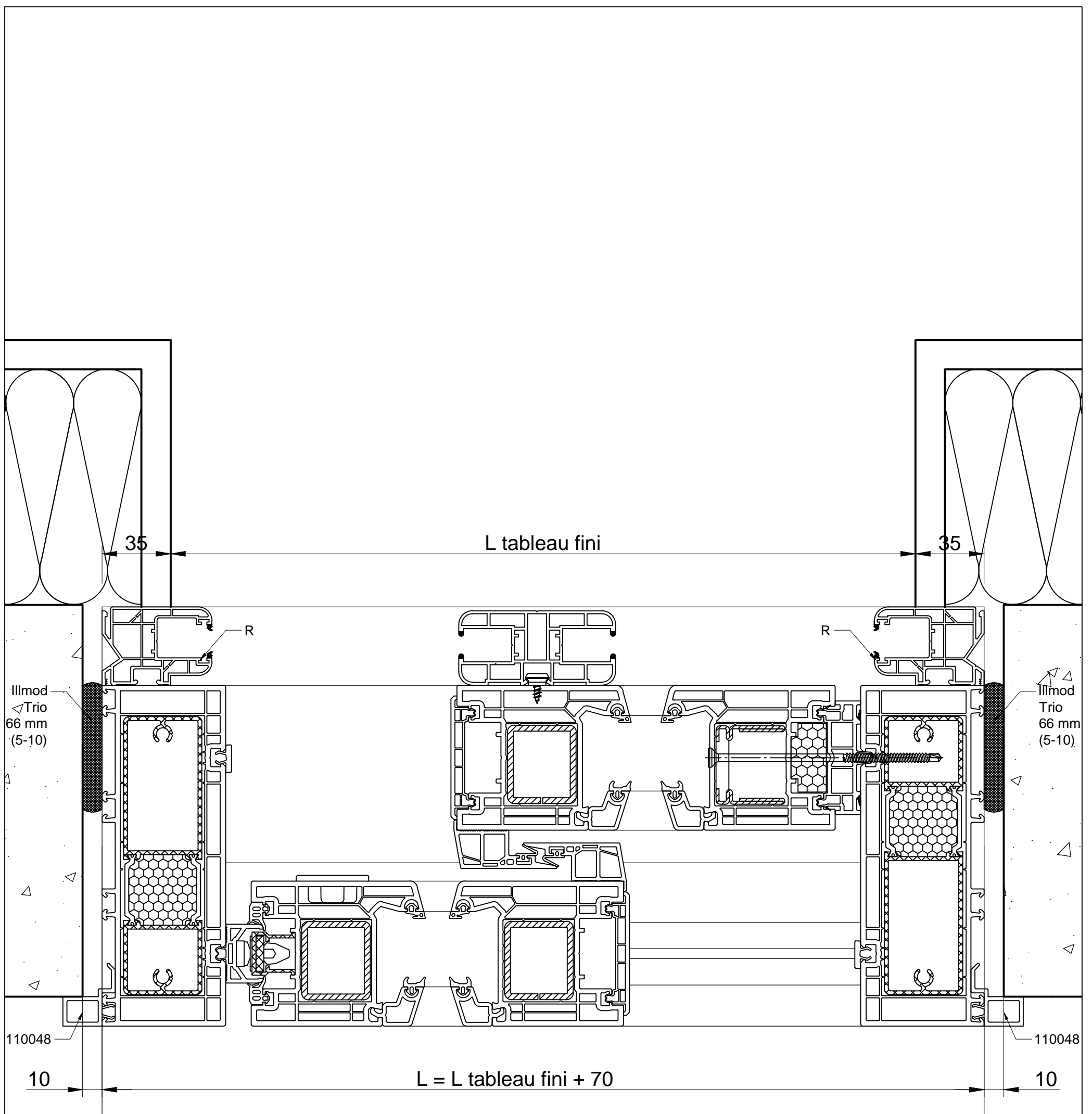

CATA TECH	Dessiné par E. TAVARES	Approuvé par N. BUERMANN	Coupe Verticale	Modifié le 26/11/2018	Date 06/11/2018	Echelle 1/2 - A3
 Fabricant de Fenêtres et Portes.			POSE EN TUNNEL (SOFTLINE)			
			MISE EN OEUVRE	Edition B	Feuille No. PVC 78	

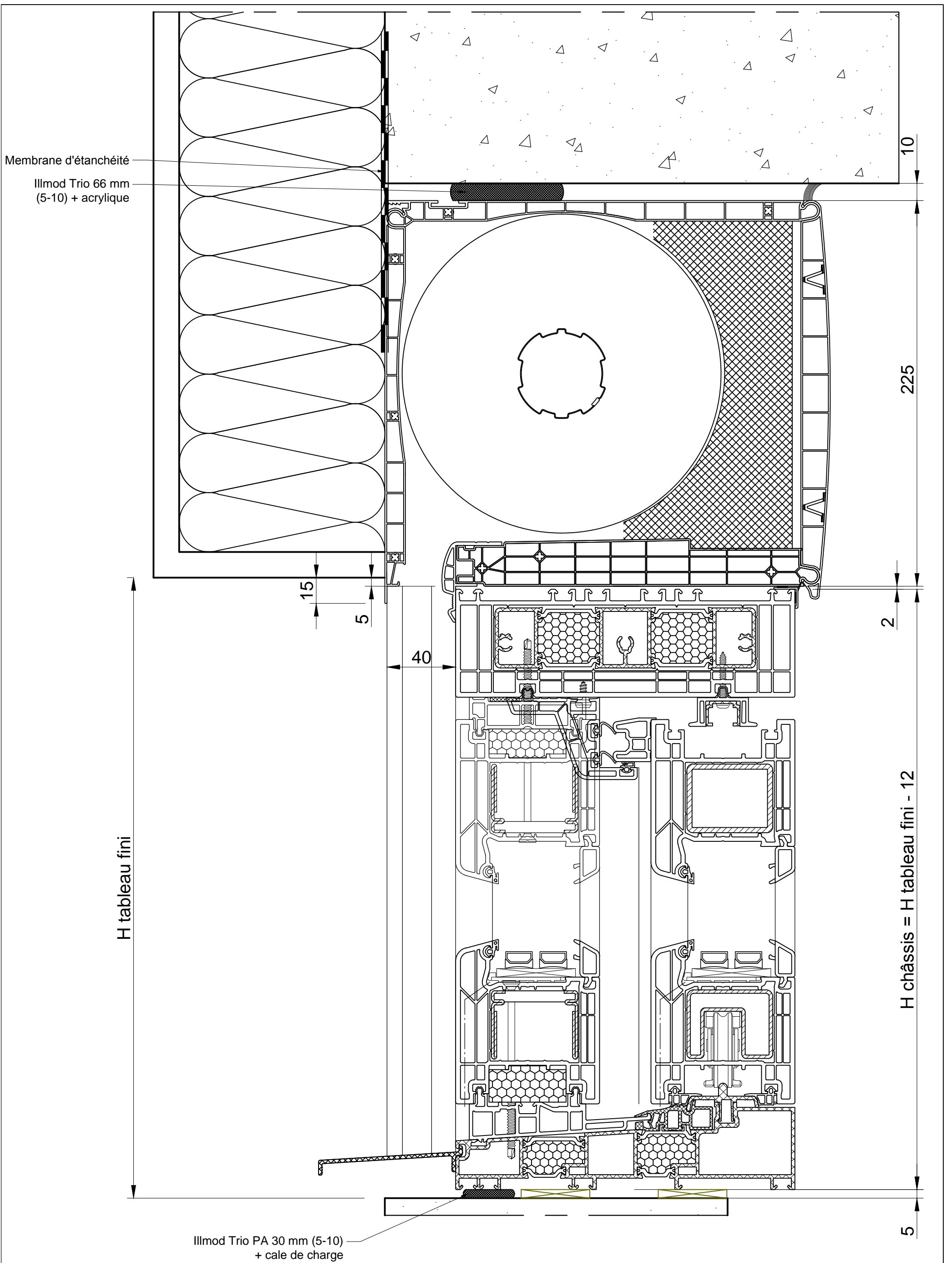

CATA TECH	Dessiné par E. TAVARES	Approuvé par N. BUERMANN	Coupe Verticale	Modifié le 26/11/2018	Date 06/11/2018	Echelle 1/2 - A3
 Fabricant de Fenêtres et Portes.			POSE EN TUNNEL (QUINLINE)			
			MISE EN OEUVRE			Edition B

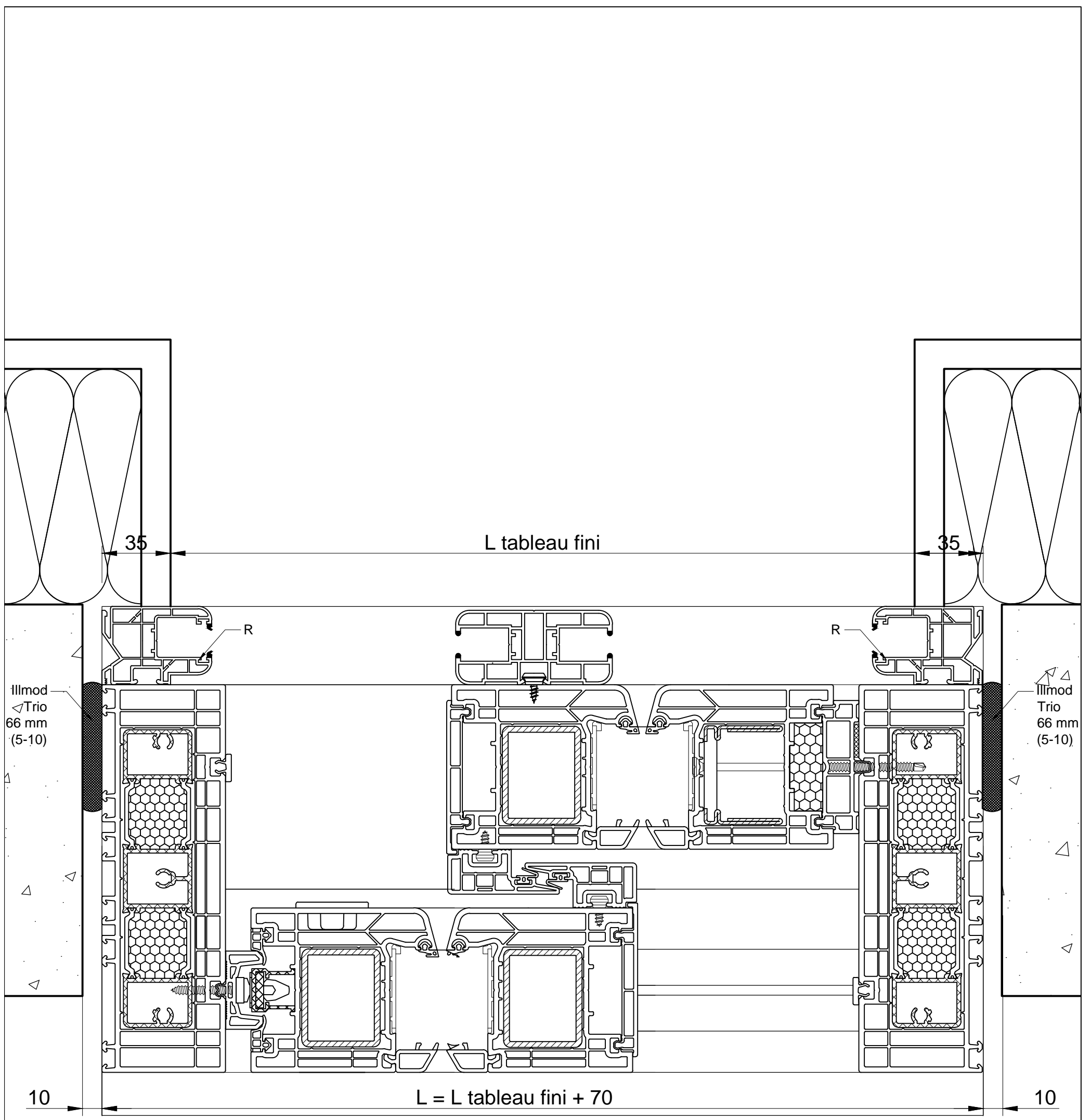

CATA TECH	Dessiné par E. TAVARES	Approuvé par N. BUERMANN	Coupe Verticale	Modifié le 26/11/2018	Date 06/11/2018	Echelle 1/2 - A3
 Fabricant de Fenêtres et Portes.			POSE EN TUNNEL (QUILINE)			
			MISE EN OEUVRE	Edition B	Feuille No. PVC 80	

COULISSE MONO 0° : M0

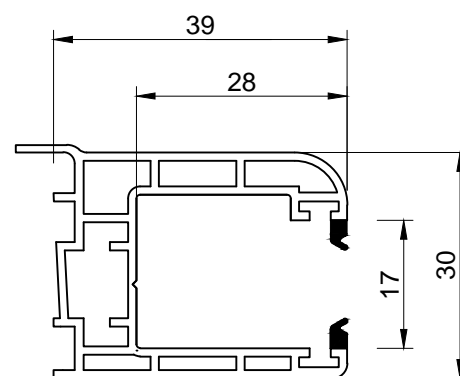

COULISSE MONO 3° : M3

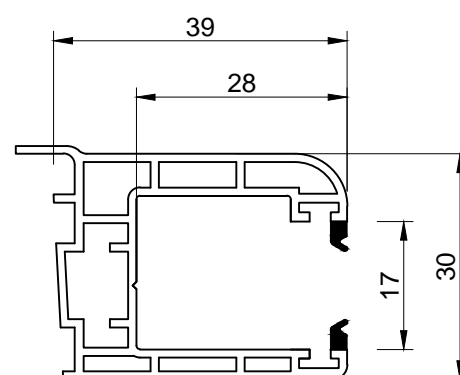

COULISSE RENOVATION : R

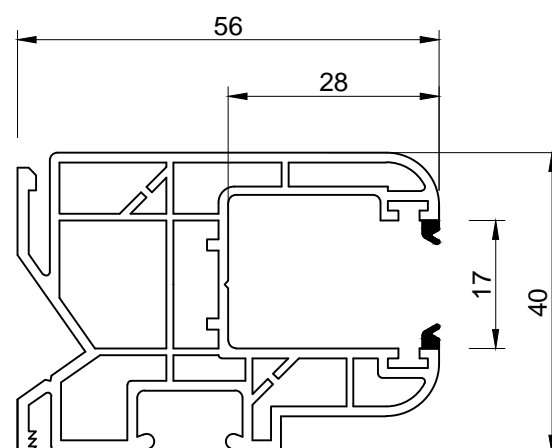



CATA TECH	Dessiné par E. TAVARES	Approuvé par N. BUERMANN	Coupe Verticale	Modifié le 26/11/2018	Date 06/11/2018	Echelle 1/1 - A3
 Fabricant de Fenêtres et Portes.			COULISSES PVC			
			MISE EN OEUVRE			Edition B

3

Mise en Oeuvre

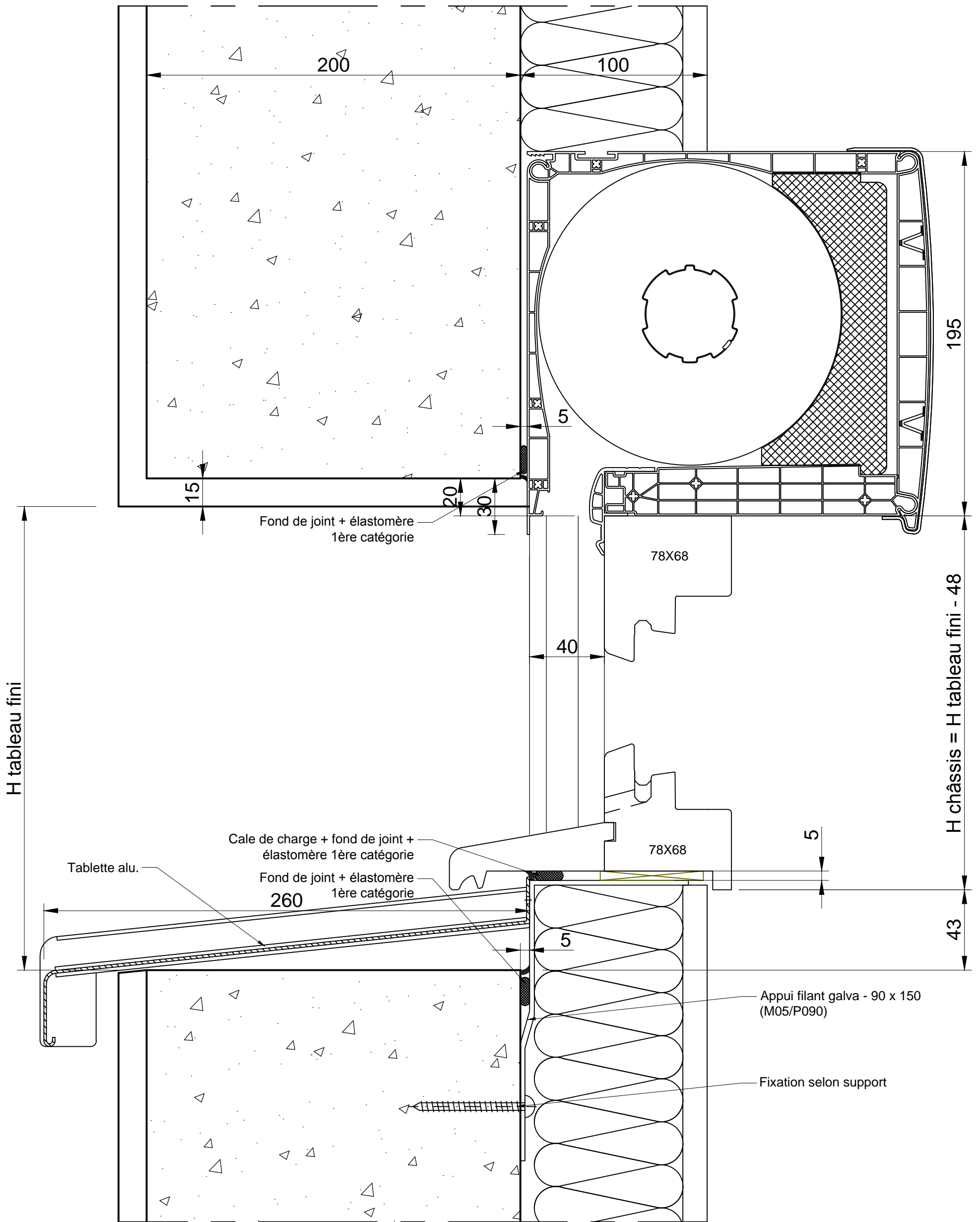
Thermobloc - BOIS / BOIS-ALU



CATA TECH	Dessiné par E. TAVARES	Approuvé par -	Coupe Verticale	Modifié le 08/12/2020	Date 15/07/2020	Echelle 1/2 - A3
 Fabricant de Fenêtres et Portes.			APPLIQUE RATTRAPAGE ISO 100			
			MISE EN OEUVRE			Edition E

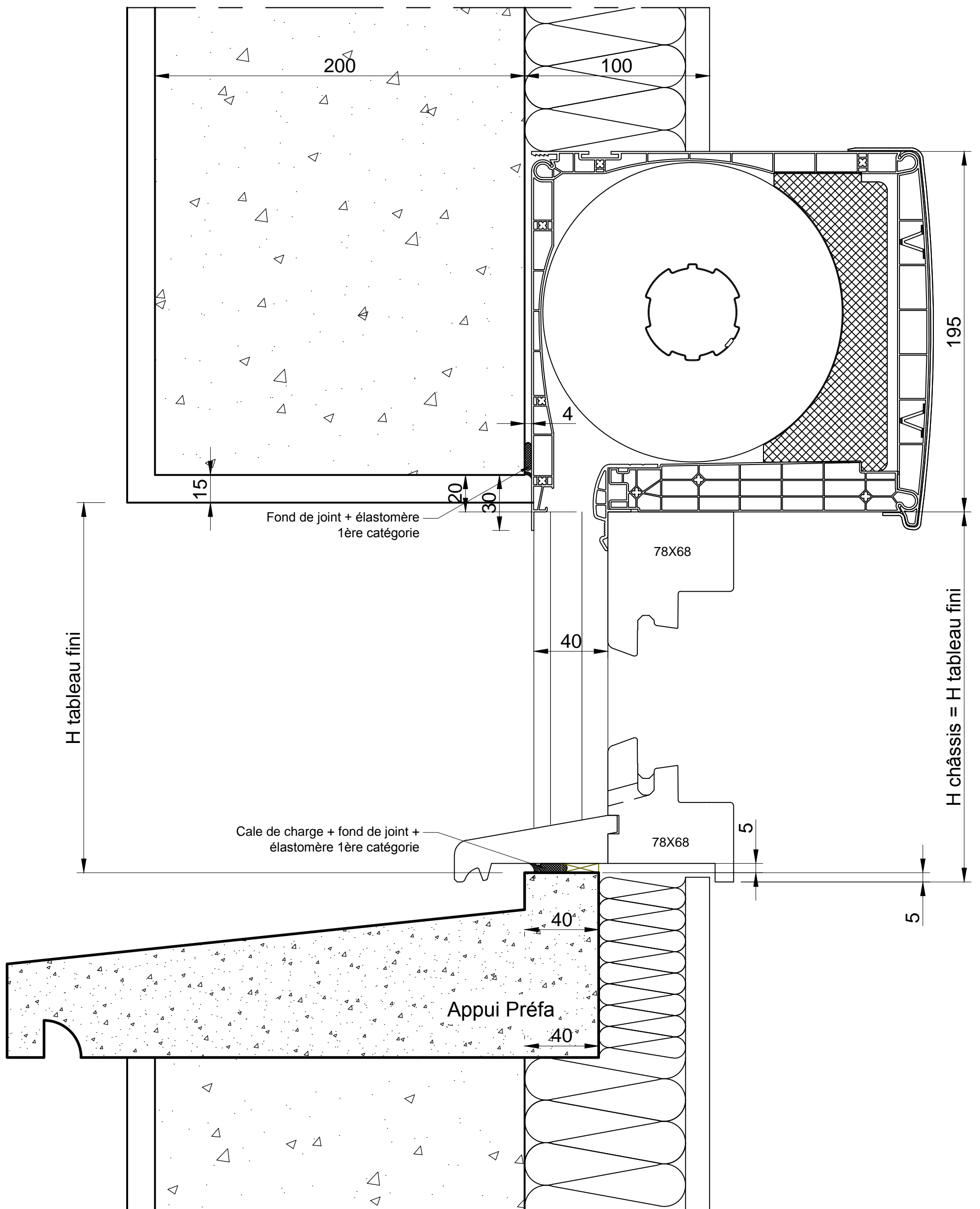

CATA TECH	Dessiné par E. TAVARES	Approuvé par -	Coupe Verticale	Modifié le 08/12/2020	Date 15/07/2020	Echelle 1/2 - A3
 <p>hilzinger Fabricant de Fenêtres et Portes.</p>			APPLIQUE RATRAPAGE ISO 100			
			MISE EN OEUVRE			Edition E

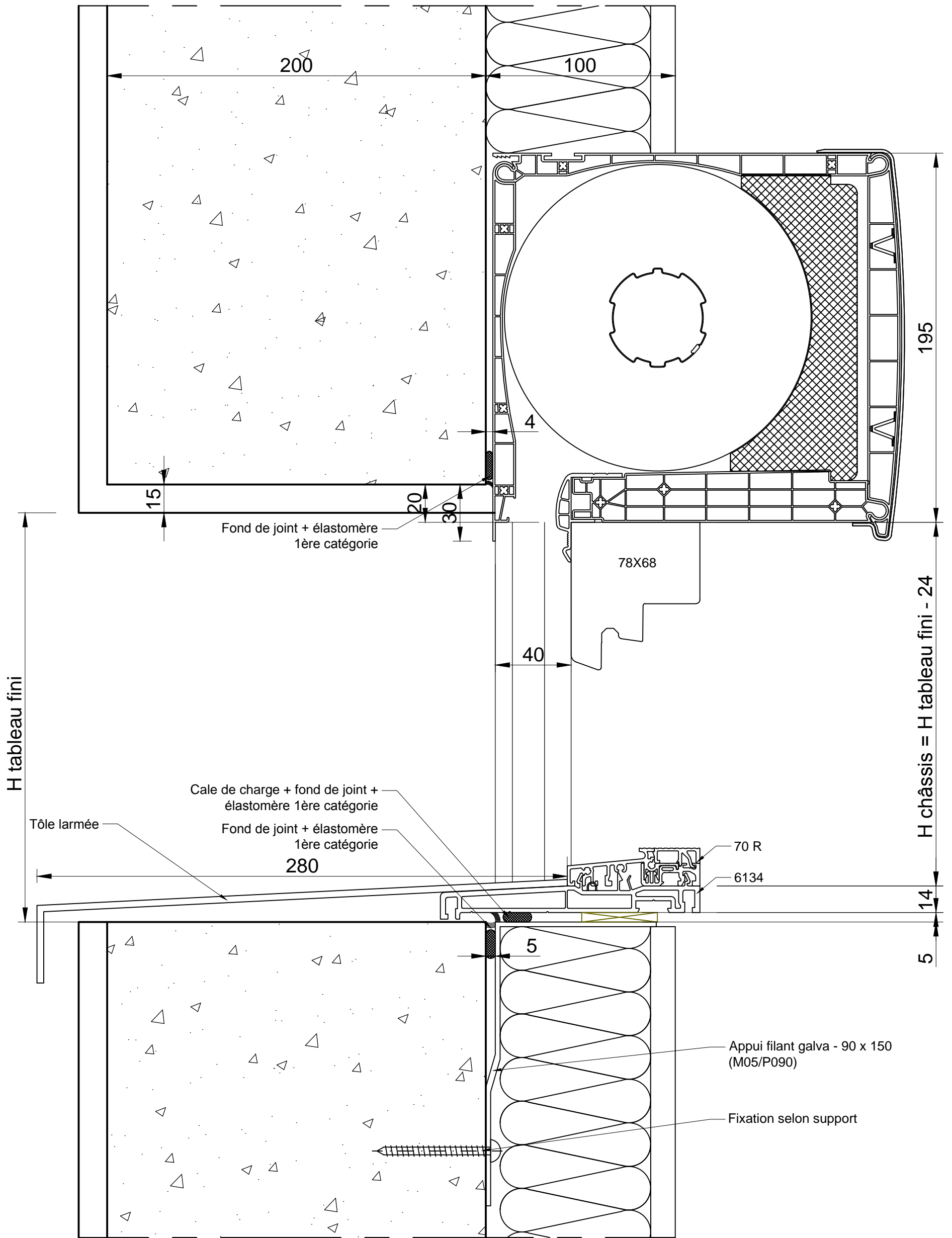

CATA TECH	Dessiné par E. TAVARES	Approuvé par -	Coupe Verticale	Modifié le 08/12/2020	Date 15/07/2020	Echelle 1/2 - A3
 Fabricant de Fenêtres et Portes.			APPLIQUE RATTRAPAGE ISO 100			
			MISE EN OEUVRE			Edition E

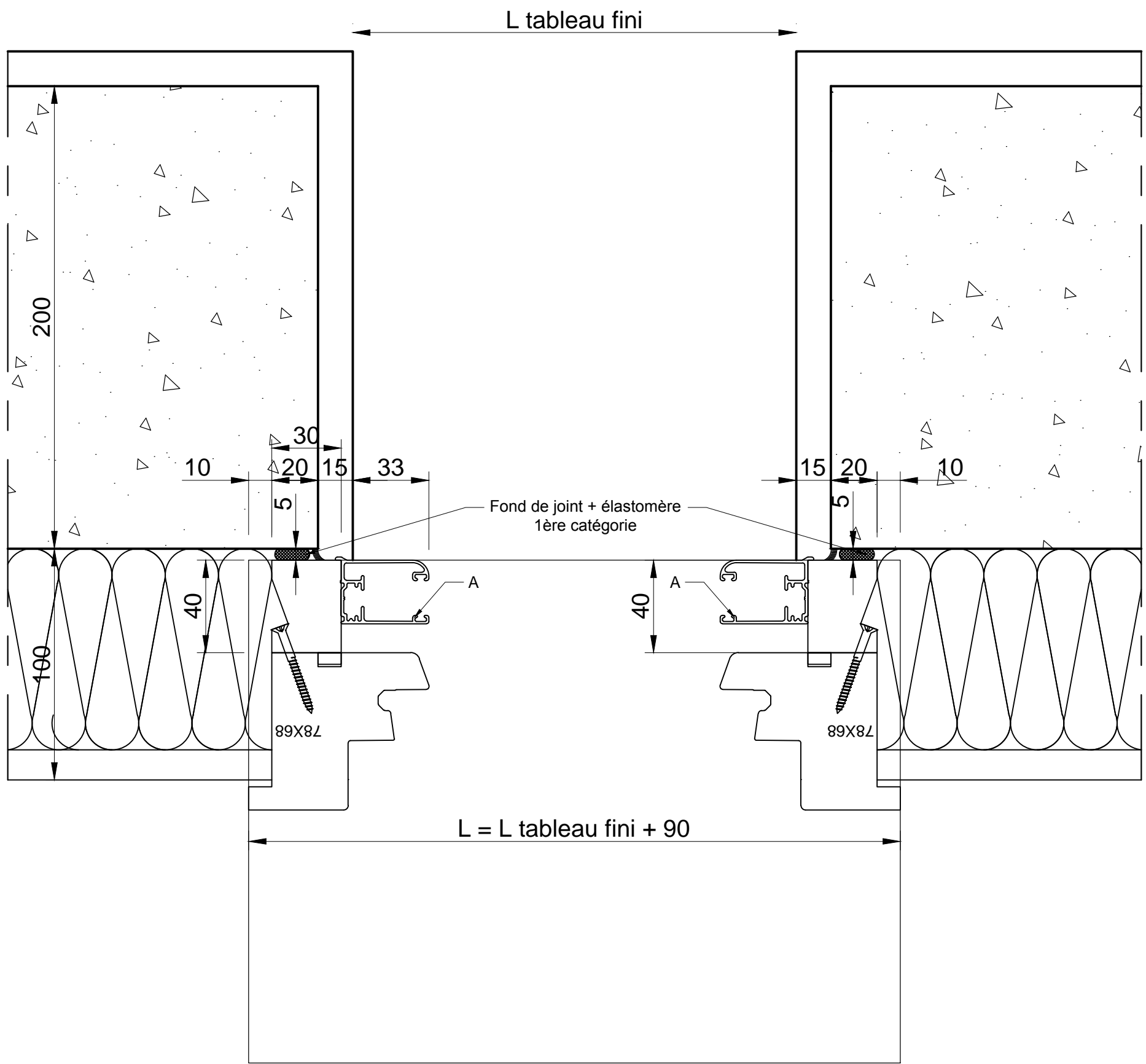

CATA TECH	Dessiné par E. TAVARES	Approuvé par -	Coupe Verticale	Modifié le 08/12/2020	Date 15/07/2020	Echelle 1/2 - A3
 Fabricant de Fenêtres et Portes.			APPLIQUE RATTRAPAGE ISO 100			
			MISE EN OEUVRE			Edition E

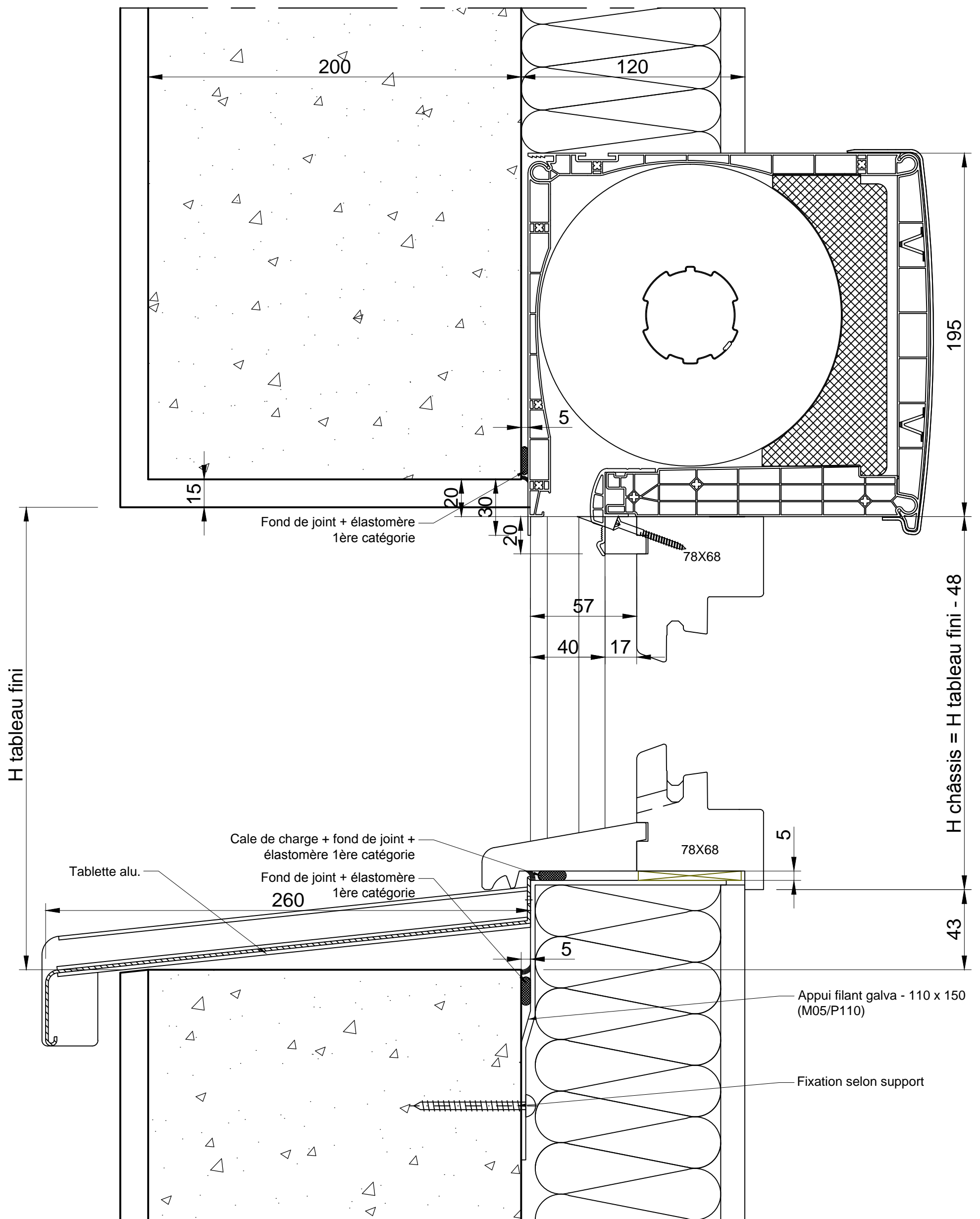

CATA TECH	Dessiné par E. TAVARES	Approuvé par -	Coupe Verticale	Modifié le 08/12/2020	Date 15/07/2020	Echelle 1/2 - A3
 Fabricant de Fenêtres et Portes.			APPLIQUE RATTRAPAGE ISO 120			
			MISE EN OEUVRE		Edition E	Feuille No. BOIS 5

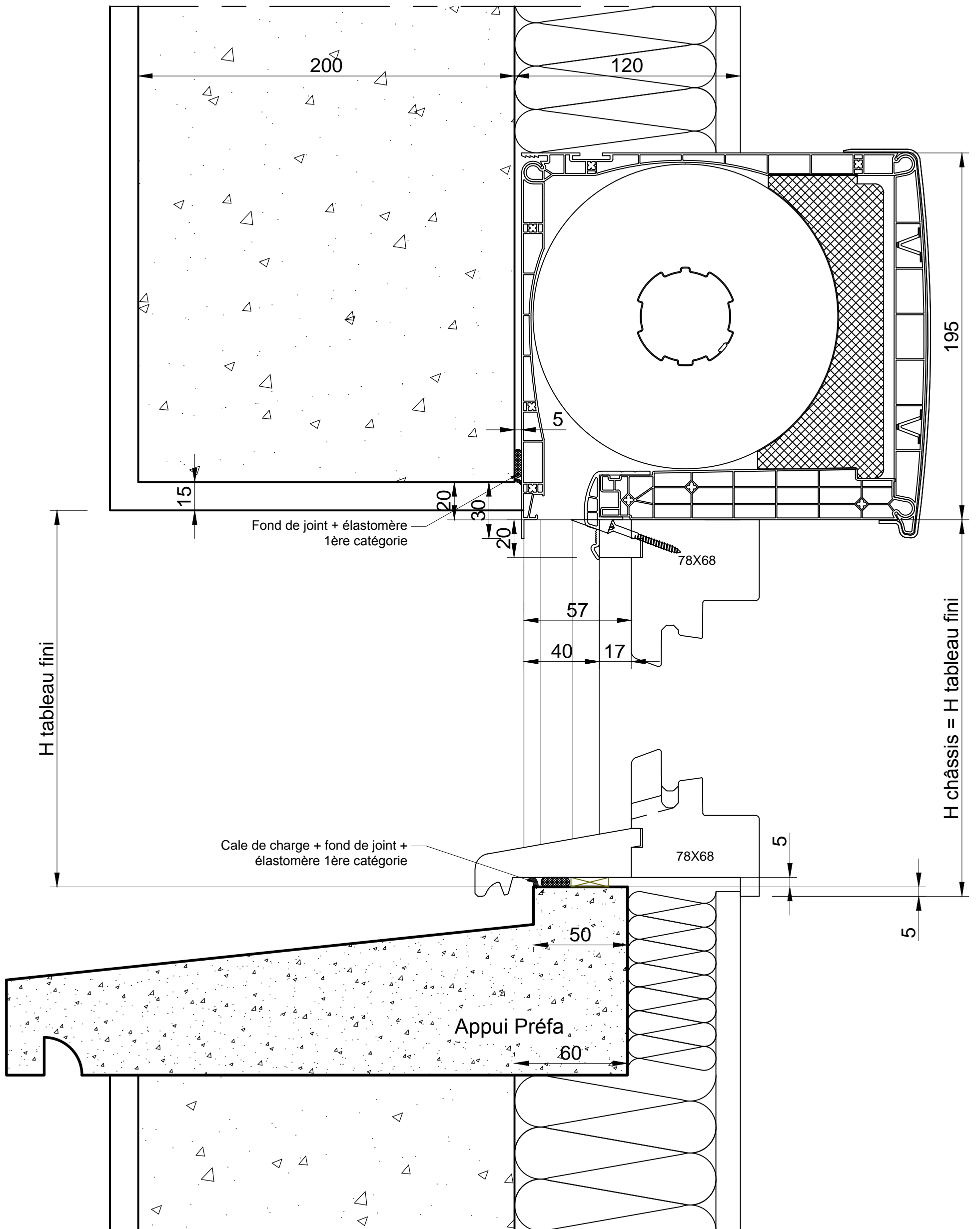

CATA TECH	Dessiné par E. TAVARES	Approuvé par -	Coupe Verticale	Modifié le 08/12/2020	Date 15/07/2020	Echelle 1/2 - A3
 Fabricant de Fenêtres et Portes.			APPLIQUE RATTRAPAGE ISO 120			
			MISE EN OEUVRE			Edition E

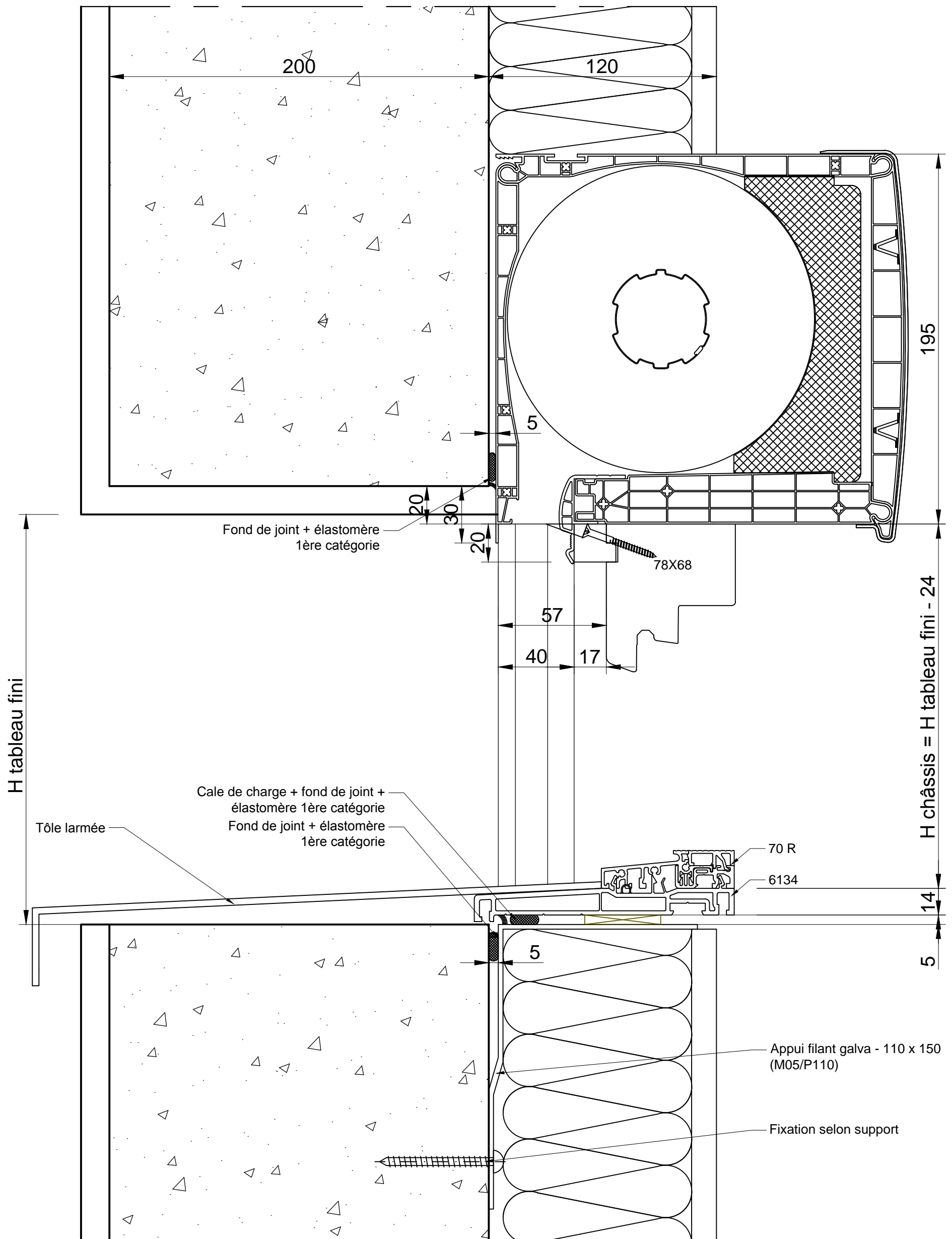

CATA TECH	Dessiné par E. TAVARES	Approuvé par -	Coupe Verticale	Modifié le 08/12/2020	Date 15/07/2020	Echelle 1/2 - A3
 <p>Fabricant de Fenêtres et Portes.</p>			APPLIQUE RATTRAPAGE ISO 120			
			MISE EN OEUVRE			Edition E

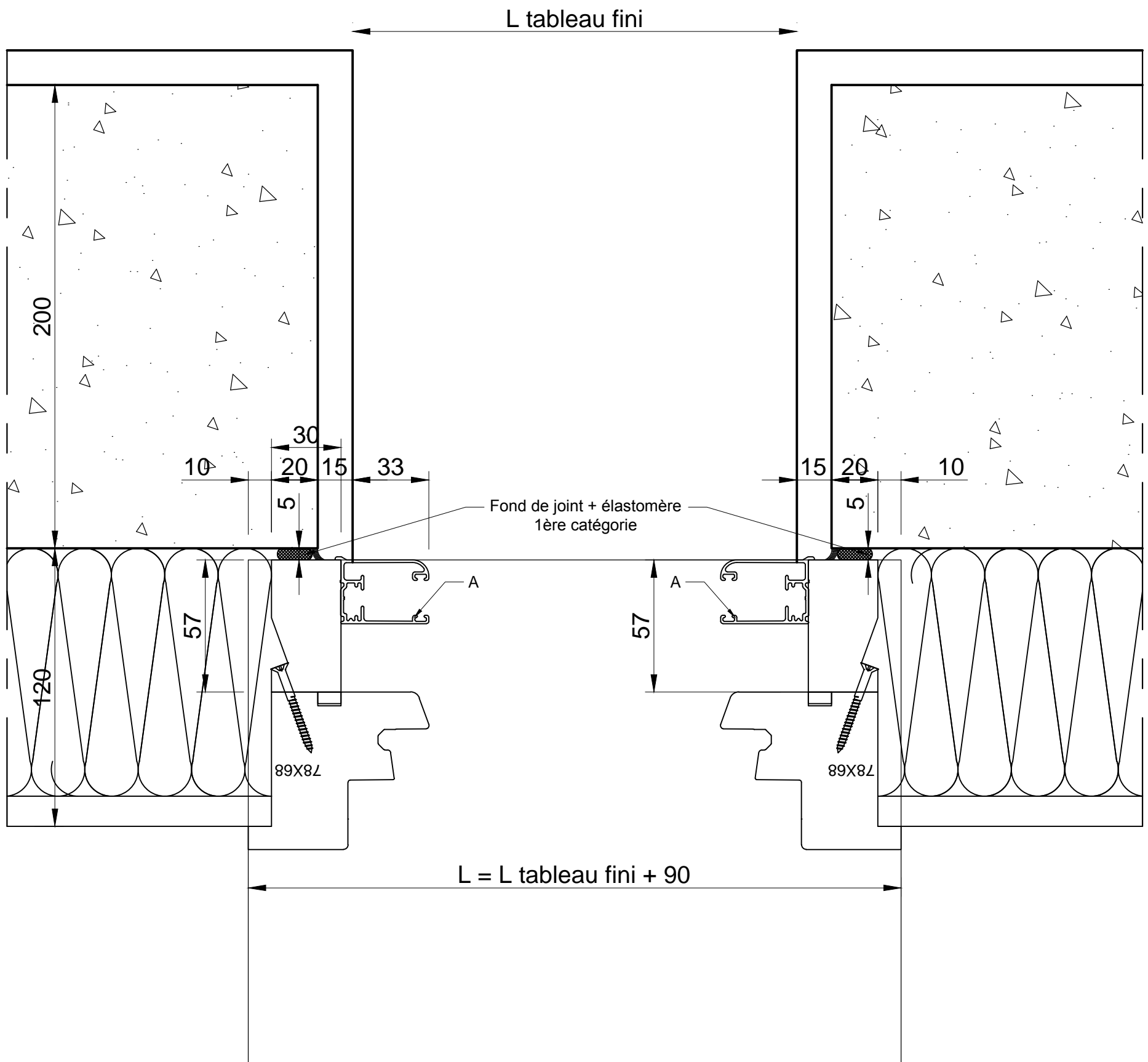

CATA TECH	Dessiné par E. TAVARES	Approuvé par -	Coupe Verticale	Modifié le 08/12/2020	Date 15/07/2020	Echelle 1/2 - A3
 Fabricant de Fenêtres et Portes.			APPLIQUE RATRAPAGE ISO 120			
			MISE EN OEUVRE			Edition E

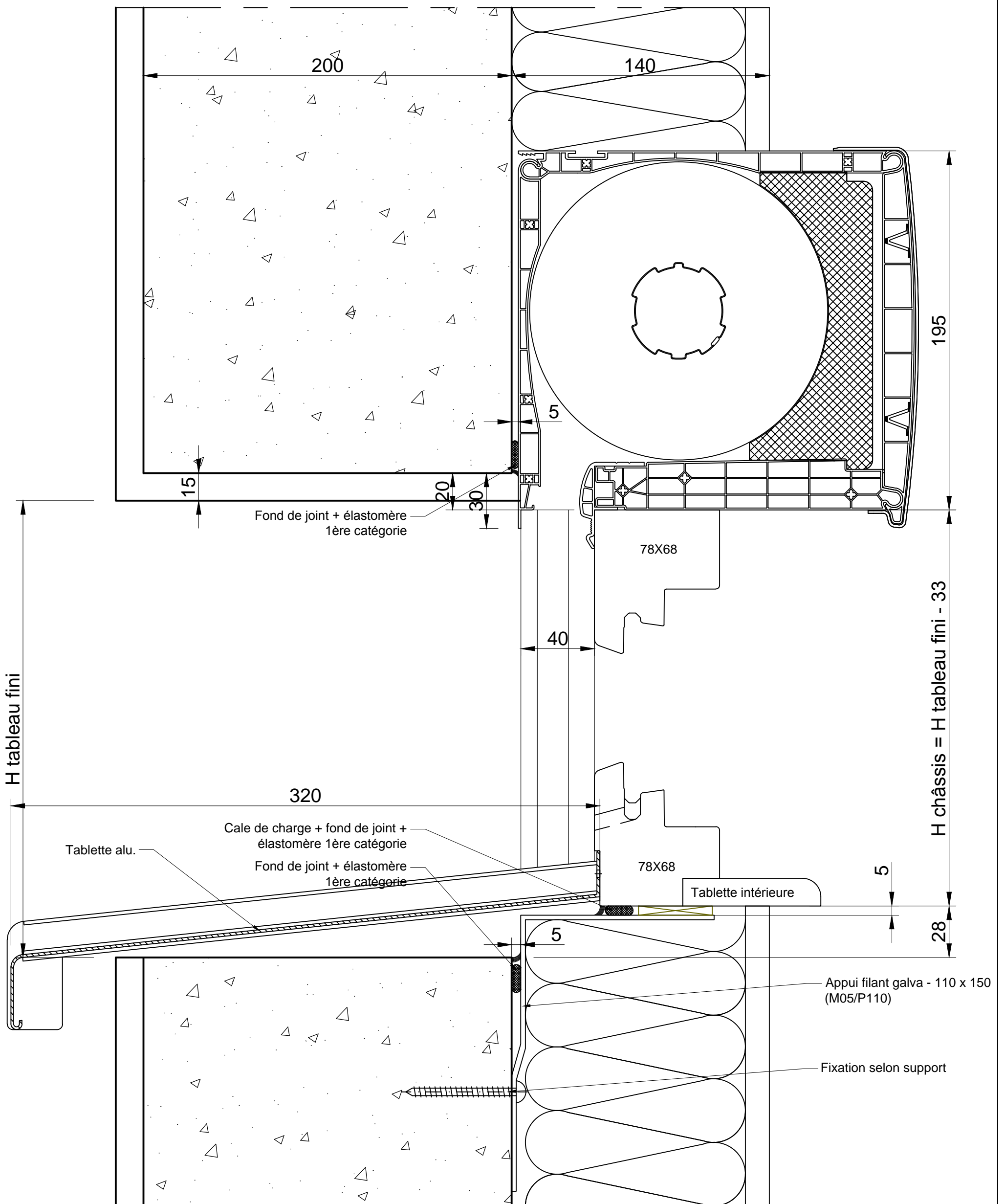

CATA TECH	Dessiné par E. TAVARES	Approuvé par -	Coupe Verticale	Modifié le 08/12/2020	Date 15/07/2020	Echelle 1/2 - A3
 <p>hilzinger Fabricant de Fenêtres et Portes.</p>			APPLIQUE RATTRAPAGE ISO 140			
			MISE EN OEUVRE			Edition E

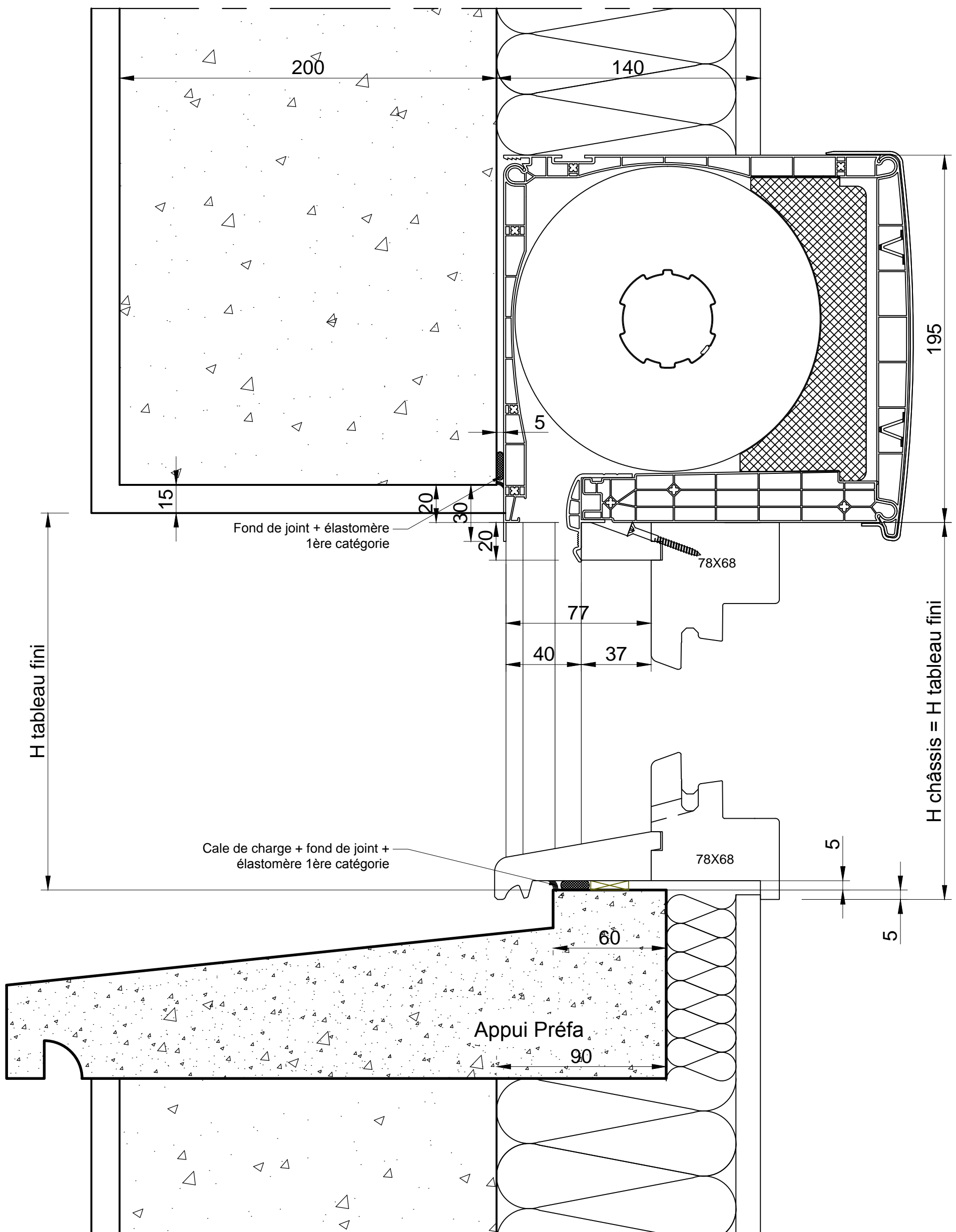

CATA TECH	Dessiné par E. TAVARES	Approuvé par -	Coupe Verticale	Modifié le 08/12/2020	Date 15/07/2020	Echelle 1/2 - A3
 <p>hilzinger Fabricant de Fenêtres et Portes.</p>			APPLIQUE RATRAPAGE ISO 140			
			MISE EN OEUVRE			Edition E

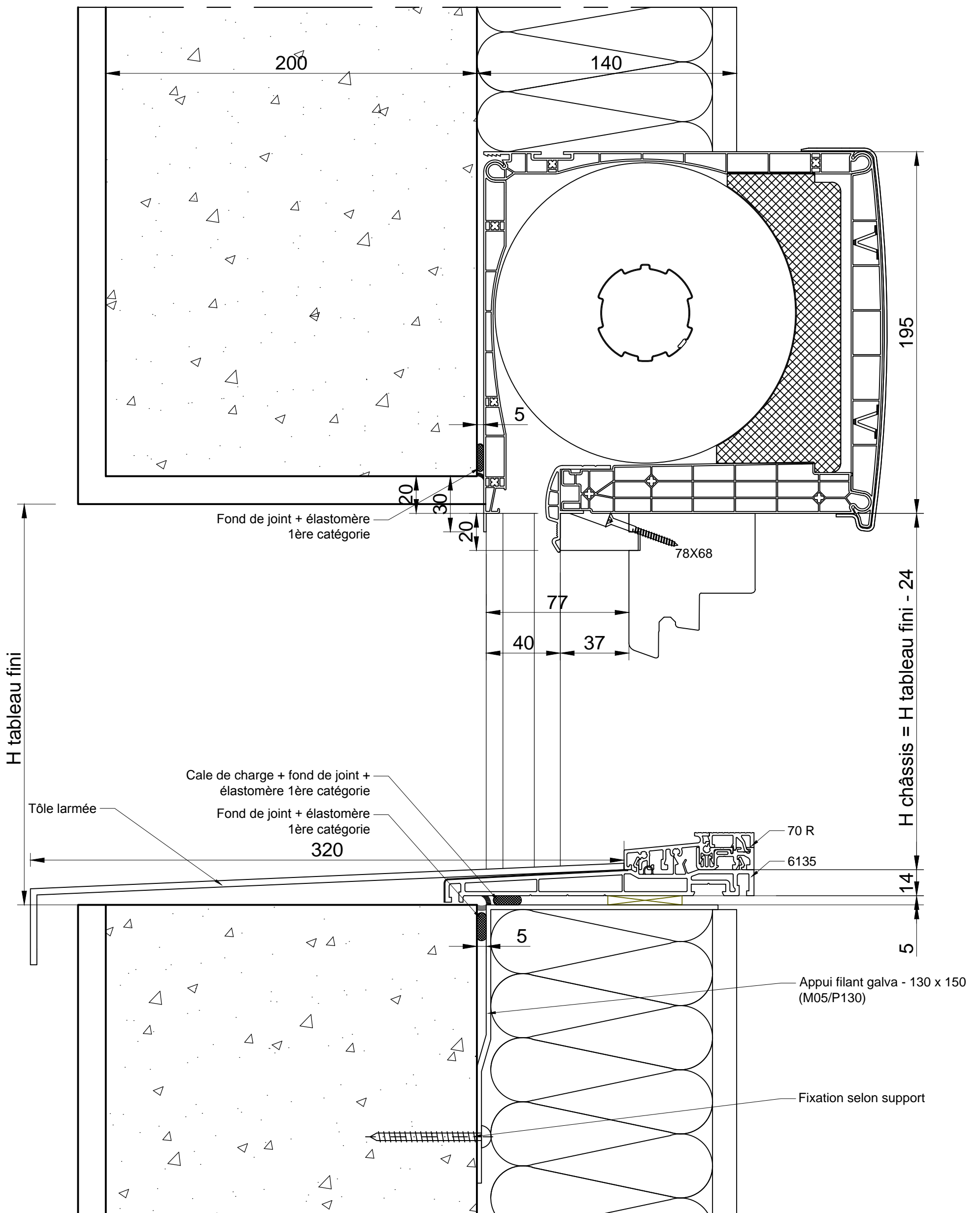

CATA TECH	Dessiné par E. TAVARES	Approuvé par -	Coupe Verticale	Modifié le 08/12/2020	Date 15/07/2020	Echelle 1/2 - A3
 <p>hilzinger Fabricant de Fenêtres et Portes.</p>			APPLIQUE RATTRAPAGE ISO 140			
			MISE EN OEUVRE			Edition E

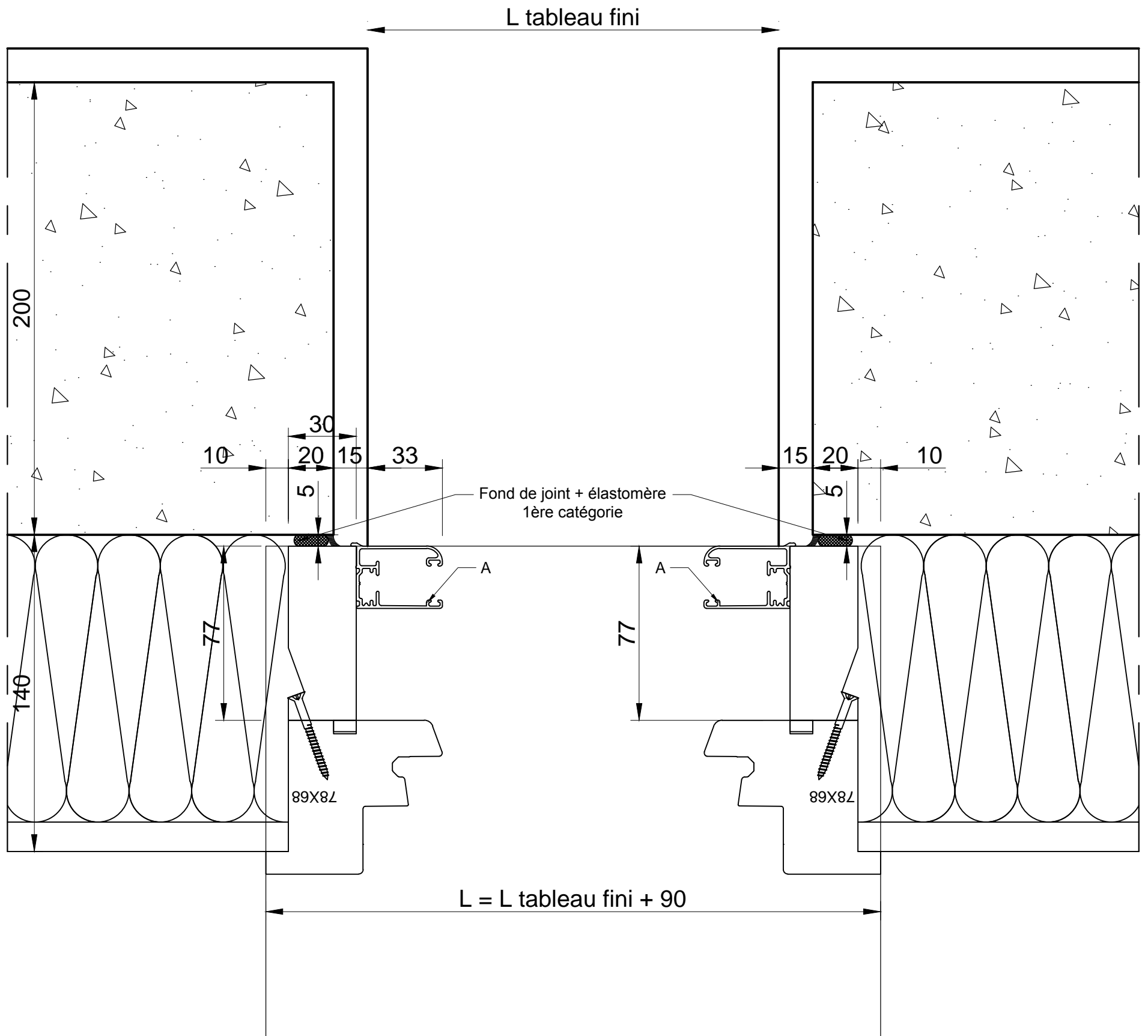

CATA TECH	Dessiné par E. TAVARES	Approuvé par -	Coupe Verticale	Modifié le 08/12/2020	Date 15/07/2020	Echelle 1/2 - A3
 Fabricant de Fenêtres et Portes.			APPLIQUE RATTRAPAGE ISO 140			
			MISE EN OEUVRE			Edition E

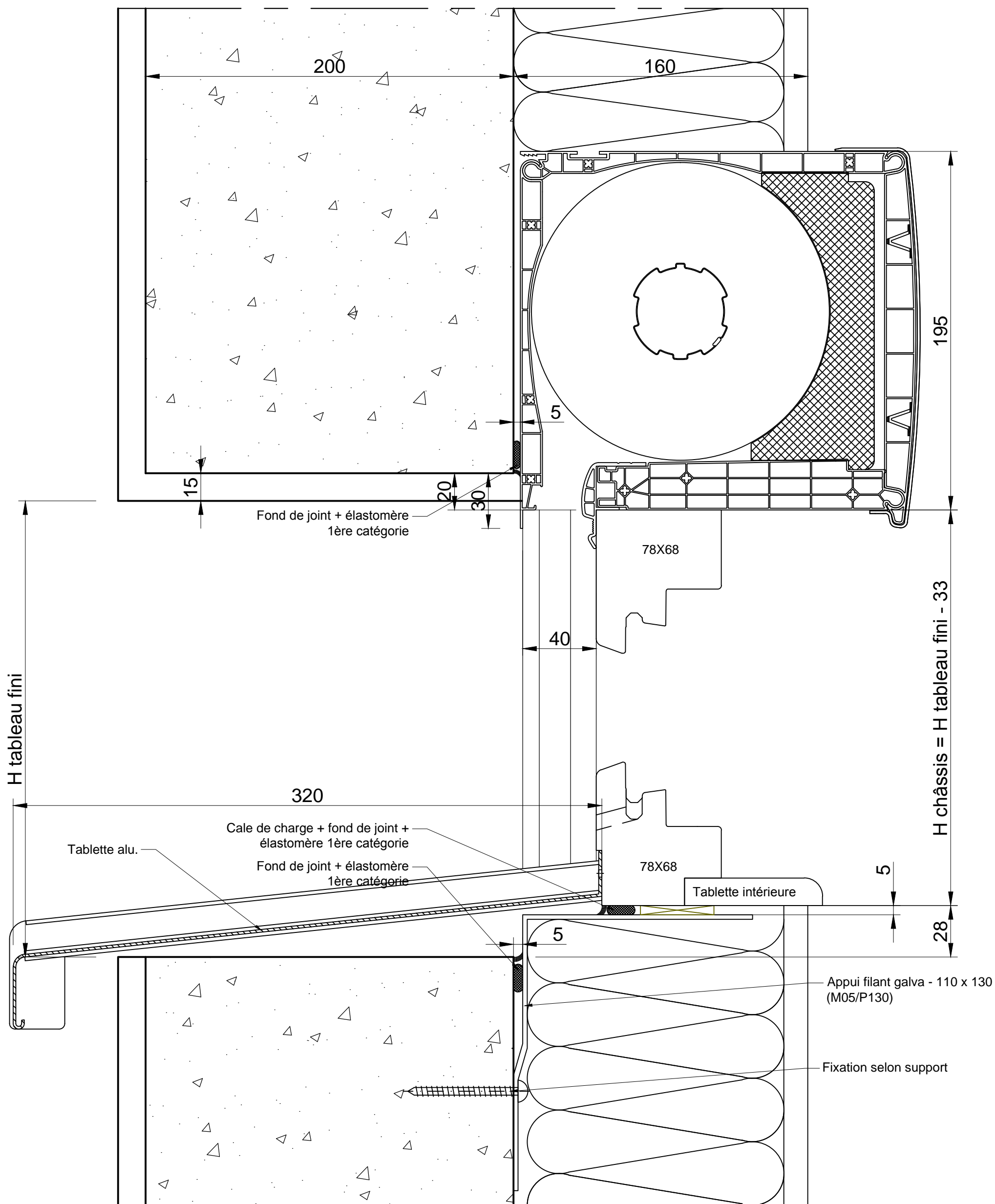

CATA TECH	Dessiné par E. TAVARES	Approuvé par -	Coupe Verticale	Modifié le 08/12/2020	Date 15/07/2020	Echelle 1/2 - A3
 Fabricant de Fenêtres et Portes.			APPLIQUE RATTRAPAGE ISO 160			
			MISE EN OEUVRE			Edition E

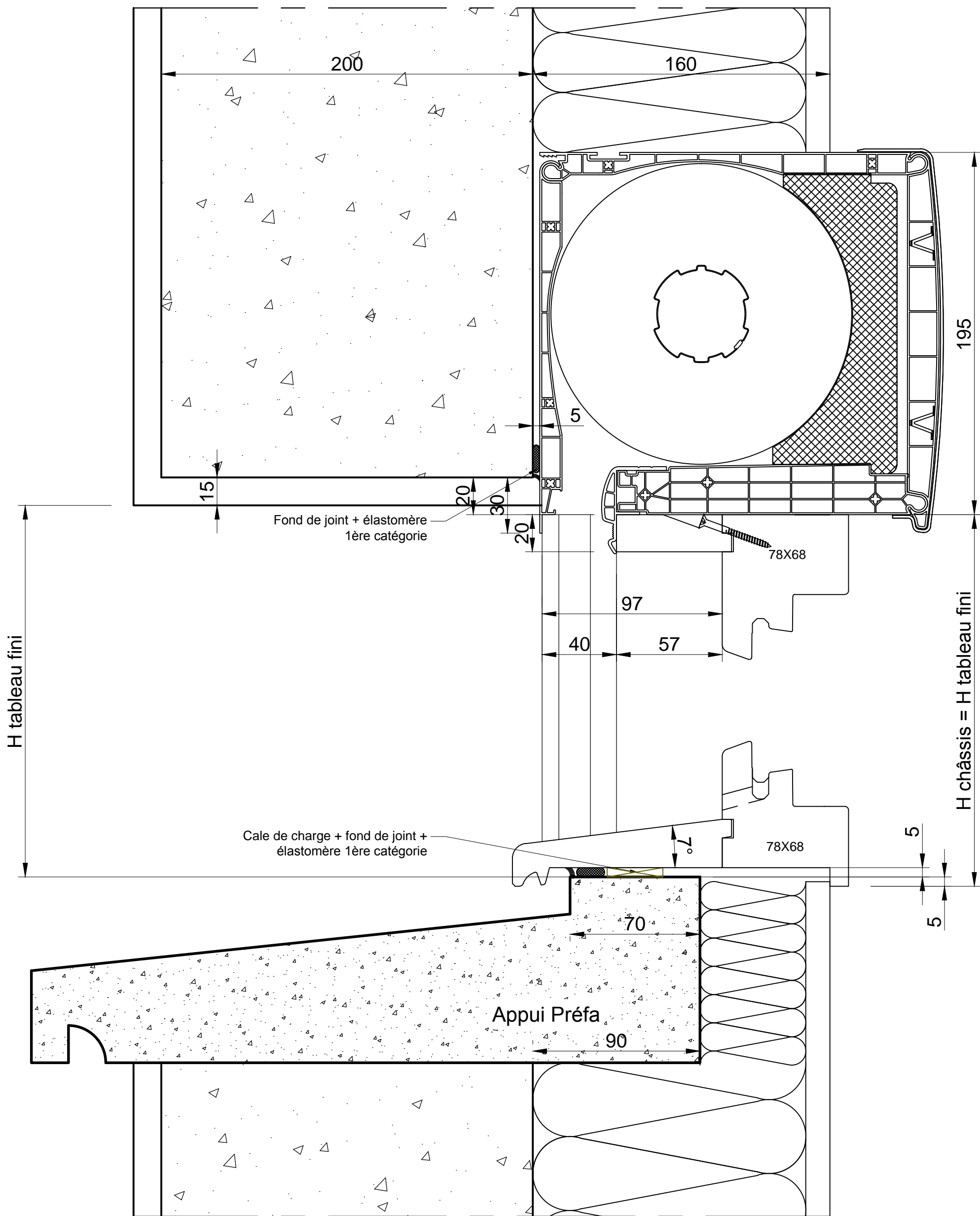

CATA TECH	Dessiné par E. TAVARES	Approuvé par -	Coupe Verticale	Modifié le 08/12/2020	Date 15/07/2020	Echelle 1/2 - A3
 Fabricant de Fenêtres et Portes.			APPLIQUE RATTRAPAGE ISO 160			
			MISE EN OEUVRE			Edition E

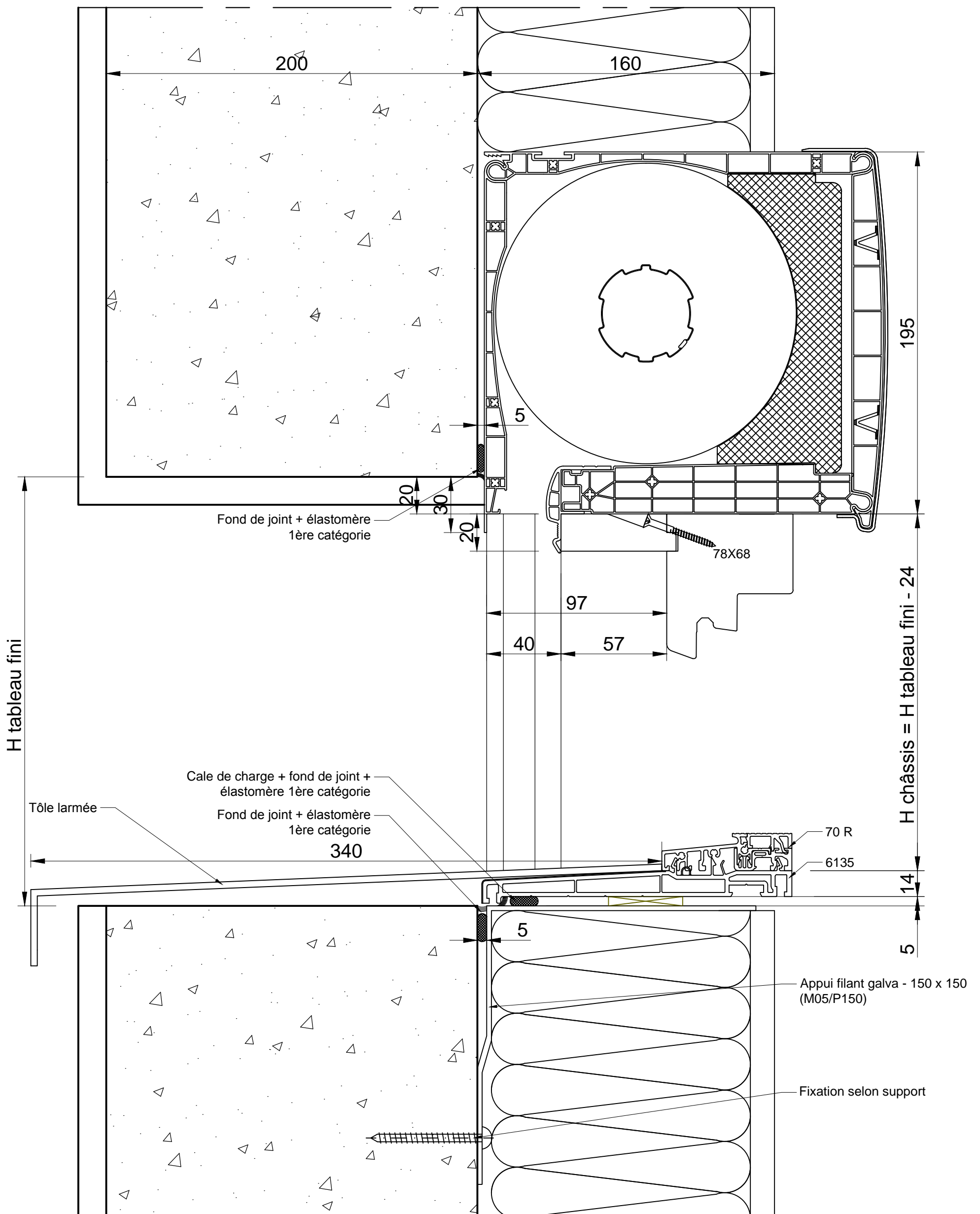

CATA TECH	Dessiné par E. TAVARES	Approuvé par -	Coupe Verticale	Modifié le 08/12/2020	Date 15/07/2020	Echelle 1/2 - A3
 Fabricant de Fenêtres et Portes.			APPLIQUE RATTRAPAGE ISO 160			
			MISE EN OEUVRE			Edition E

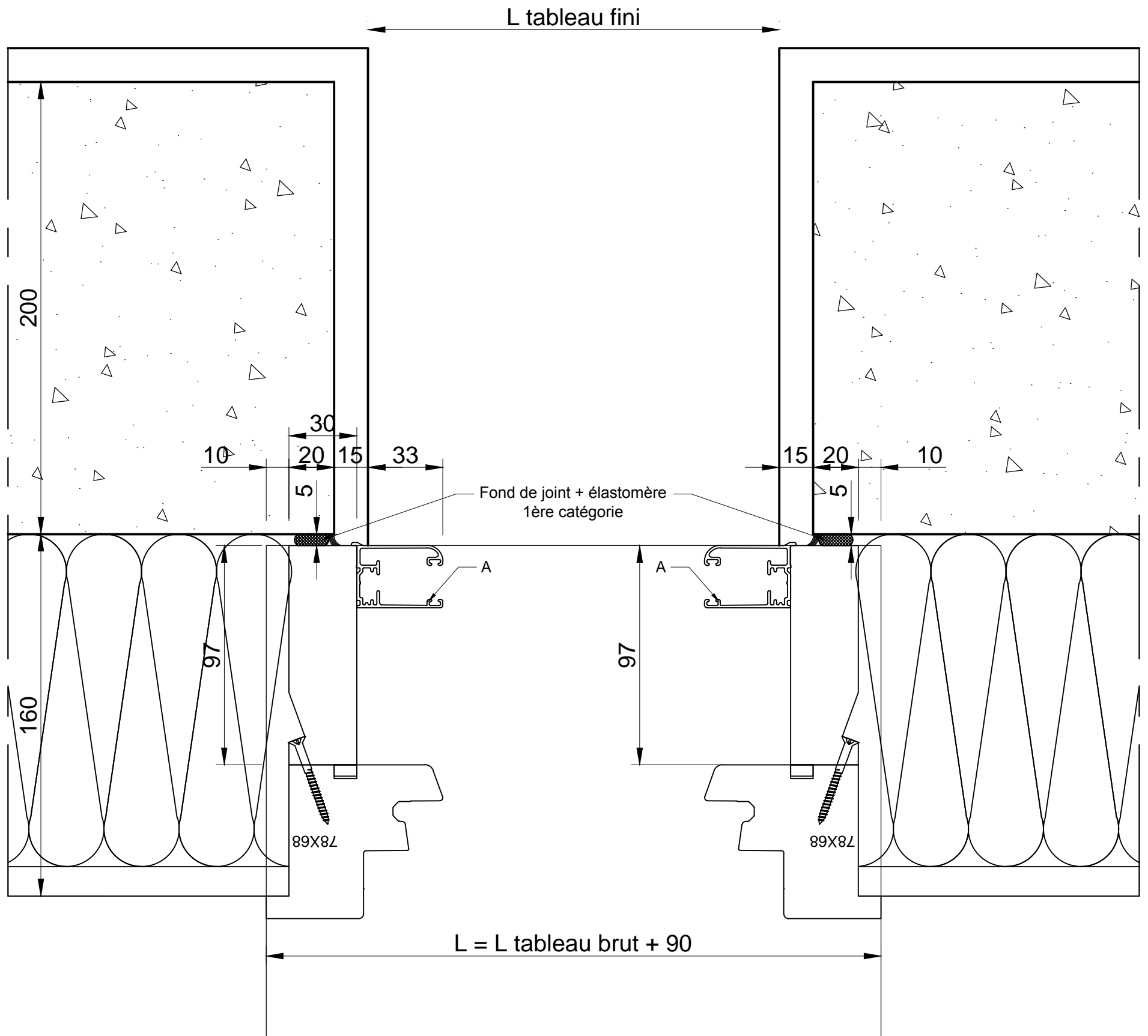

CATA TECH	Dessiné par E. TAVARES	Approuvé par -	Coupe Verticale	Modifié le 08/12/2020	Date 15/07/2020	Echelle 1/2 - A3
 Fabricant de Fenêtres et Portes.			APPLIQUE RATRAPAGE ISO 160			
			MISE EN OEUVRE		Edition E	Feuille No. BOIS 16

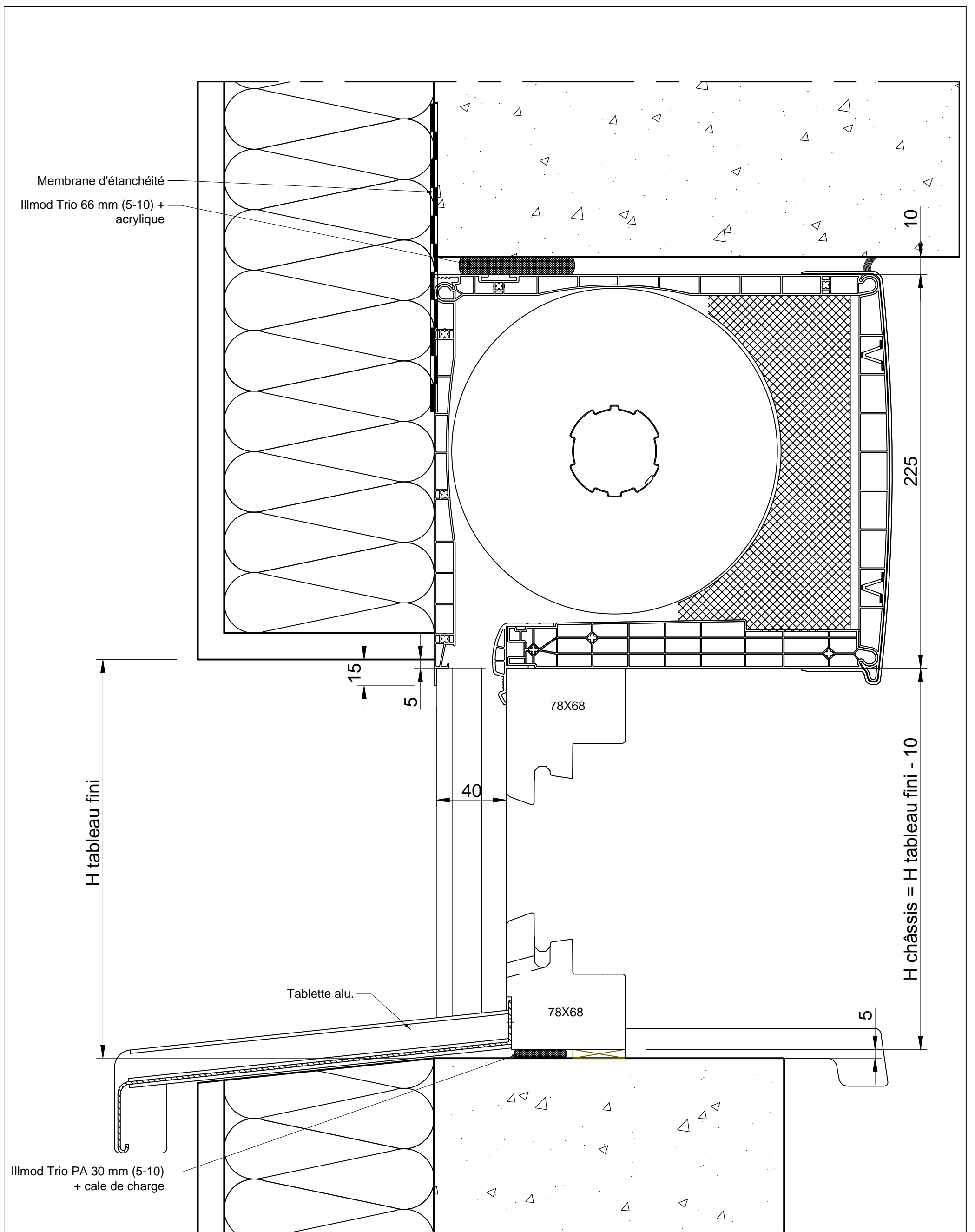

CATA TECH	Dessiné par E. TAVARES	Approuvé par -	Coupe Verticale	Modifié le 08/12/2020	Date 15/07/2020	Echelle 1/2 - A3
 Fabricant de Fenêtres et Portes.			POSE EN TUNNEL			
			MISE EN OEUVRE	Edition E	Feuille No. BOIS 17	

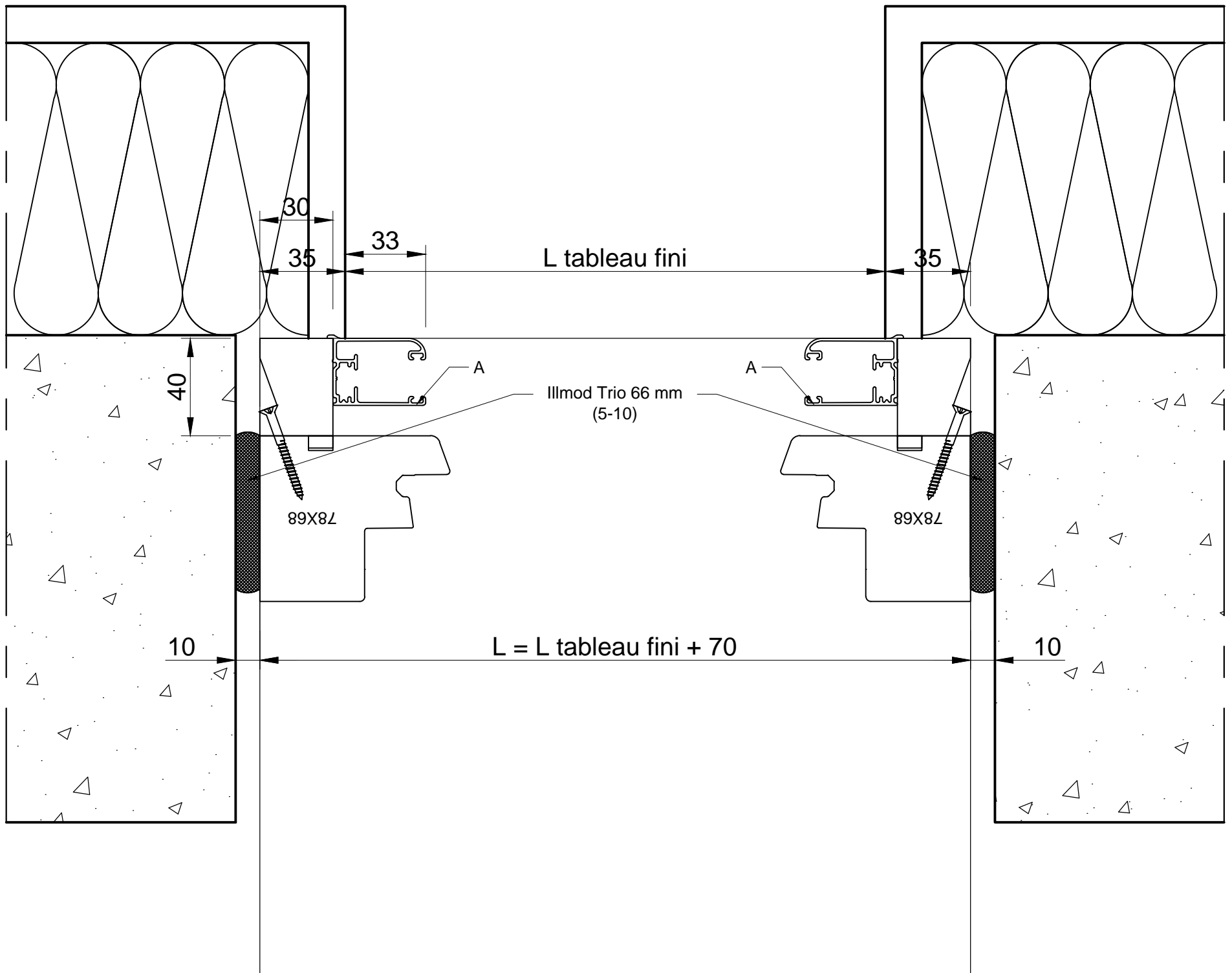

CATA TECH	Dessiné par E. TAVARES	Approuvé par -	Coupe Verticale	Modifié le 08/12/2020	Date 15/07/2020	Echelle 1/2 - A3
 Fabricant de Fenêtres et Portes.			POSE EN TUNNEL			
			MISE EN OEUVRE	Edition E	Feuille No. BOIS 18	

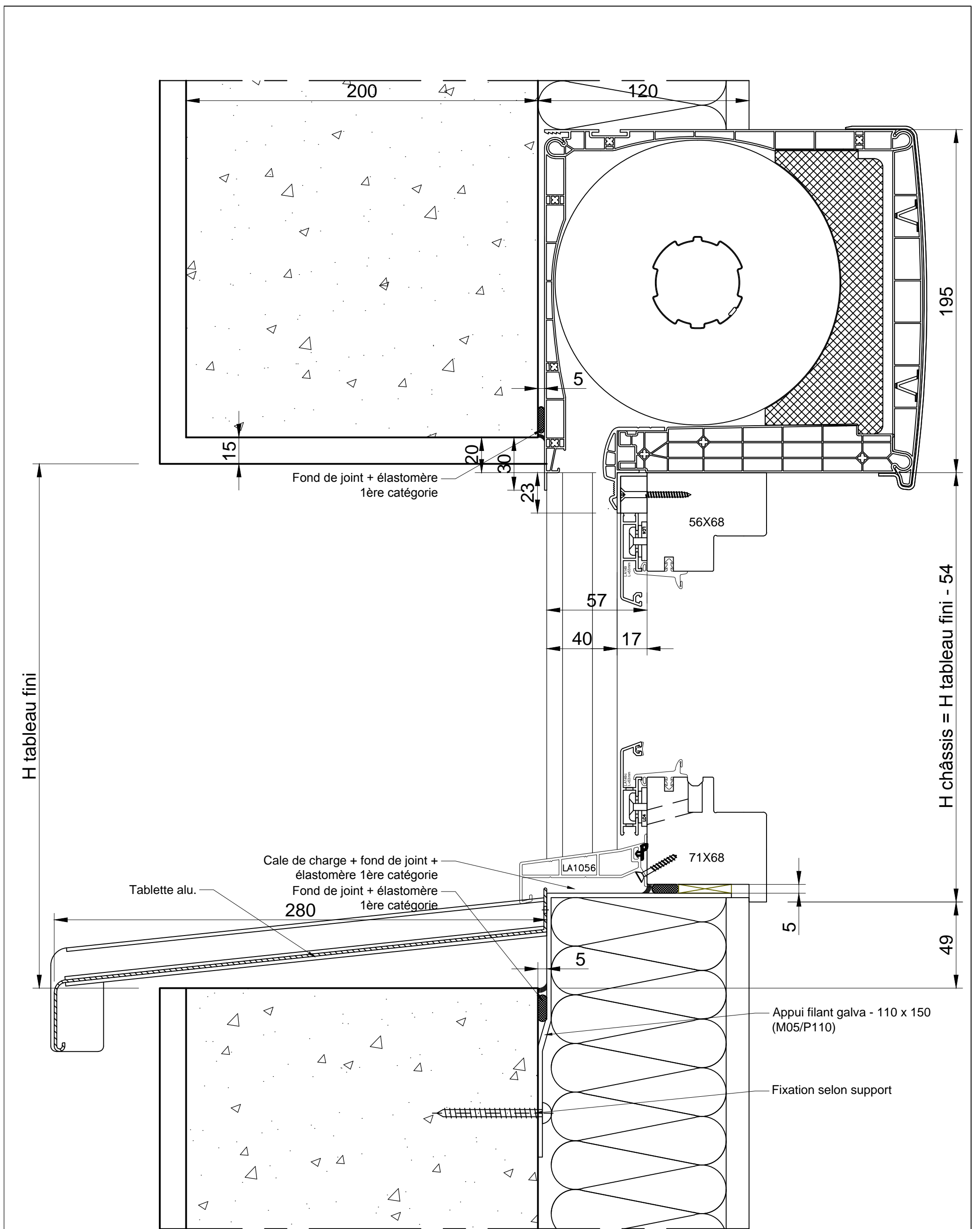

CATA TECH	Dessiné par E. TAVARES	Approuvé par -	Coupe Verticale	Modifié le 08/12/2020	Date 15/07/2020	Echelle 1/2 - A3
 Fabricant de Fenêtres et Portes.			APPLIQUE RATTRAPAGE ISO 120			
			MISE EN OEUVRE			Edition E

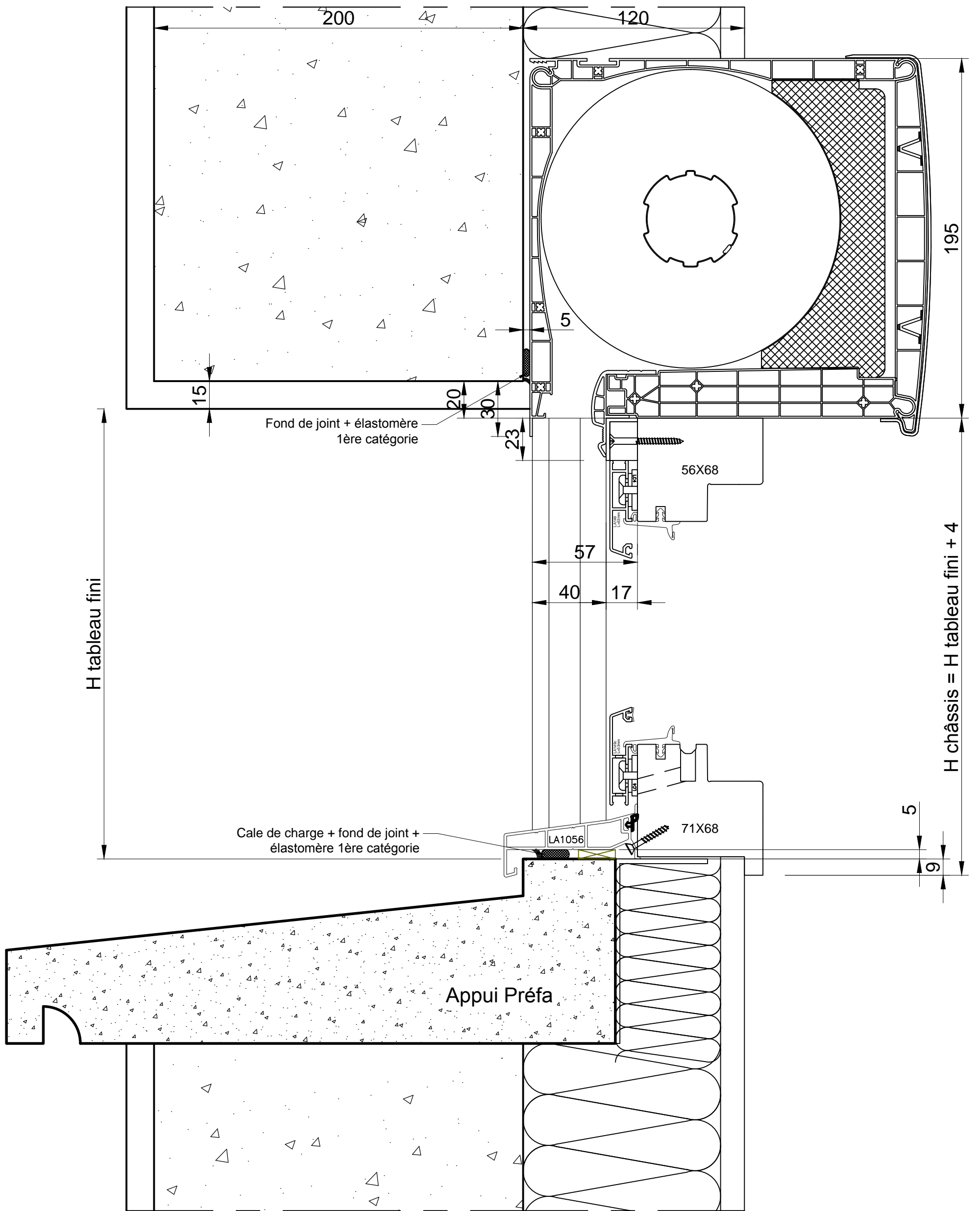

CATA TECH	Dessiné par E. TAVARES	Approuvé par -	Coupe Verticale	Modifié le 08/12/2020	Date 15/07/2020	Echelle 1/2 - A3
 <p>hilzinger Fabricant de Fenêtres et Portes.</p>			APPLIQUE RATTRAPAGE ISO 120			
			MISE EN OEUVRE			Edition E

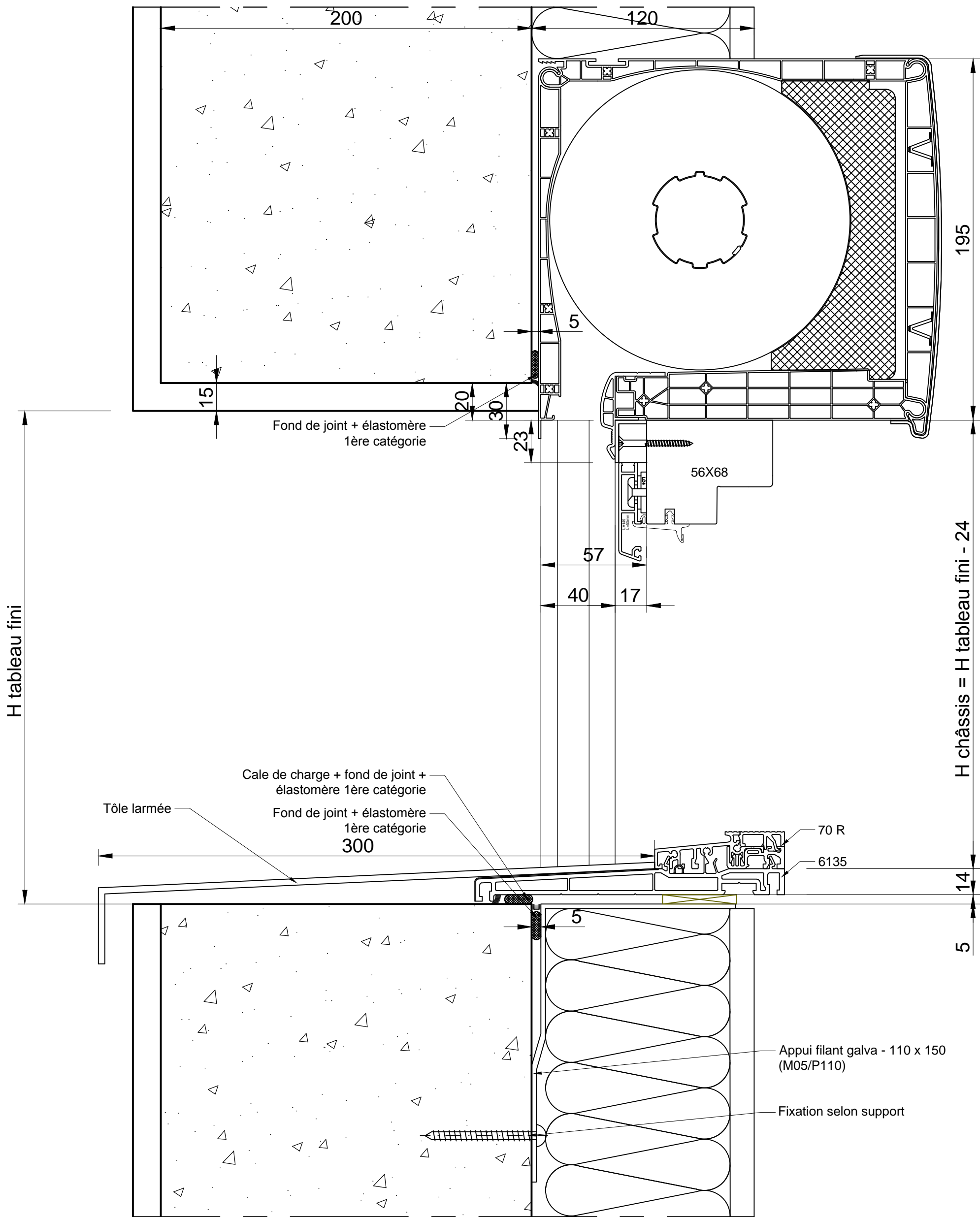

H tableau fini

H châssis = H tableau fini - 24

Tôle larmée
 Cale de charge + fond de joint +
 élastomère 1ère catégorie
 Fond de joint + élastomère
 1ère catégorie
 300

Appui filant galva - 110 x 150
 (M05/P110)
 Fixation selon support

CATA TECH	Dessiné par E. TAVARES	Approuvé par -	Coupe Verticale	Modifié le 08/12/2020	Date 15/07/2020	Echelle 1/2 - A3
 Fabricant de Fenêtres et Portes.			APPLIQUE RATTRAPAGE ISO 120			
			MISE EN OEUVRE			Edition E

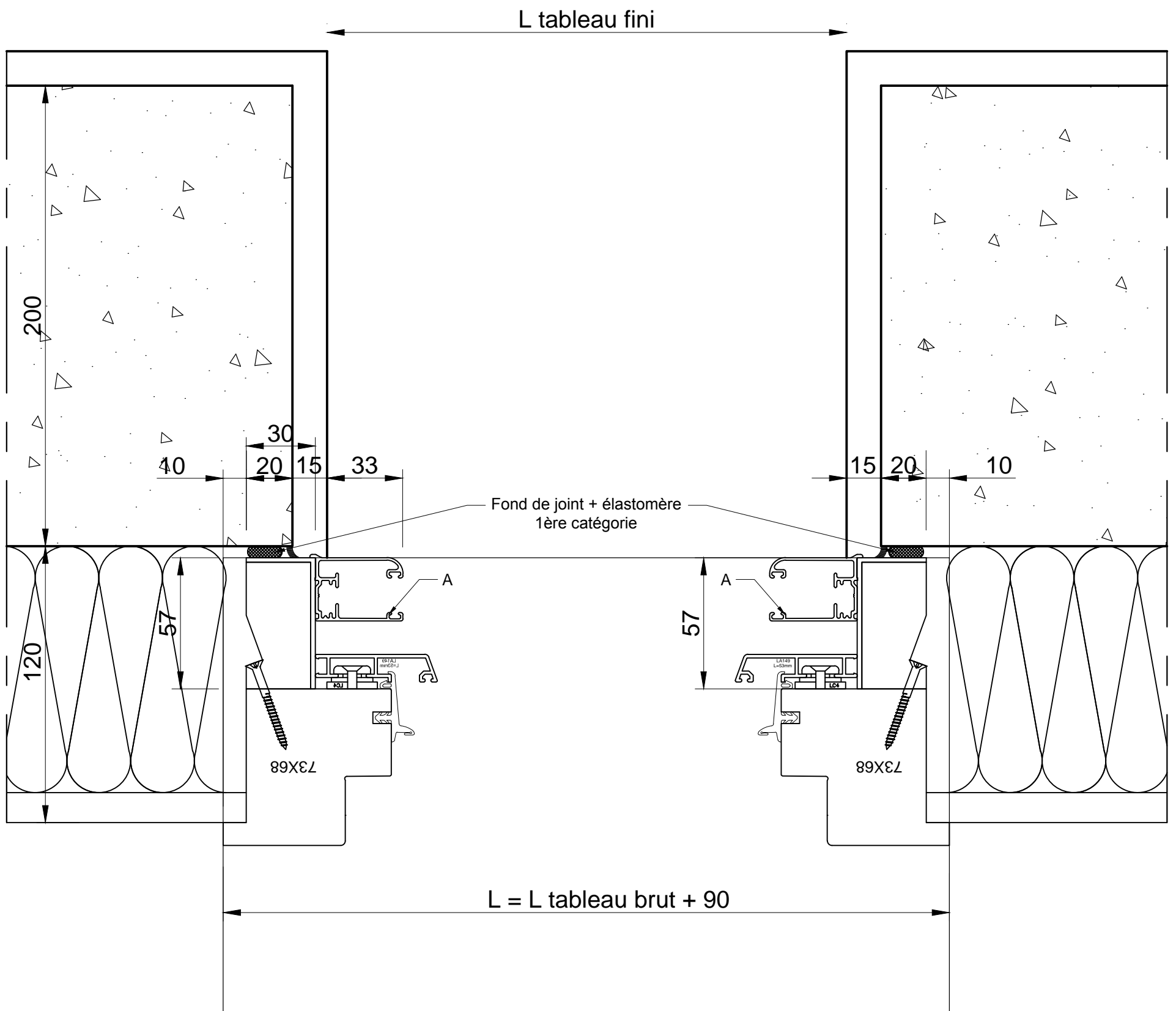

CATA TECH	Dessiné par E. TAVARES	Approuvé par -	Coupe Verticale	Modifié le 08/12/2020	Date 15/07/2020	Echelle 1/2 - A3
 Fabricant de Fenêtres et Portes.			APPLIQUE RATRAPAGE ISO 120			
			MISE EN OEUVRE			Edition E

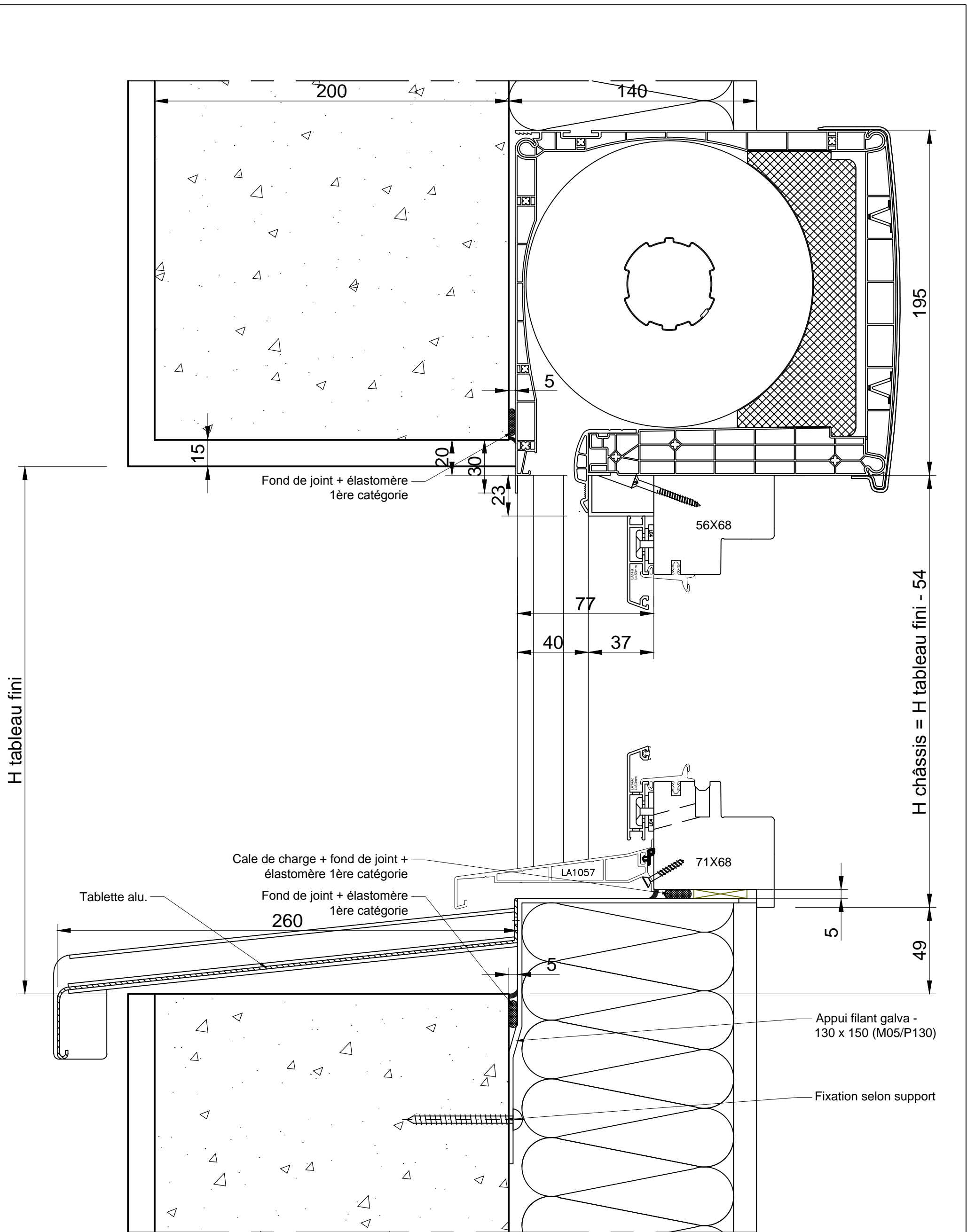

CATA TECH	Dessiné par E. TAVARES	Approuvé par -	Coupe Verticale	Modifié le 08/12/2020	Date 15/07/2020	Echelle 1/2 - A3
 Fabricant de Fenêtres et Portes.			APPLIQUE RATTRAPAGE ISO 140			
			MISE EN OEUVRE		Edition E	Feuille No. BOIS 23

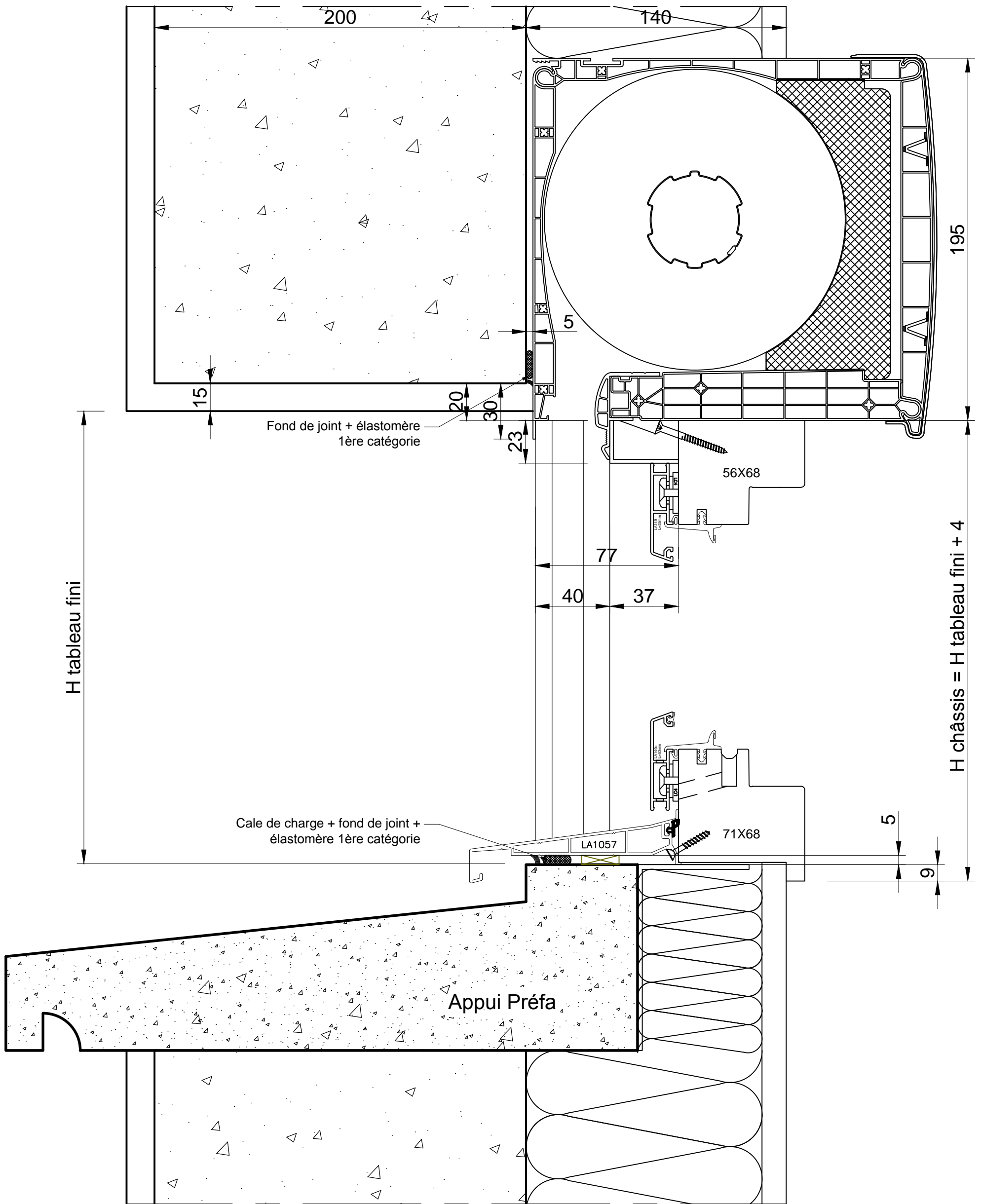

CATA TECH	Dessiné par E. TAVARES	Approuvé par -	Coupe Verticale	Modifié le 08/12/2020	Date 15/07/2020	Echelle 1/2 - A3
 Fabricant de Fenêtres et Portes.			APPLIQUE RATTRAPAGE ISO 140			
			MISE EN OEUVRE			Edition E

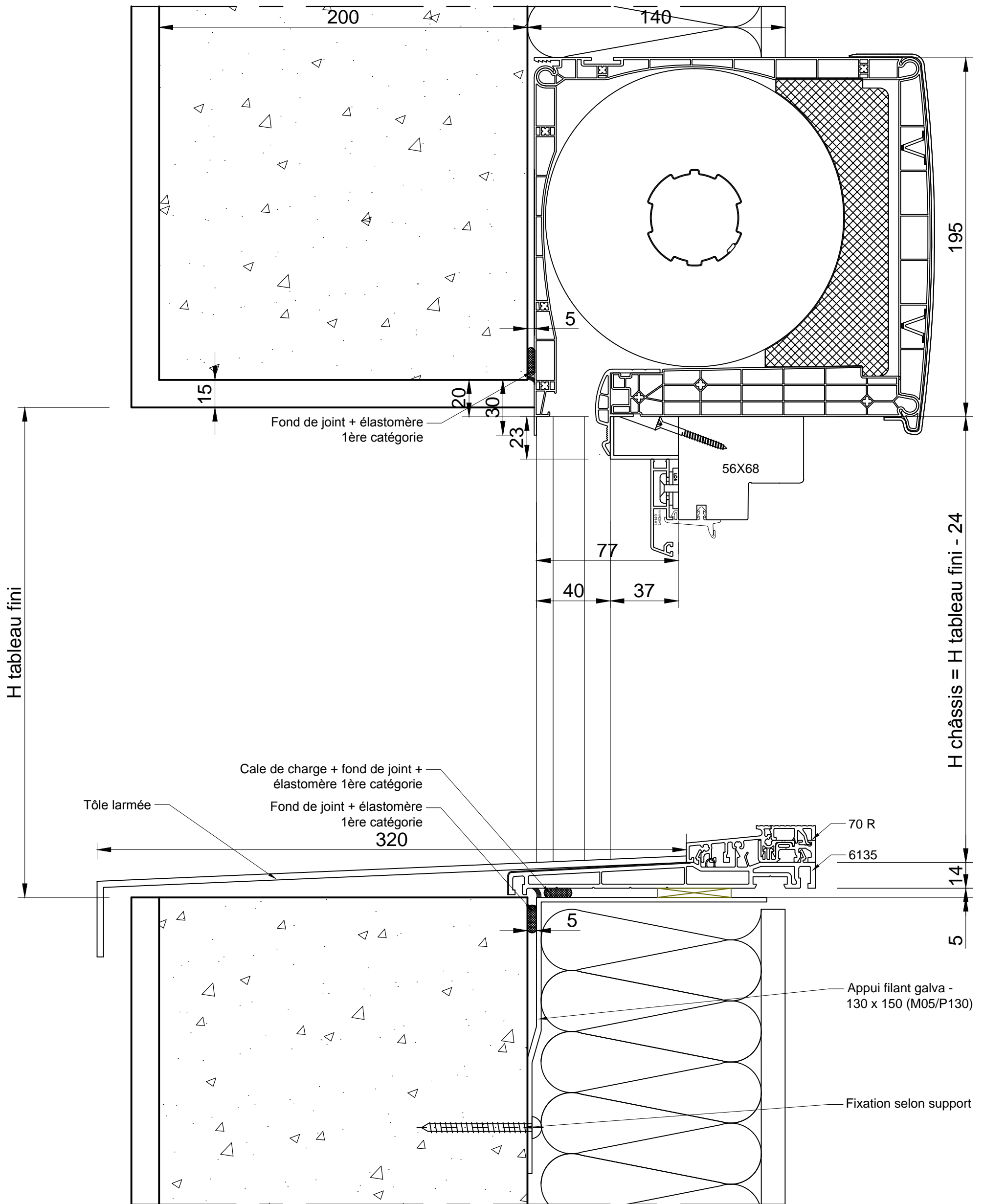

CATA TECH	Dessiné par E. TAVARES	Approuvé par -	Coupe Verticale	Modifié le 08/12/2020	Date 15/07/2020	Echelle 1/2 - A3
 Fabricant de Fenêtres et Portes.			APPLIQUE RATTRAPAGE ISO 140			
			MISE EN OEUVRE		Edition E	Feuille No. BOIS 25

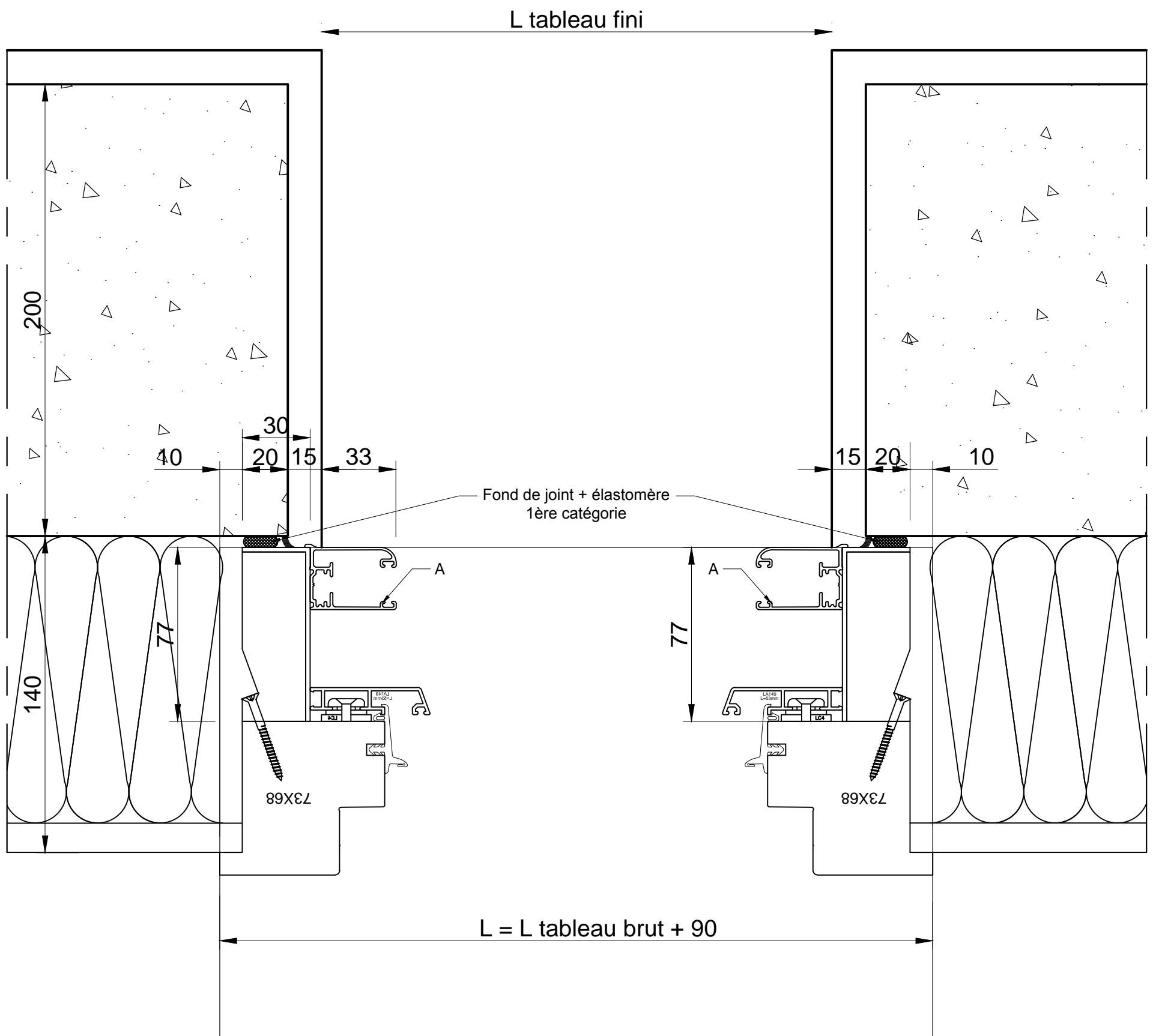

CATA TECH	Dessiné par E. TAVARES	Approuvé par -	Coupe Verticale	Modifié le 08/12/2020	Date 15/07/2020	Echelle 1/2 - A3
 Fabricant de Fenêtres et Portes.			APPLIQUE RATTRAPAGE ISO 140			
			MISE EN OEUVRE			Edition E

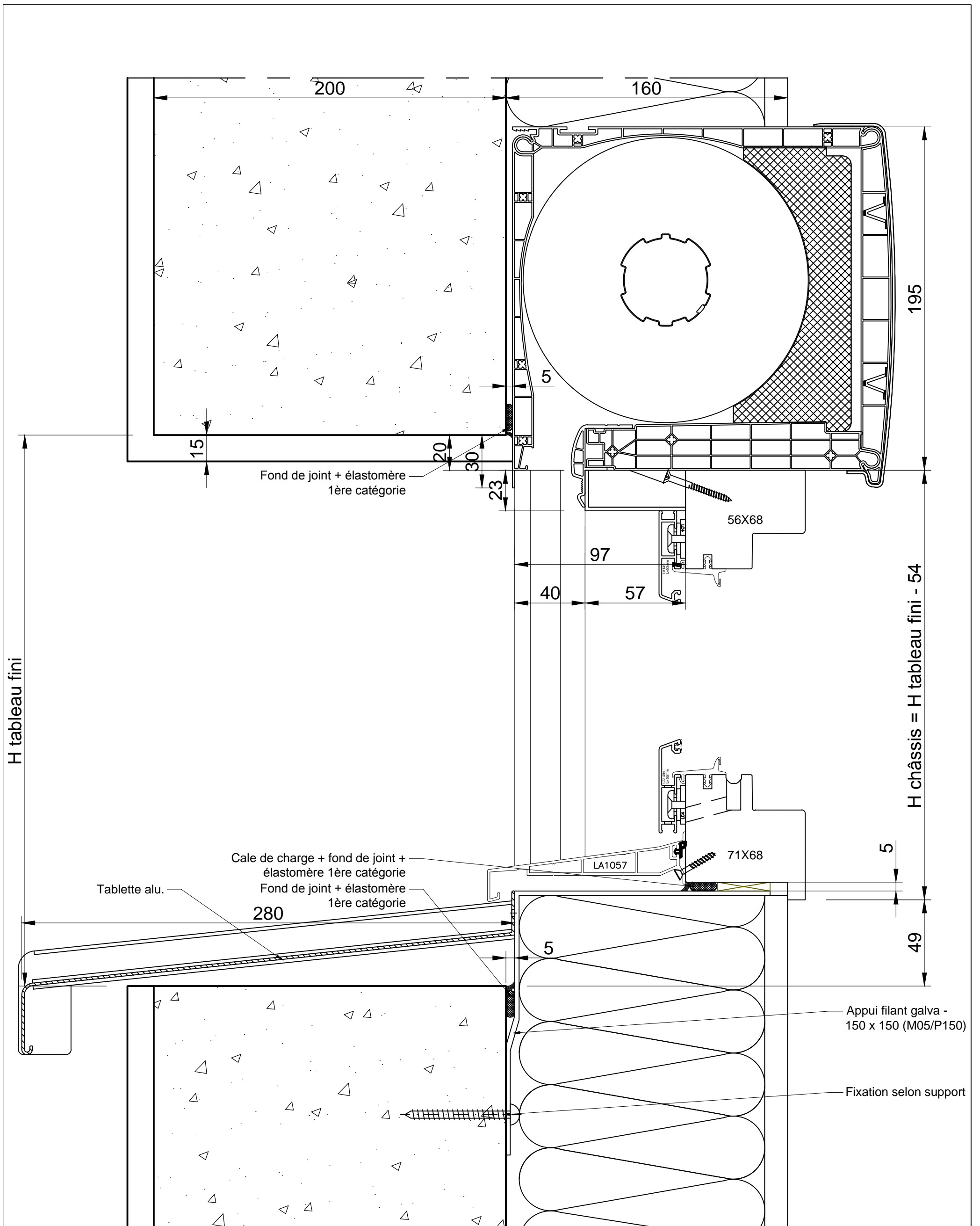

CATA TECH	Dessiné par E. TAVARES	Approuvé par -	Coupe Verticale	Modifié le 08/12/2020	Date 15/07/2020	Echelle 1/2 - A3
 Fabricant de Fenêtres et Portes.			APPLIQUE RATTRAPAGE ISO 160			
			MISE EN OEUVRE		Edition E	Feuille No. BOIS 27

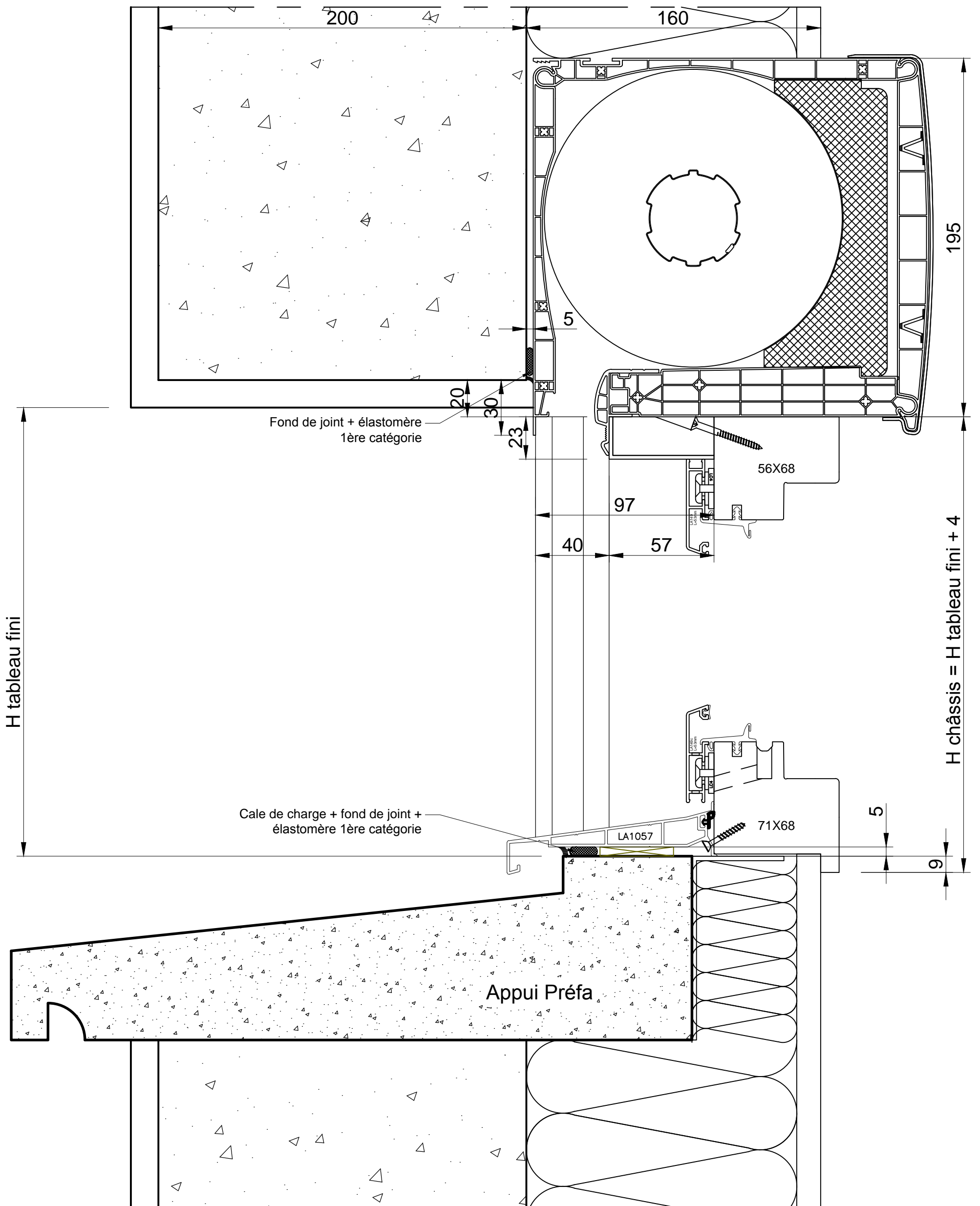

CATA TECH	Dessiné par E. TAVARES	Approuvé par -	Coupe Verticale	Modifié le 08/12/2020	Date 15/07/2020	Echelle 1/2 - A3
 Fabricant de Fenêtres et Portes.			APPLIQUE RATTRAPAGE ISO 160			
			MISE EN OEUVRE			Edition E

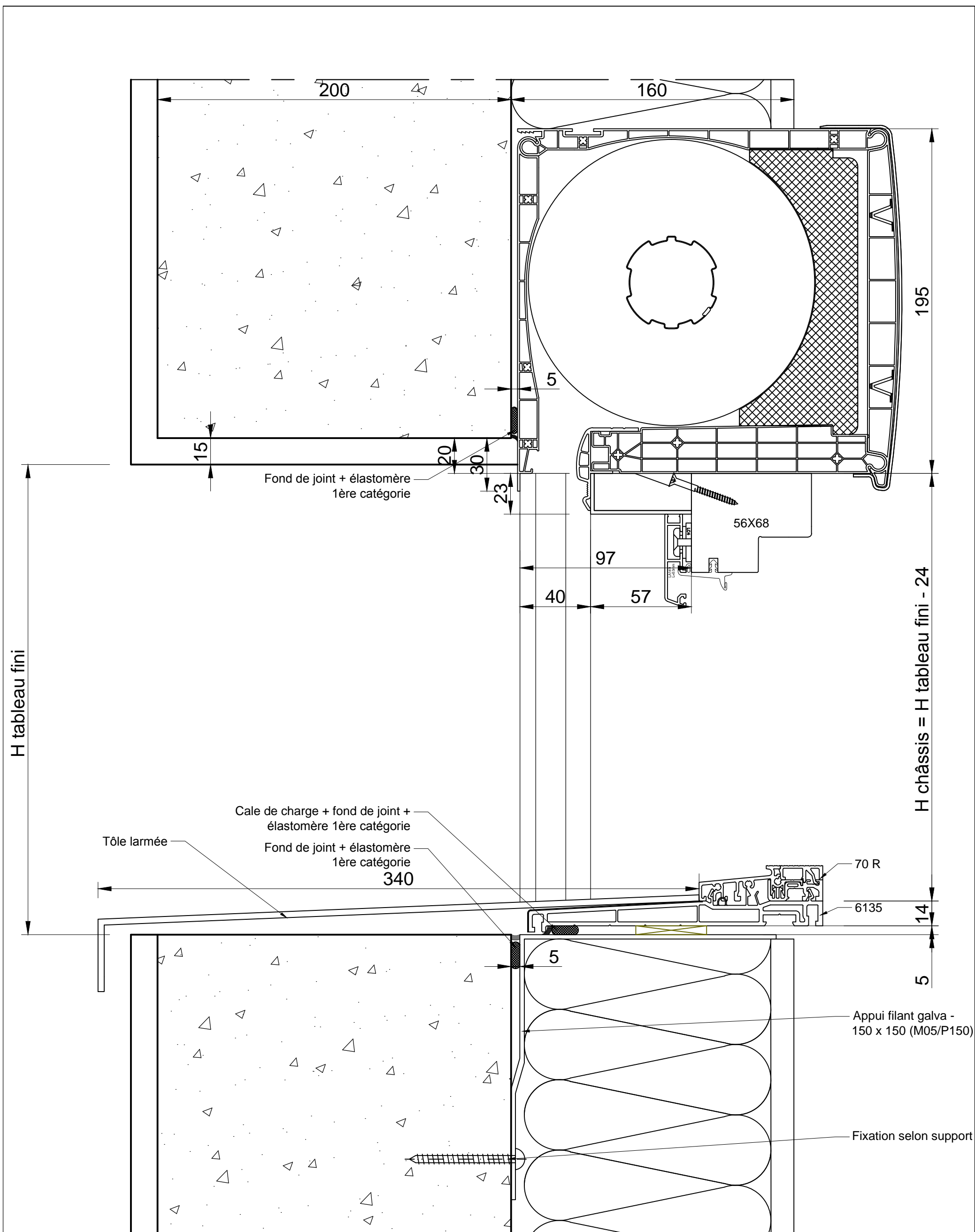

CATA TECH	Dessiné par E. TAVARES	Approuvé par -	Coupe Verticale	Modifié le 08/12/2020	Date 15/07/2020	Echelle 1/2 - A3
 <p>hilzinger Fabricant de Fenêtres et Portes.</p>			APPLIQUE RATTRAPAGE ISO 160			
			MISE EN OEUVRE			Edition E

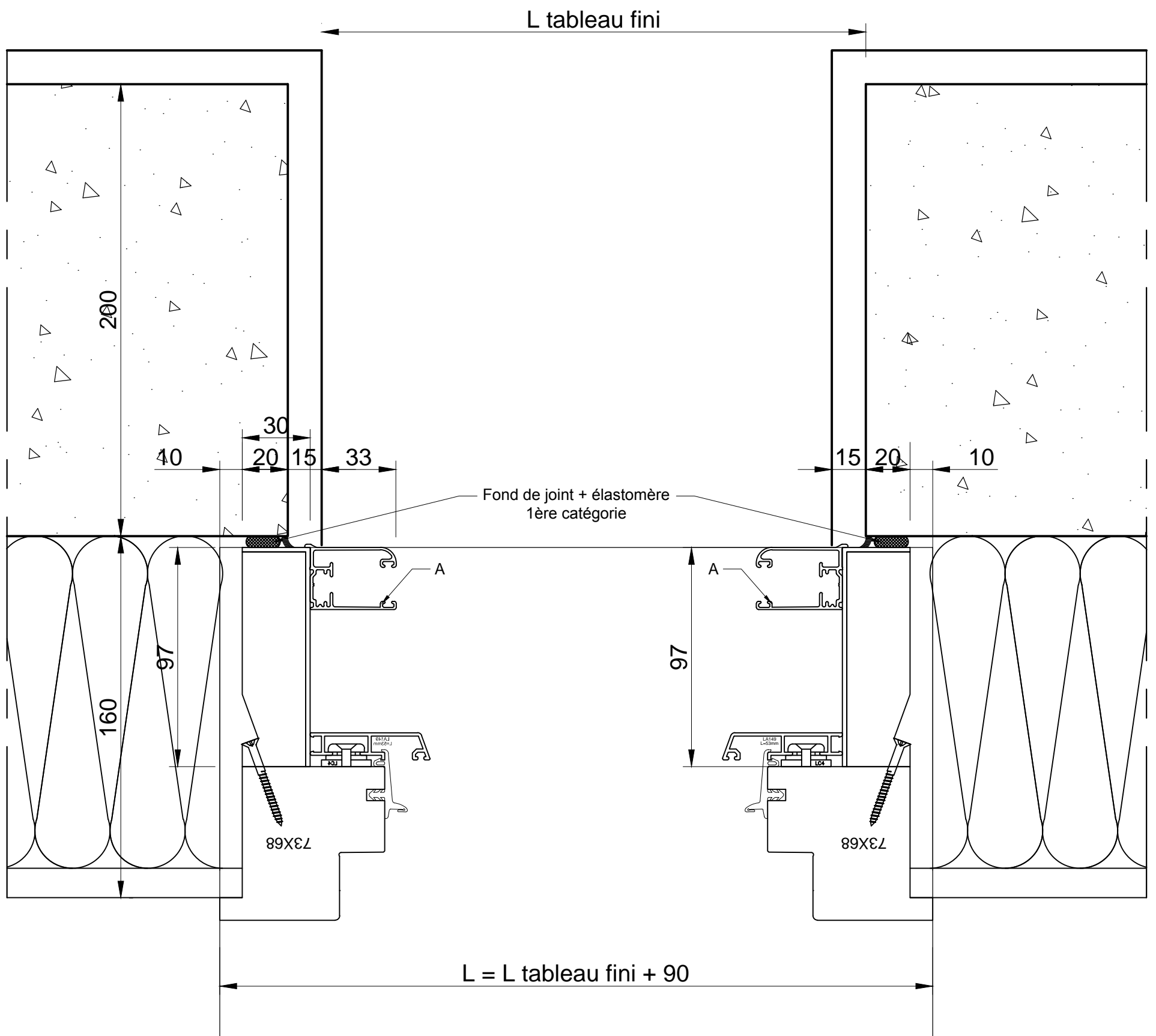

CATA TECH	Dessiné par E. TAVARES	Approuvé par -	Coupe Verticale	Modifié le 08/12/2020	Date 15/07/2020	Echelle 1/2 - A3
 Fabricant de Fenêtres et Portes.			APPLIQUE RATTRAPAGE ISO 160			
			MISE EN OEUVRE			Edition E

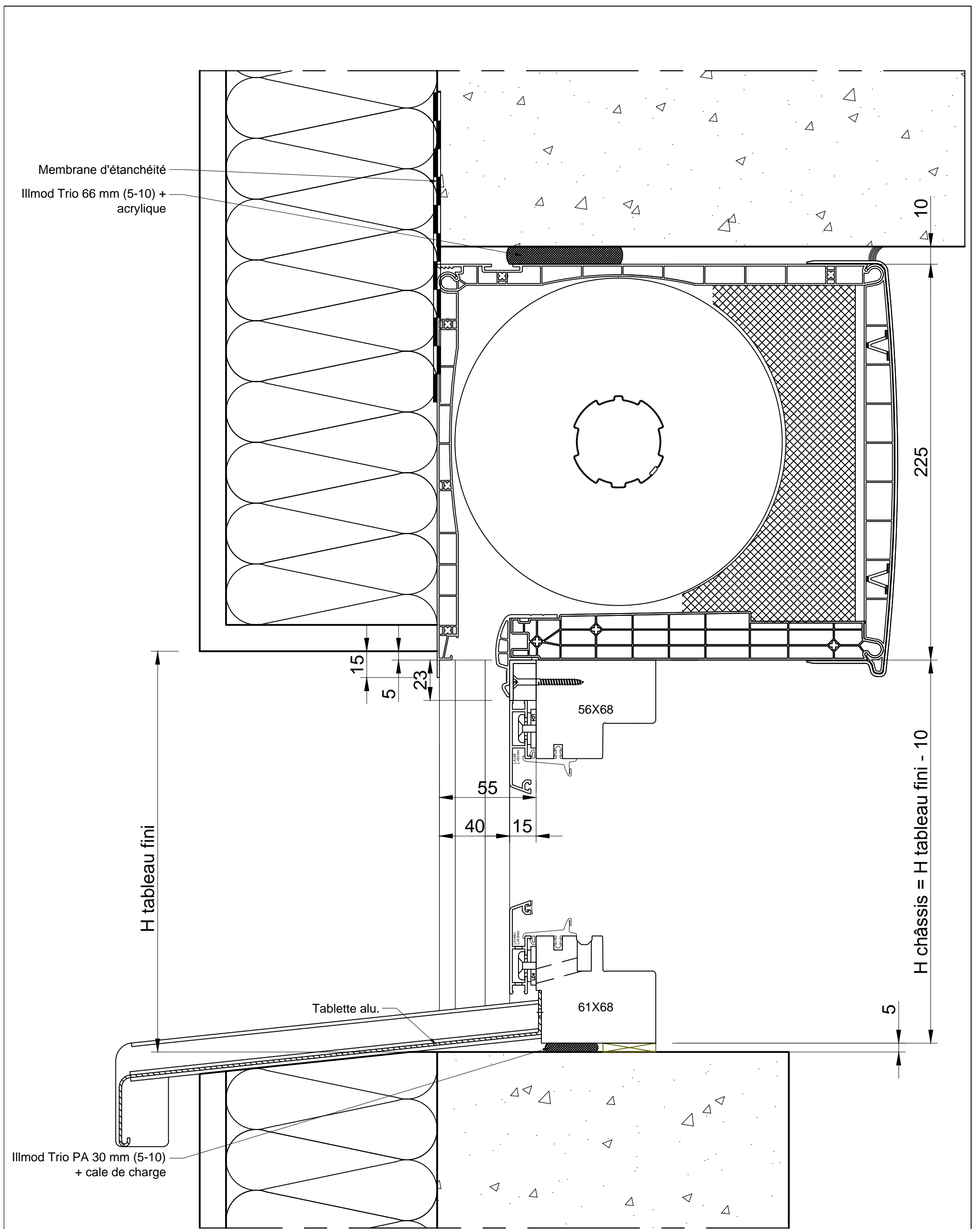

CATA TECH	Dessiné par E. TAVARES	Approuvé par -	Coupe Verticale	Modifié le 08/12/2020	Date 15/07/2020	Echelle 1/2 - A3
 Fabricant de Fenêtres et Portes.			POSE EN TUNNEL			
			MISE EN OEUVRE	Edition E	Feuille No. BOIS 31	

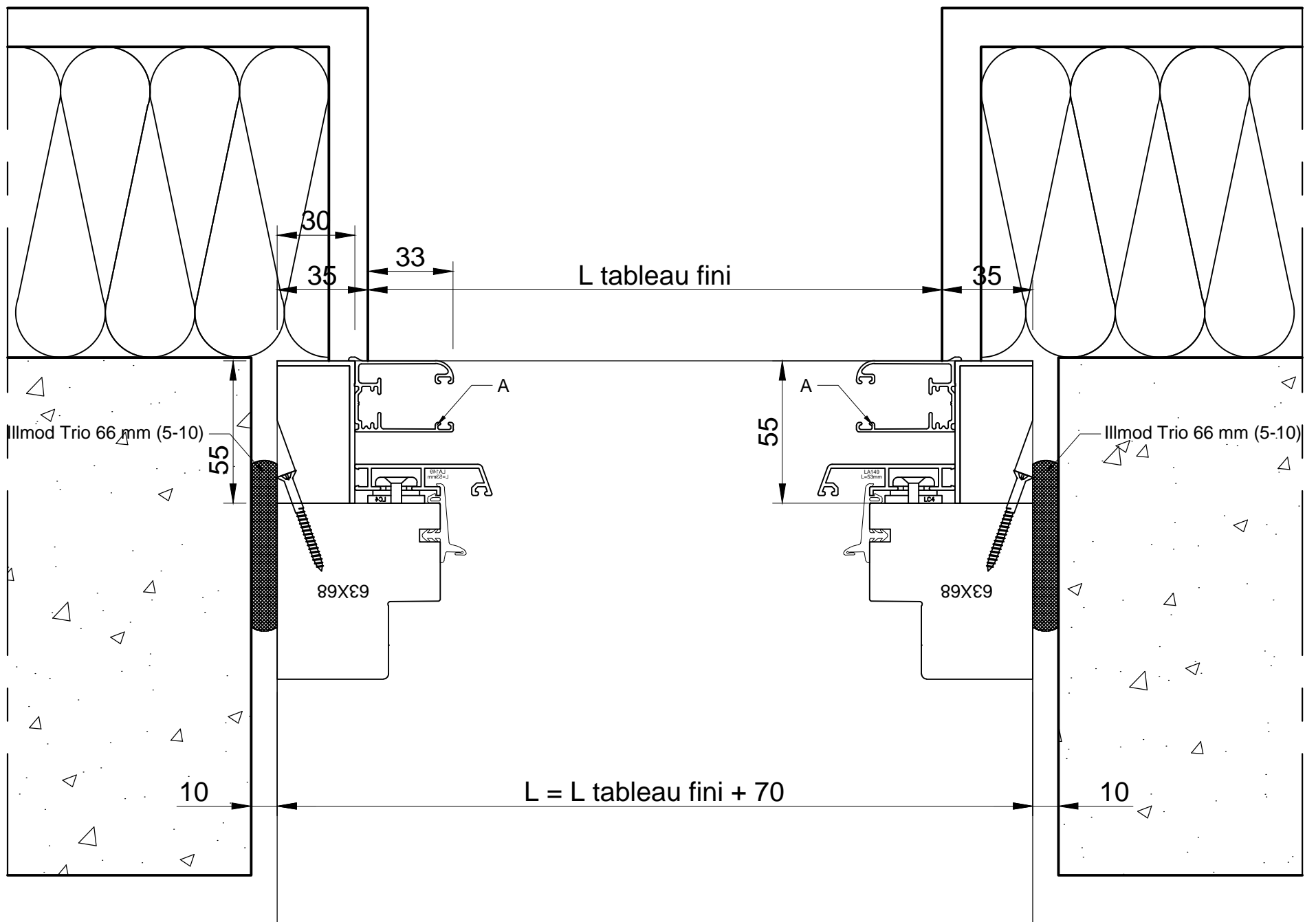

CATA TECH	Dessiné par E. TAVARES	Approuvé par -	Coupe Verticale	Modifié le 08/12/2020	Date 15/07/2020	Echelle 1/2 - A3
 Fabricant de Fenêtres et Portes.			POSE EN TUNNEL			
			MISE EN OEUVRE	Edition E	Feuille No. BOIS 32	

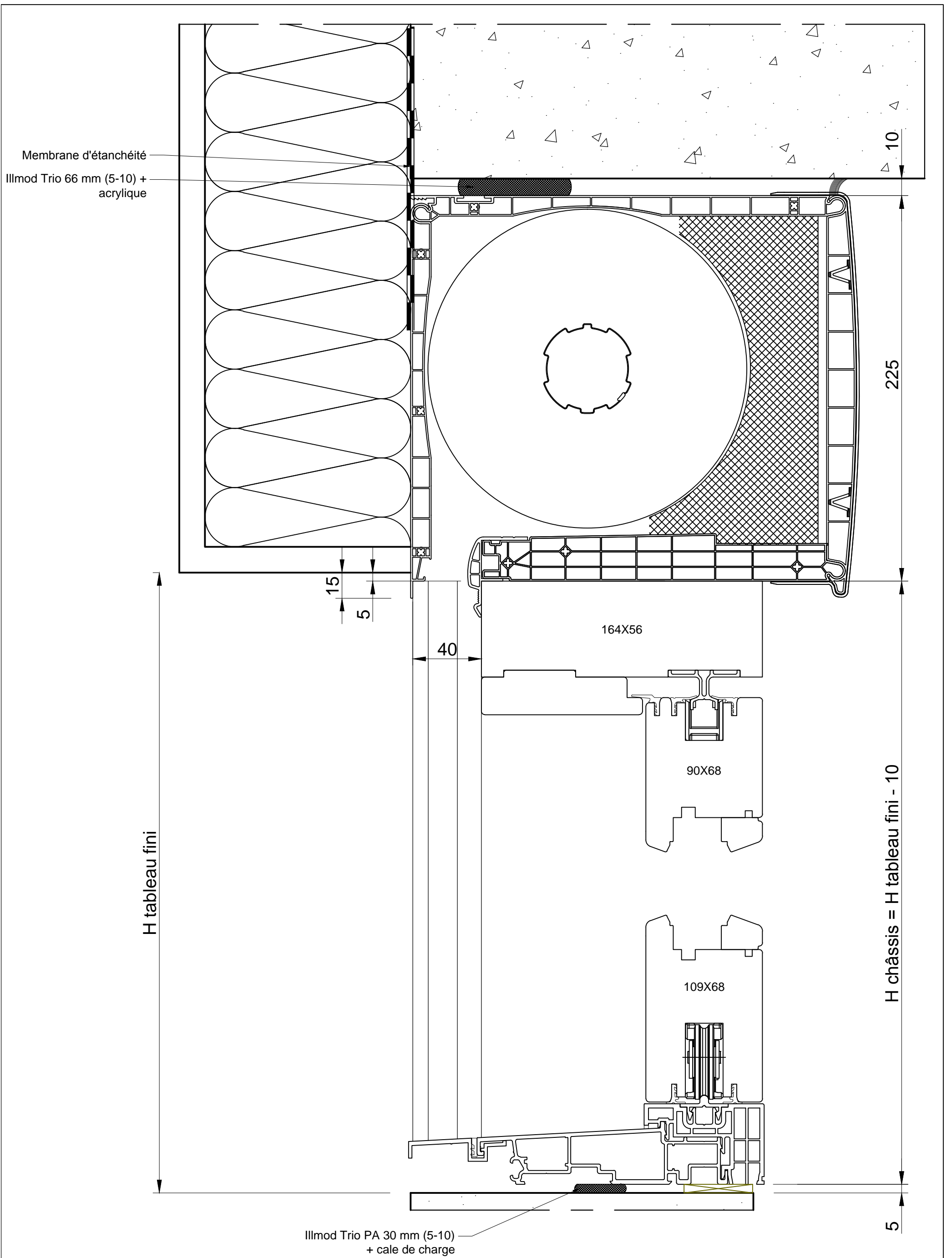

CATA TECH	Dessiné par E. TAVARES	Approuvé par -	Coupe Verticale	Modifié le 08/12/2020	Date 15/07/2020	Echelle 1/2 - A3
 Fabricant de Fenêtres et Portes.			COULISSANT LEVANT			
			MISE EN OEUVRE	Edition E	Feuille No. BOIS 33	

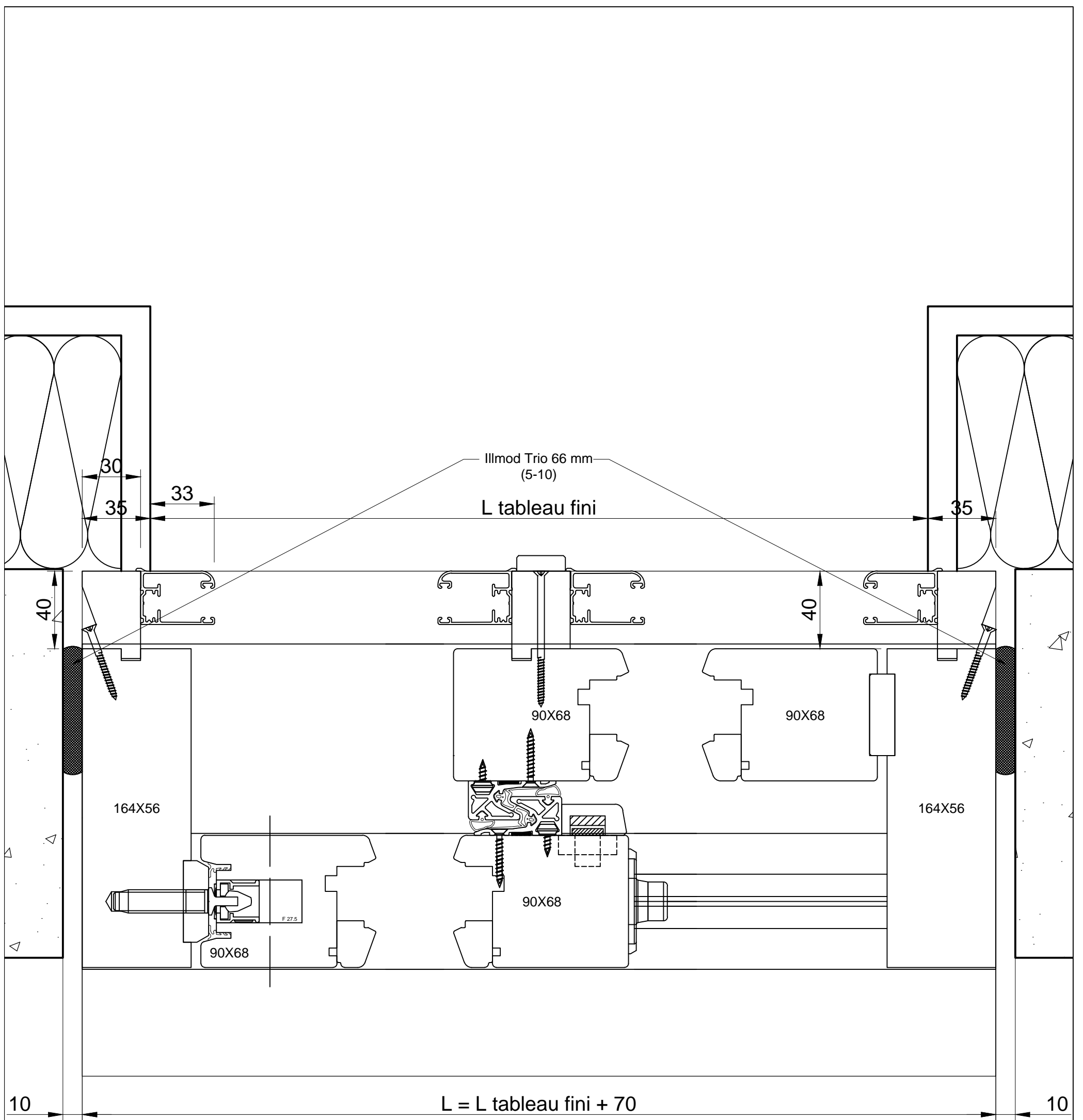

CATA TECH	Dessiné par E. TAVARES	Approuvé par -	Coupe Verticale	Modifié le 08/12/2020	Date 15/07/2020	Echelle 1/2 - A3
 Fabricant de Fenêtres et Portes.			COULISSANT LEVANT			
			MISE EN OEUVRE	Edition E	Feuille No. BOIS 34	

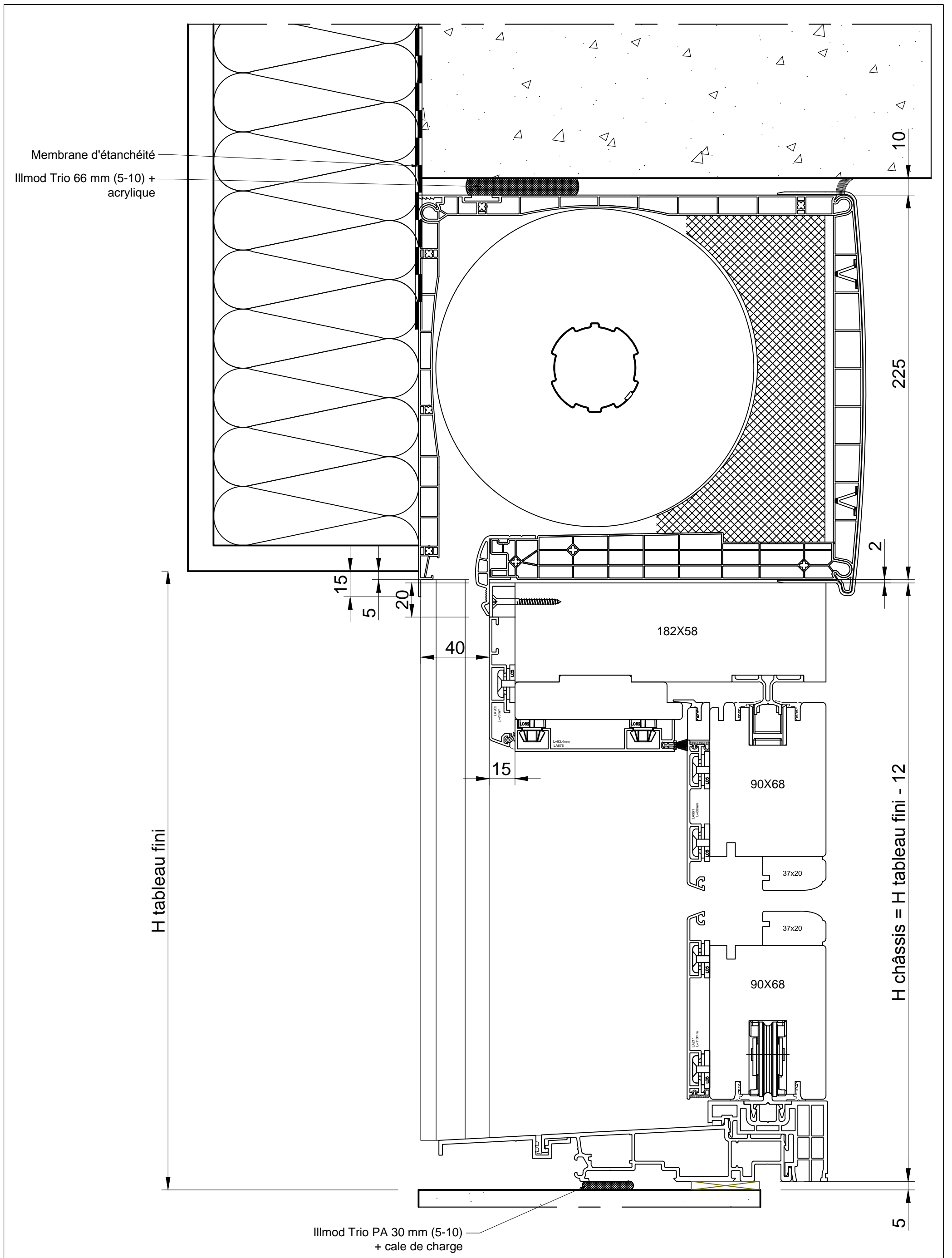

CATA TECH	Dessiné par E. TAVARES	Approuvé par -	Coupe Verticale	Modifié le 08/12/2020	Date 15/07/2020	Echelle 1/2 - A3
 Fabricant de Fenêtres et Portes.			COULISSANT LEVANT			
			MISE EN OEUVRE	Edition E	Feuille No. BOIS 35	

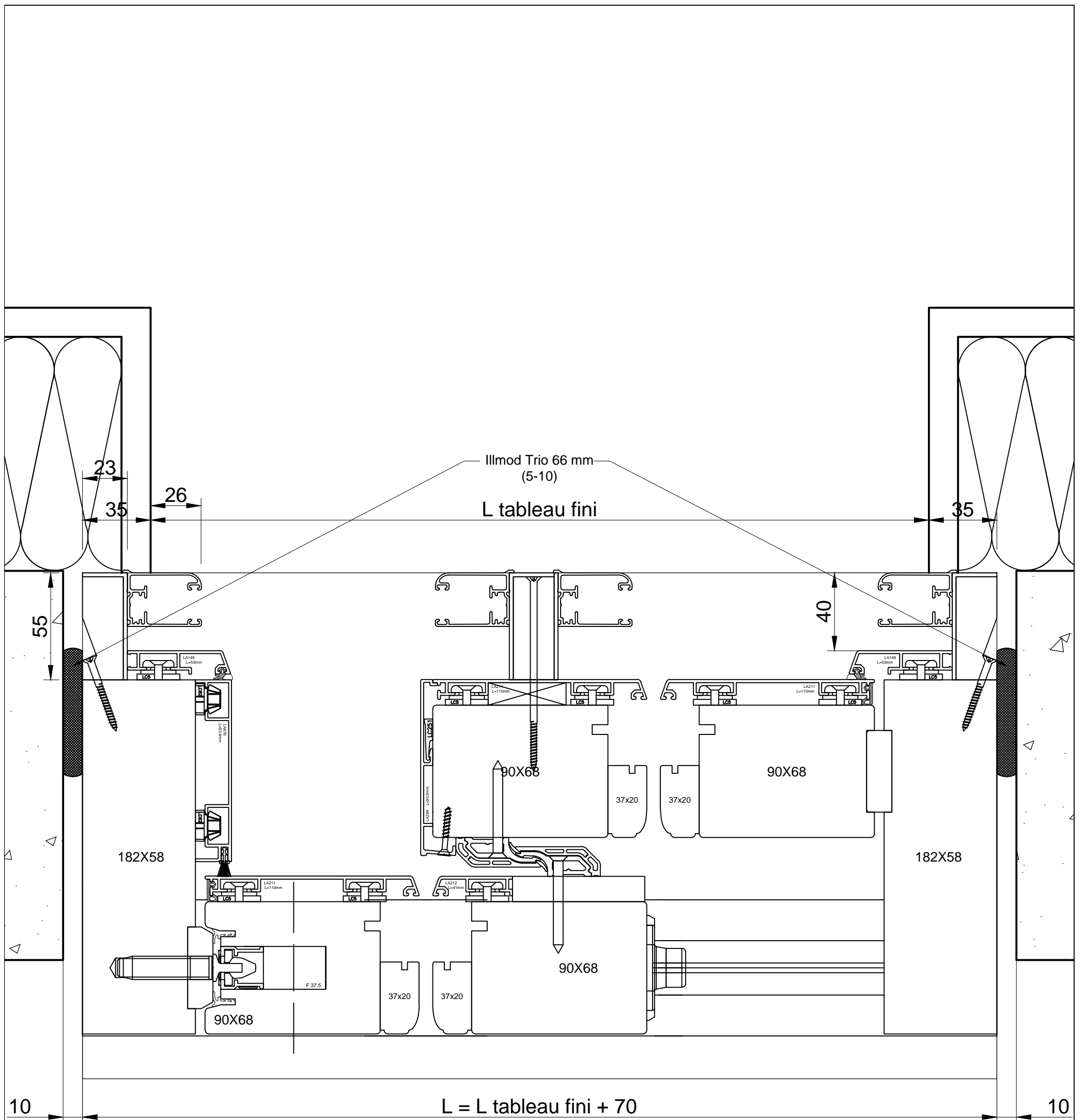

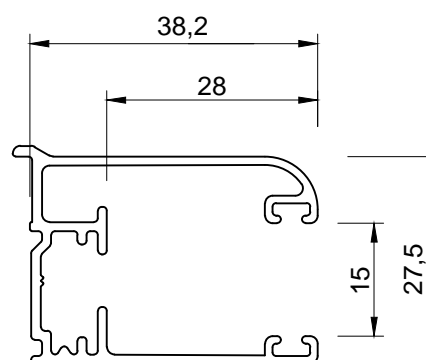

CATA TECH	Dessiné par E. TAVARES	Approuvé par -	Coupe Verticale	Modifié le 08/12/2020	Date 15/07/2020	Echelle 1/2 - A3
 Fabricant de Fenêtres et Portes.			COULISSANT LEVANT			
			MISE EN OEUVRE	Edition E	Feuille No. BOIS 36	

COULISSE MONO : A

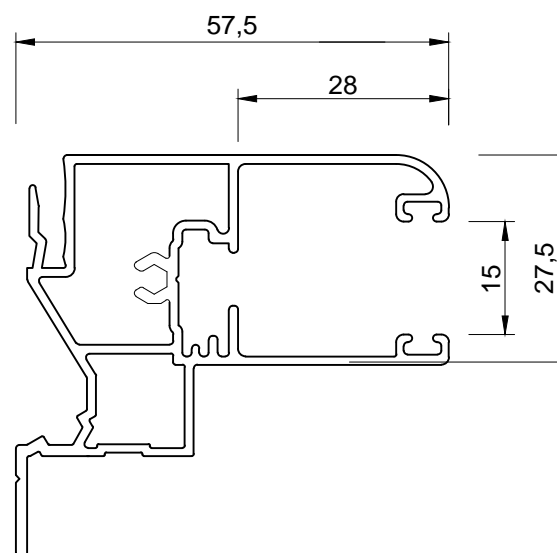

COULISSE RENO : R40



CATA TECH	Dessiné par E. TAVARES	Approuvé par -	Coupe Verticale	Modifié le 08/12/2020	Date 15/07/2020	Echelle 1/1 - A3
 Fabricant de Fenêtres et Portes.			COULISSES ALU			
			MISE EN OEUVRE			Edition E

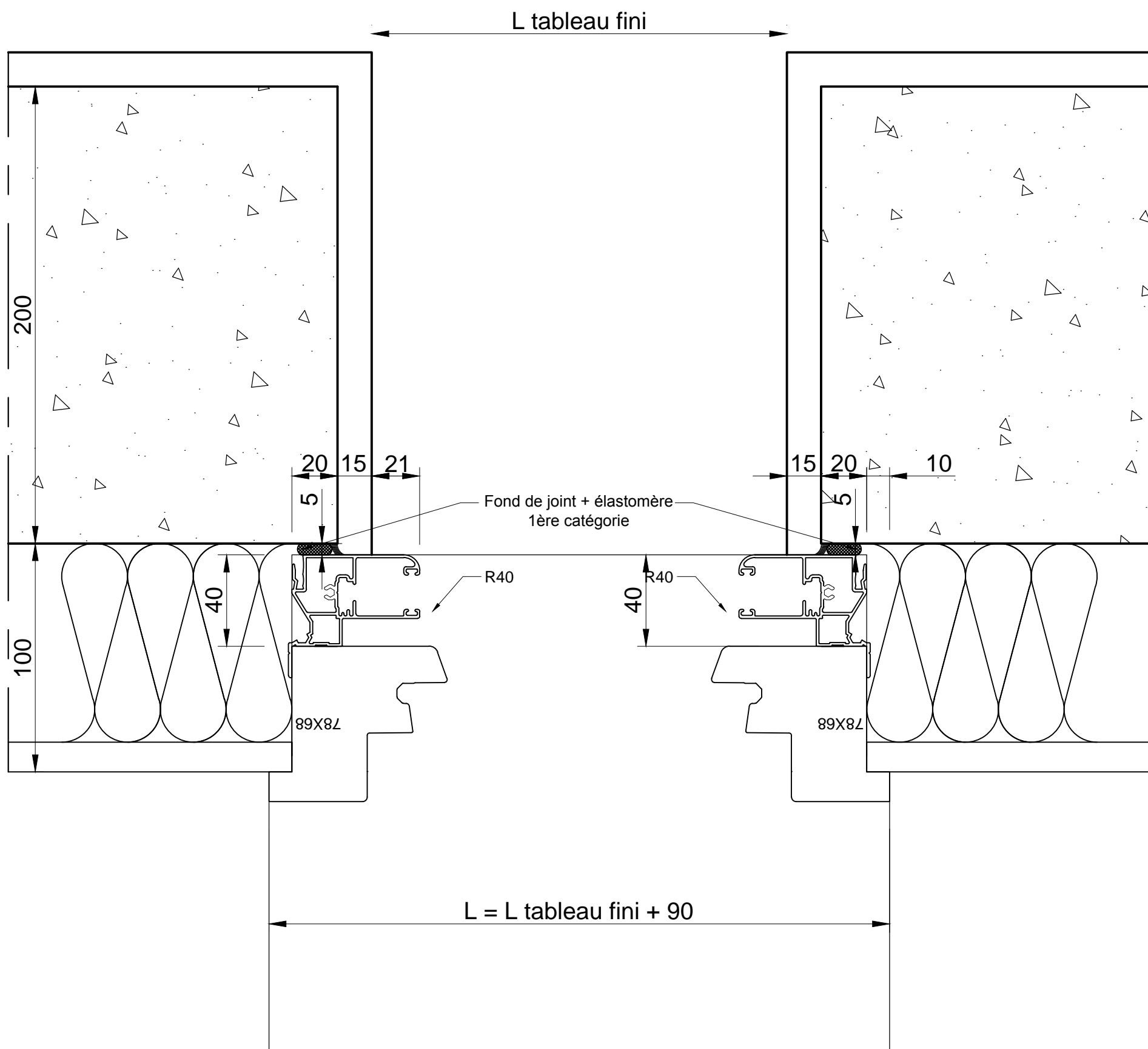

CATA TECH	Dessiné par E. TAVARES	Approuvé par -	Coupe Verticale	Modifié le 08/12/2020	Date 15/07/2020	Echelle 1/2 - A3
 Fabricant de Fenêtres et Portes.			APPLIQUE OU FEUILLURE			
			MISE EN OEUVRE			Edition E

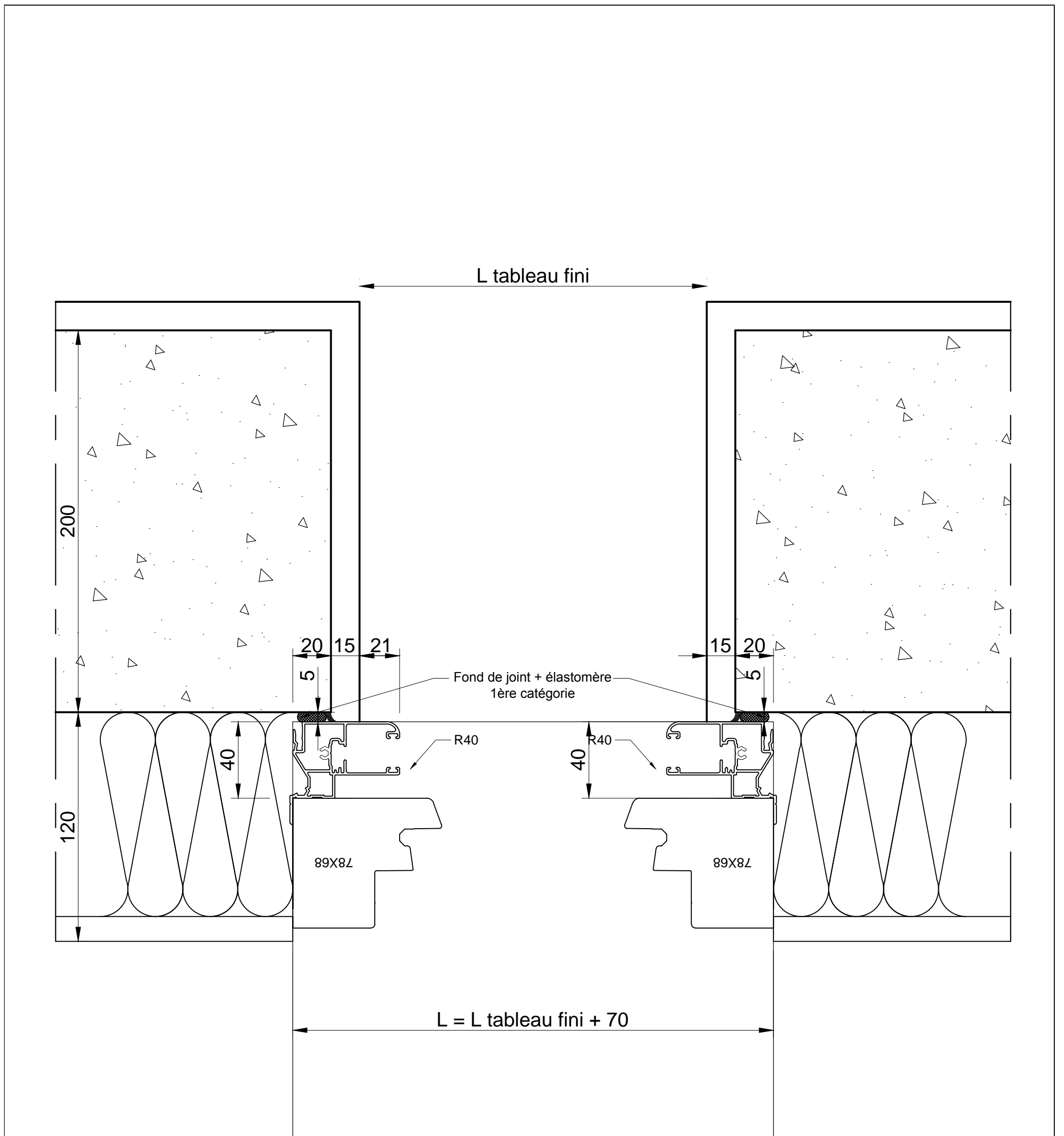

CATA TECH	Dessiné par E. TAVARES	Approuvé par -	Coupe Verticale	Modifié le 08/12/2020	Date 15/07/2020	Echelle 1/2 - A3
 Fabricant de Fenêtres et Portes.			APPLIQUE OU FEUILLURE			
			MISE EN OEUVRE			Edition E

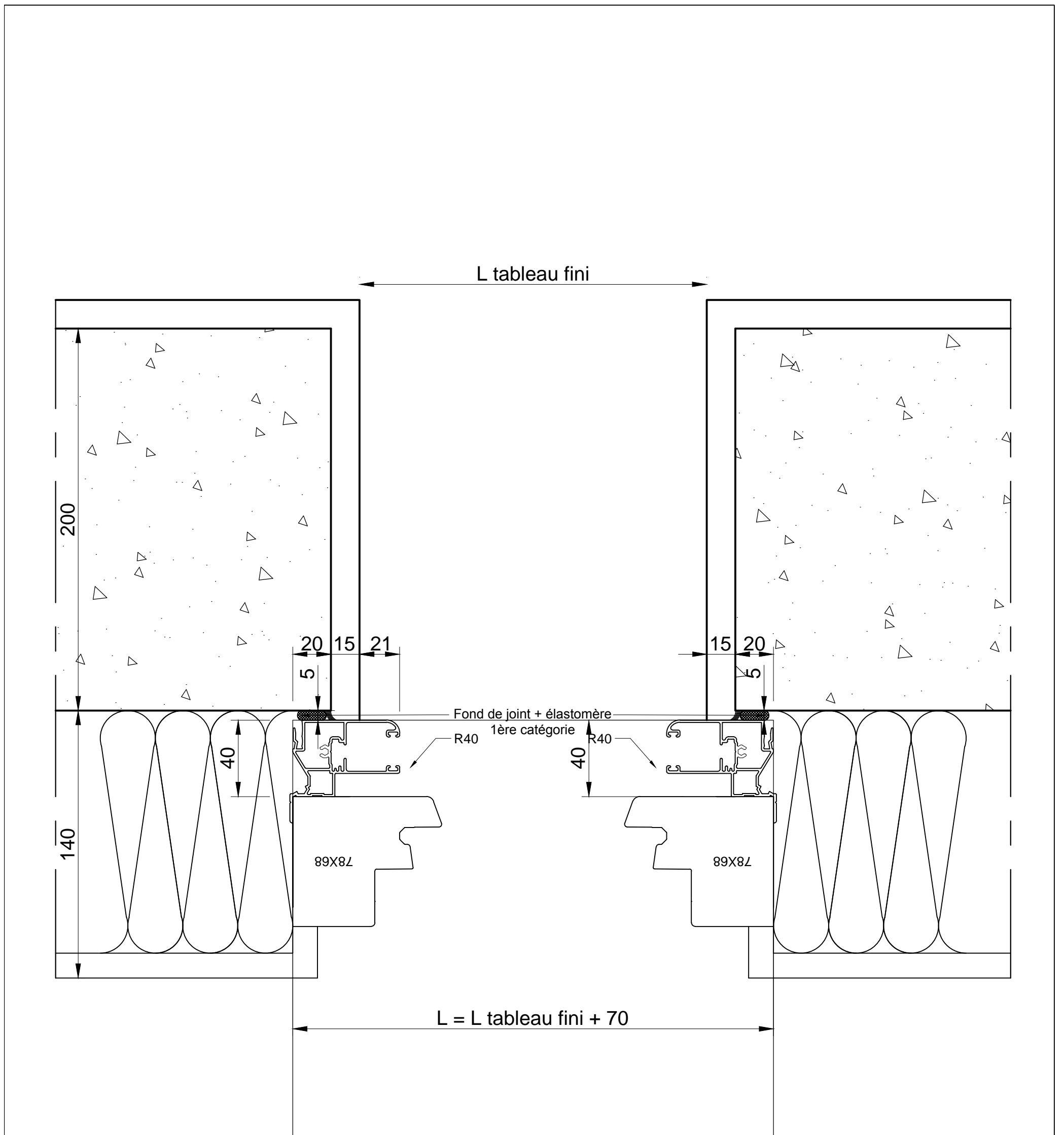

CATA TECH	Dessiné par E. TAVARES	Approuvé par -	Coupe Verticale	Modifié le 08/12/2020	Date 15/07/2020	Echelle 1/2 - A3
 Fabricant de Fenêtres et Portes.			APPLIQUE OU FEUILLURE			
			MISE EN OEUVRE			Edition E

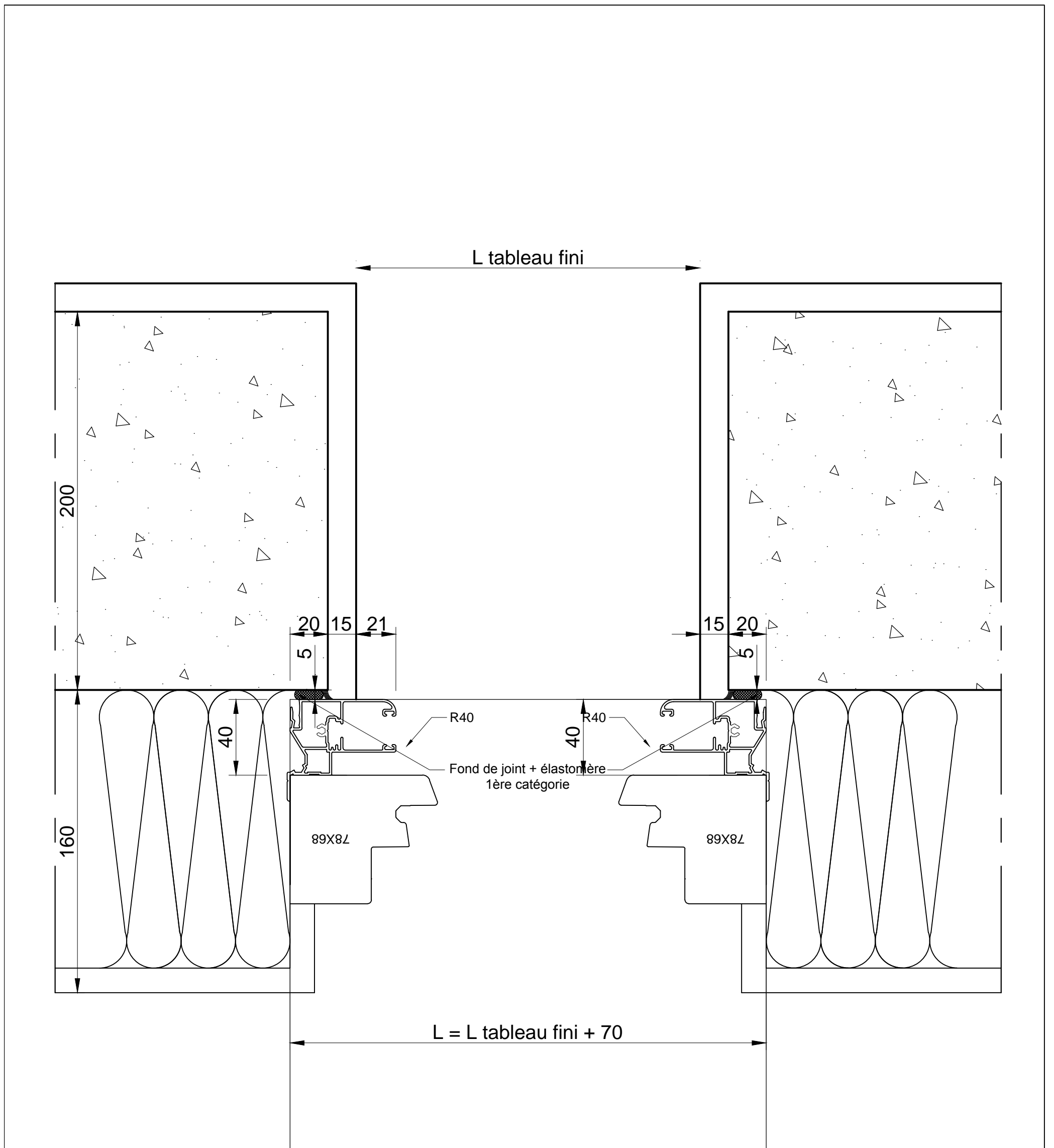

CATA TECH	Dessiné par E. TAVARES	Approuvé par -	Coupe Verticale	Modifié le 08/12/2020	Date 15/07/2020	Echelle 1/2 - A3
 Fabricant de Fenêtres et Portes.			APPLIQUE OU FEUILLURE			
			MISE EN OEUVRE			Edition E

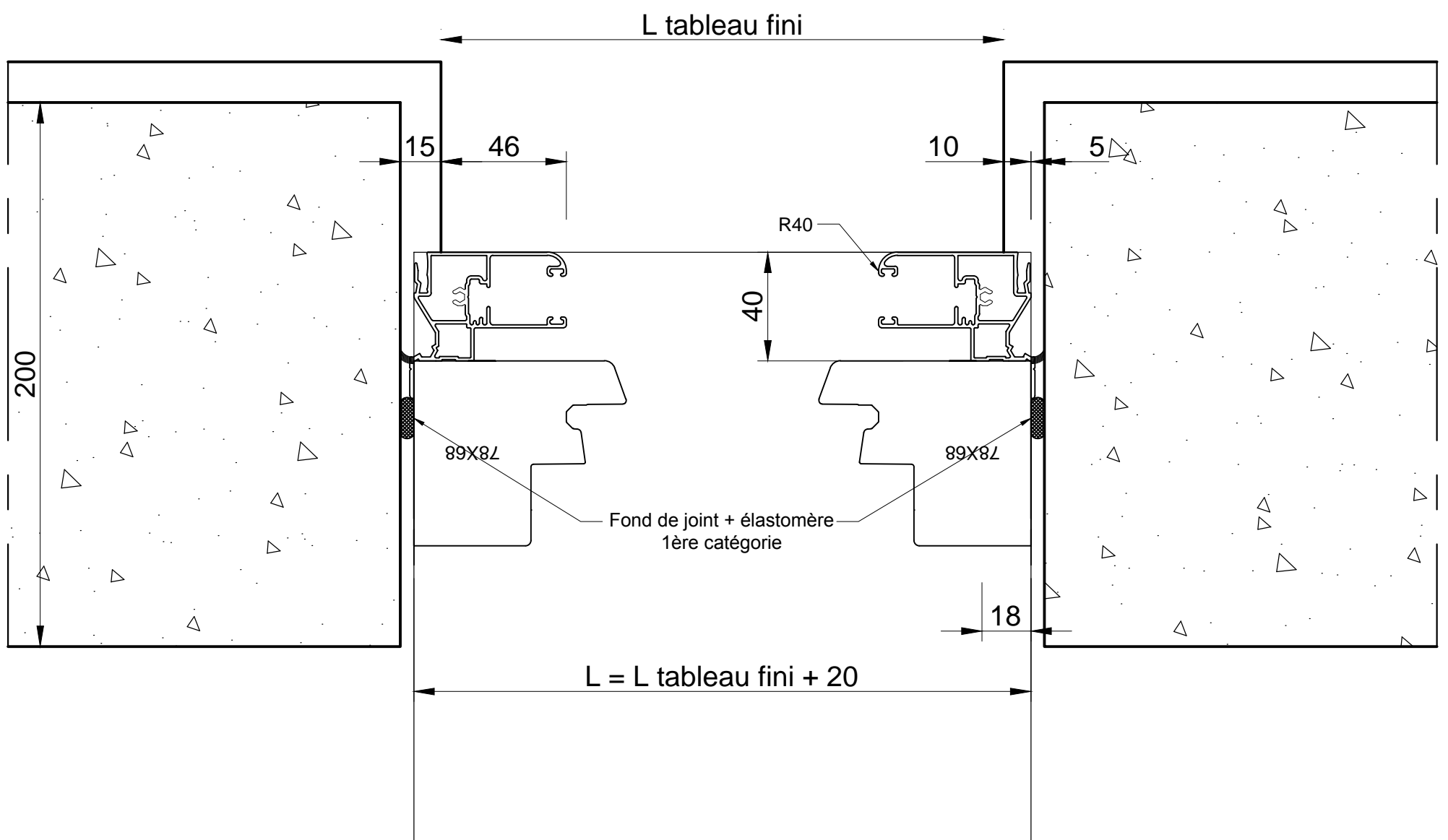

CATA TECH	Dessiné par E. TAVARES	Approuvé par -	Coupe Verticale	Modifié le 08/12/2020	Date 15/07/2020	Echelle 1/2 - A3
 Fabricant de Fenêtres et Portes.			POSE EN TUNNEL			
			MISE EN OEUVRE		Edition E	Feuille No. BOIS 42