

UNI 8

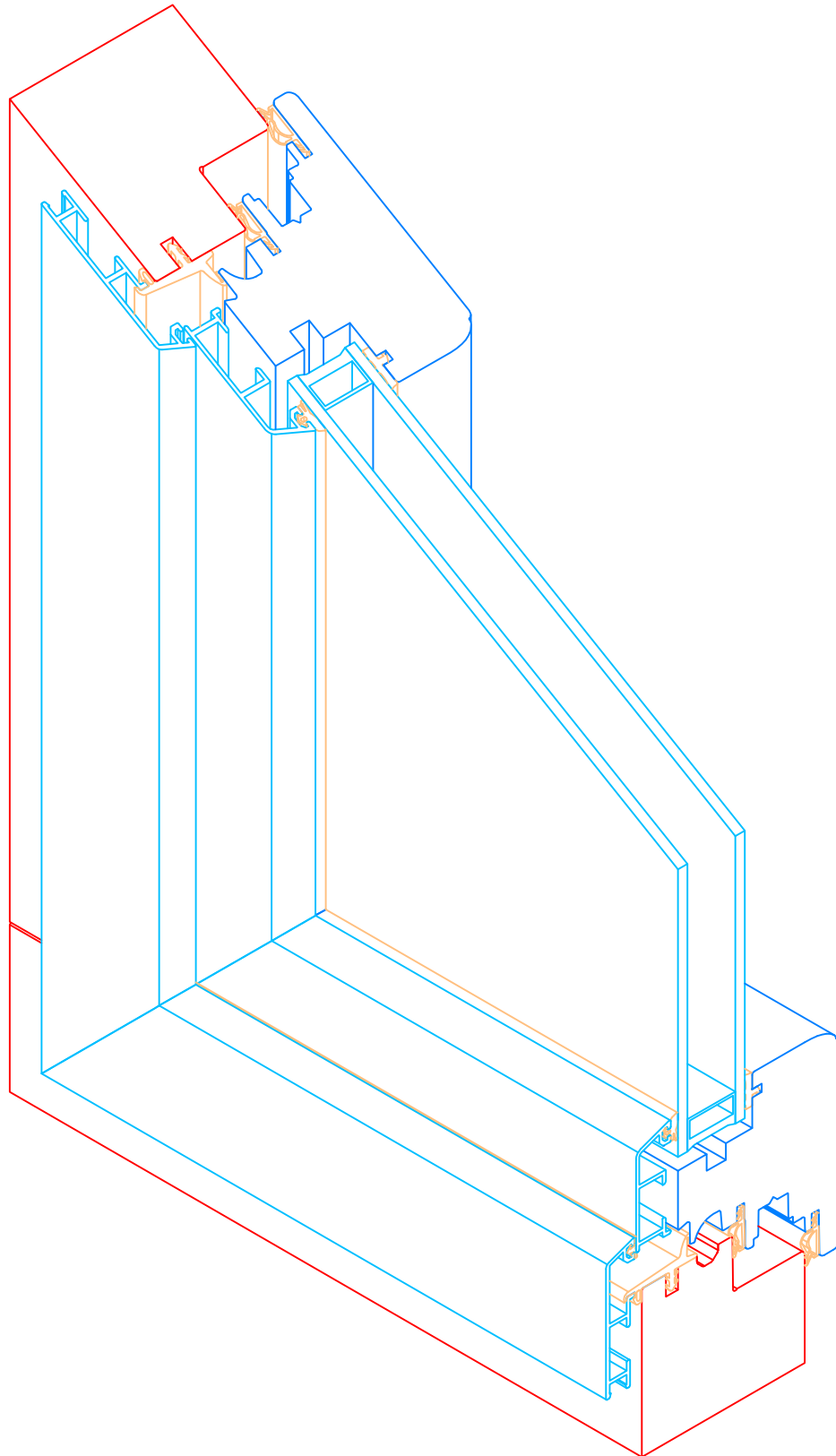















Date	10/10/2019
------	------------







Détails divers	
Typologies de menuiseries	D 01
Profils ouvrants	D 02
Composition des vitrages	D 03
Parcloles	D 04
Petits bois collés	D 05
Poignées	D 06
Dimension cylindre	D 07
Anti-panique	D 08 à D 09
Paumelles	D 10 à D11

Coupes	
Standard	
Vitrage en dormant	C 01 à C 03
Ouvrant	C 04 à C 10
Pièce intermédiaire ouvrant	C 11 à C 12
Meneau	C 13 à C 15
Traverse intermédiaire dormant	C 16 à C 19
Seuil porte-fenêtre	C 20 à C 21
Soubassement de porte-fenêtre	C 22 à C 24
Panneau de soubassement	C 25 à C 28
Coulissant basculant	C 29 à C 33
Ouverture Extérieure	
Ouvrant	C 34 à C 37
Passif	
Vitrage en dormant	C 38 à C 40
Ouvrant	C 41 à C 47
Meneau	C 48 à C 50
Traverse intermédiaire dormant	C 51 à C 54
Seuil PMR	C 55

Mise en oeuvre de pose	
Tapée de doublage intérieure	P 01 à P 02
Tapée de doublage extérieure	P 03
Tapée persienne	P 04
Rénovation	P 05 à P 06
Volet roulant bloc N	P 07 à P 08
Volet roulant bloc Y	P 09 à P 10
Brise soleil orientable	P 11

Détails divers

	Vitrage en dormant
	Ouvrant un vantail
	Ouvrant deux vantaux
	Ouvrant avec petit bois massif vertical
	Ouvrant avec petit bois massif horizontal
	Vitrage en dormant double avec meneau
	Ouvrant double avec meneau
	Ouvrant avec partie latérale fixe
	Vitrage en dormant double avec traverse intermédiaire
	Ouvrant double avec traverse intermédiaire
	Ouvrant avec allège fixe
	Ouvrant avec imposte fixe
	Porte-fenêtre avec seuil PMR
	Porte-fenêtre avec appui bois

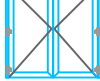
	Porte fenêtre avec seuil PMR et traverses empilées
	Porte-fenêtre avec appui bois et traverses empilées
	Porte-fenêtre avec seuil PMR et panneau de soubassement
	Porte-fenêtre avec appui bois et panneau de soubassement
	Coulissant basculant
	Ouverture extérieur un vantail
	Ouverture extérieur deux vantaux

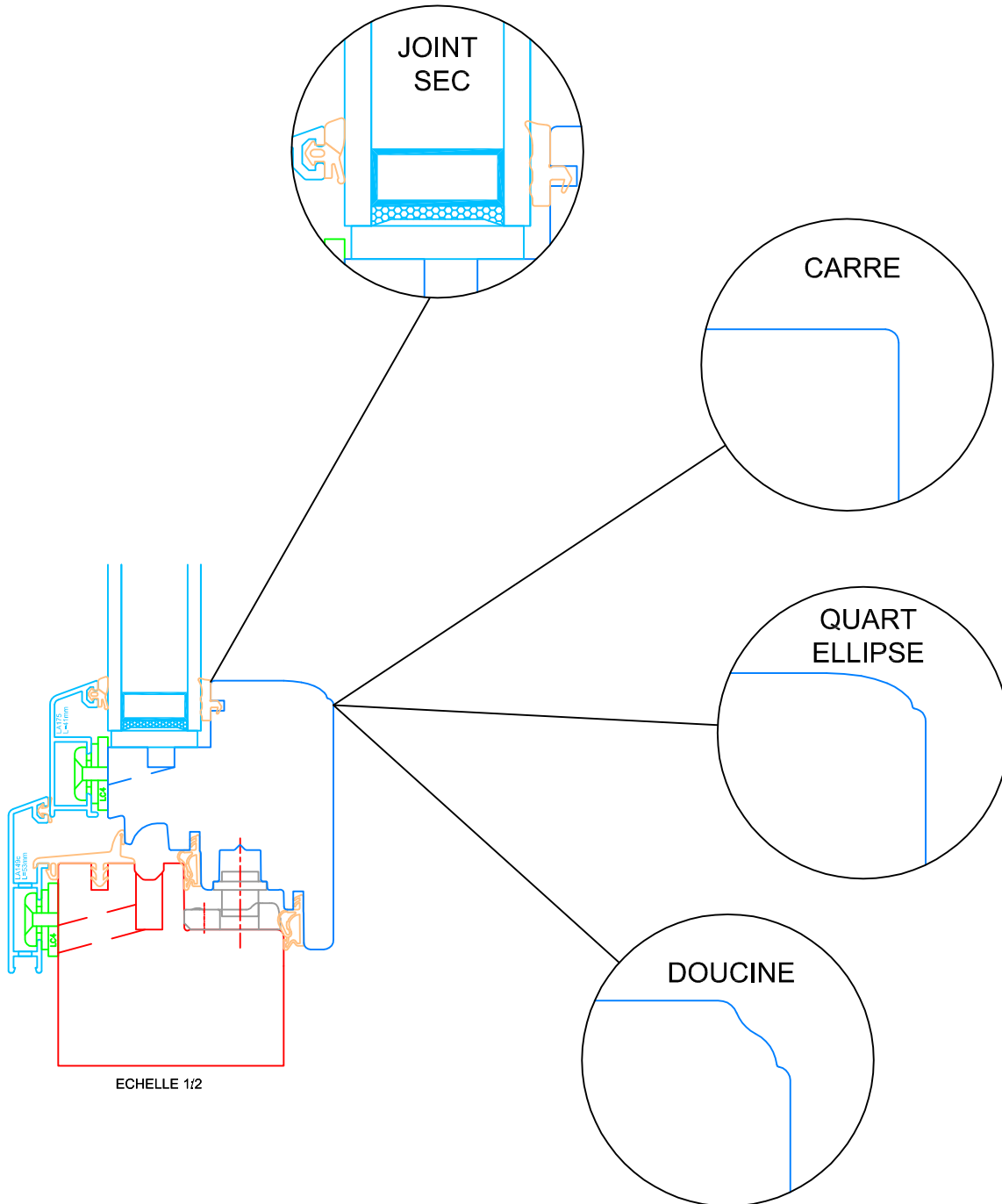

Double Vitrage

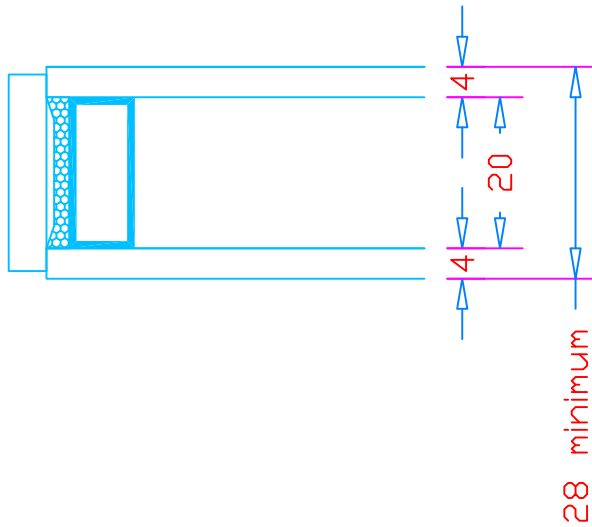

Triple vitrage

Avec joint sec:

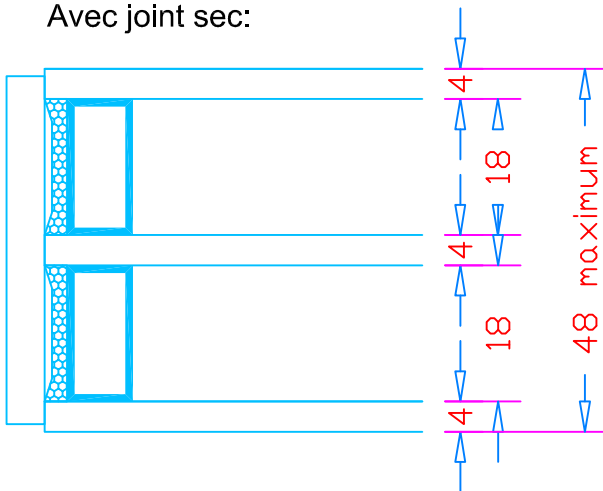

Avec silicone:

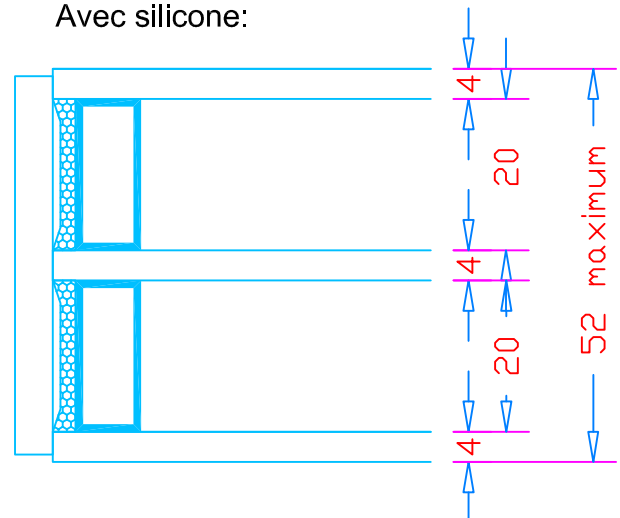

La gamme UNI 8 peut accueillir des vitrage allant de 28 à 48 mm (jusqu'à 52 mm en version silicone).



En standard, la composition du double vitrage est 4/20/4 et en triple vitrage 4/18/4/18/4.

En double vitrage il est possible d'intégrer des vitrages feuilleté 44² ou 66², attention la largeur d'intercalaire sera réduite d'autant.

La largeur minimale d'intercalaire est de 10mm.

Parclose 37 mm (Pour vitrage de 28mm)

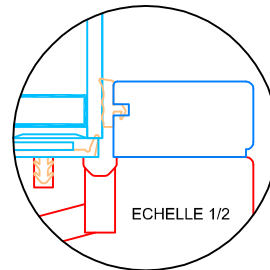
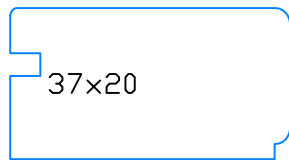
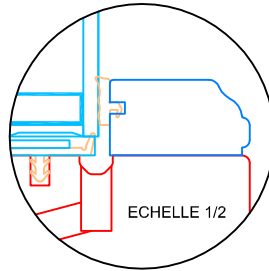
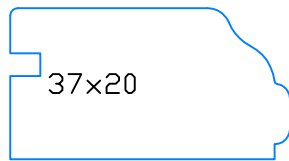
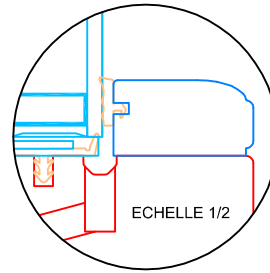
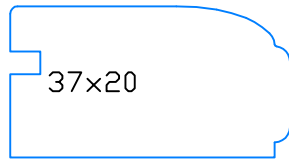

Parclose 17 mm (Pour vitrage de 48 mm)

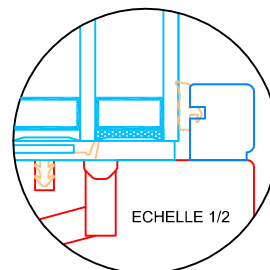
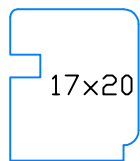
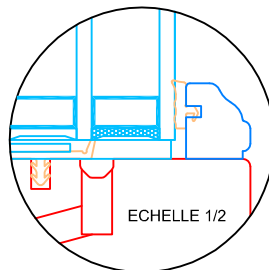
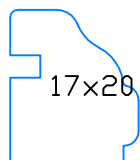
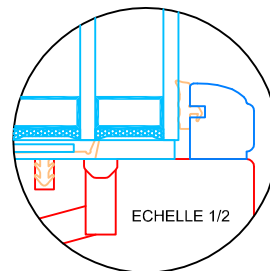
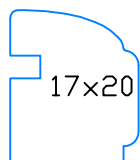

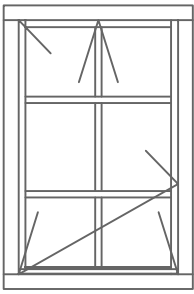

Quart ellipse



Il n'existe pas de petit bois collé avec un profil quart ellipse. Il faut associer le profil de l'ouvrant quart ellipse avec un petit bois collé profil pente.

PENTE

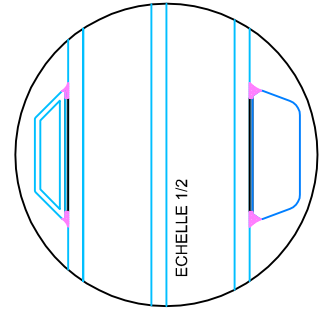
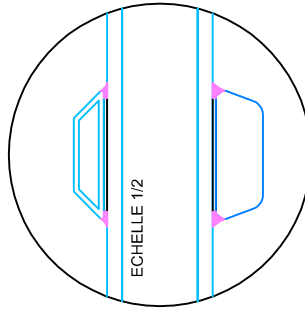
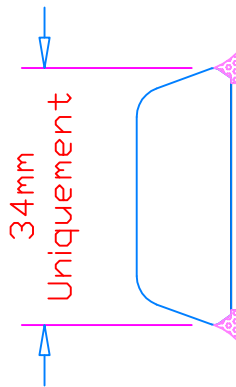

DOUCINE

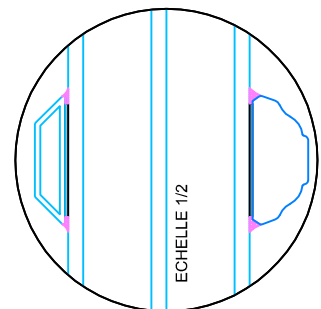
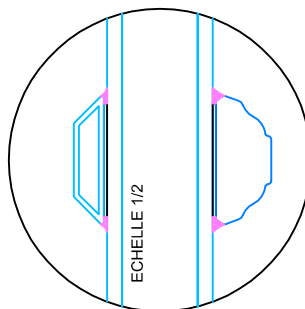
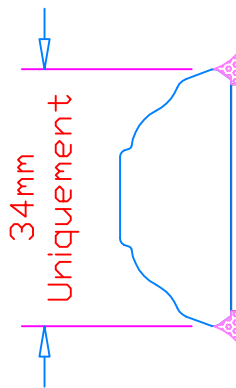

HOPPE ATLANTA

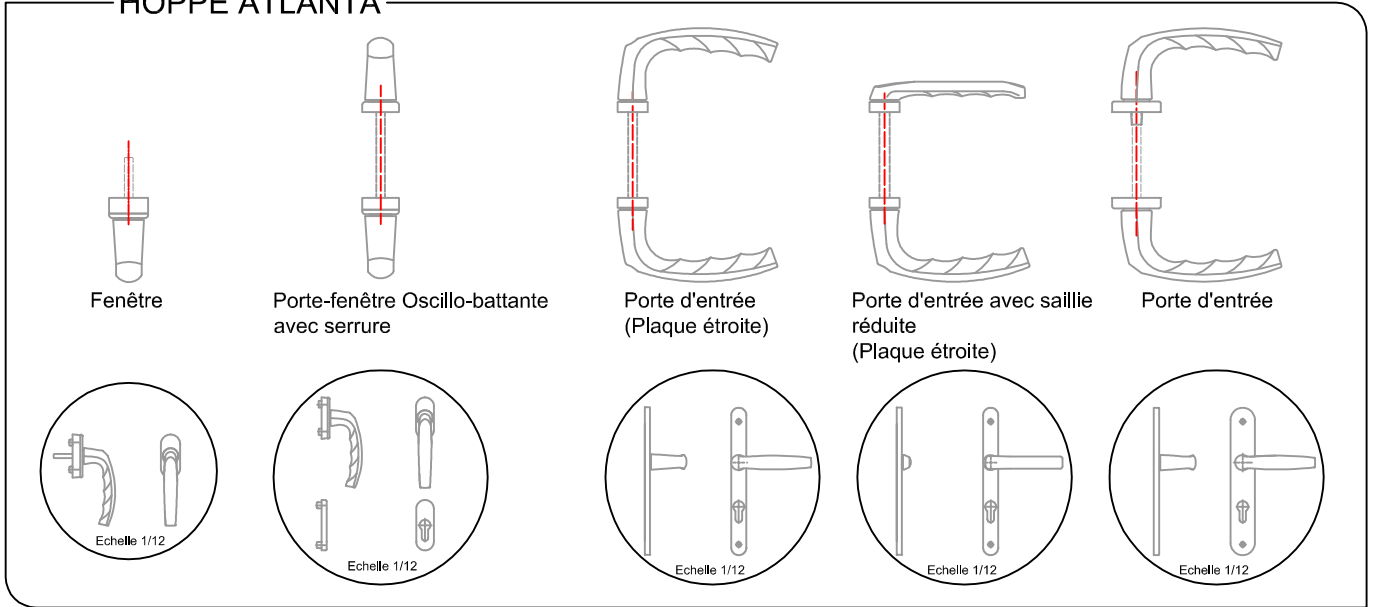

BRIONNE ENTRAYGUES

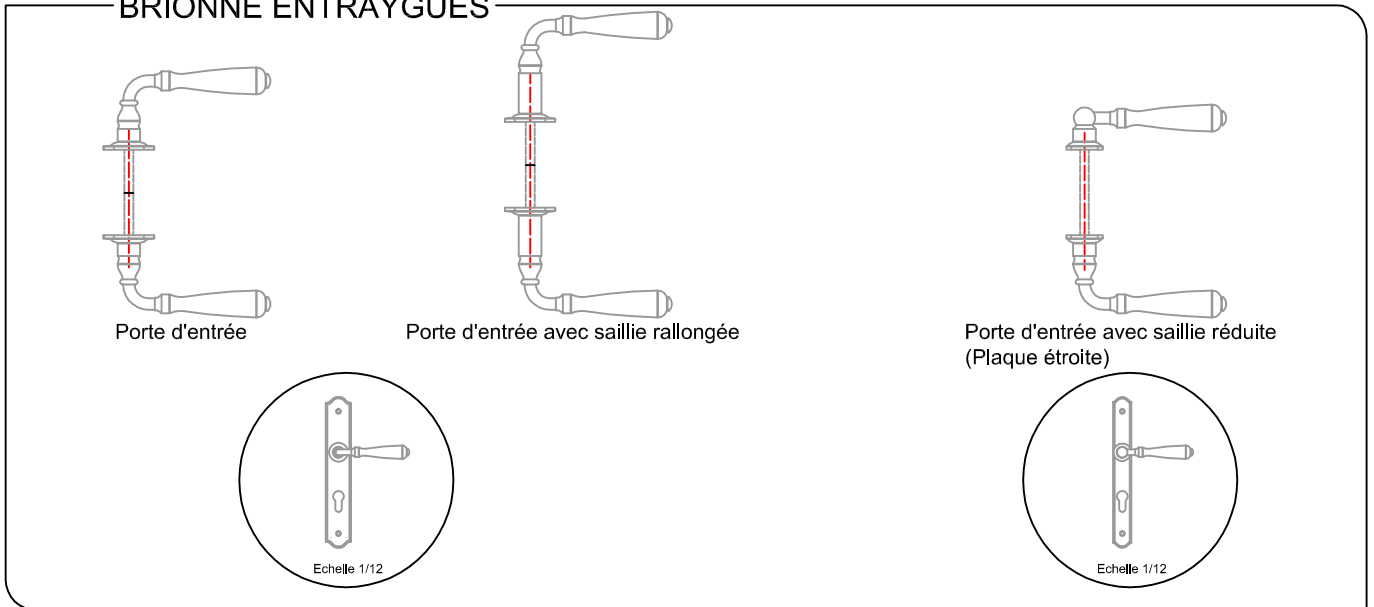

NORMBAU

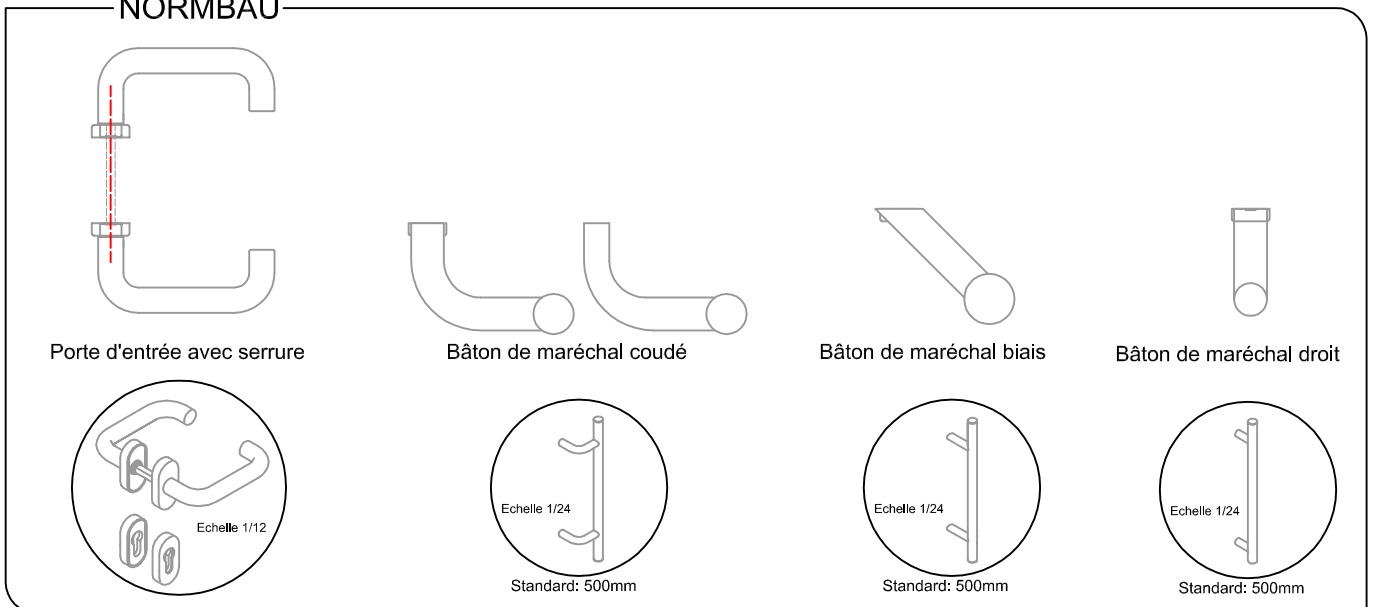

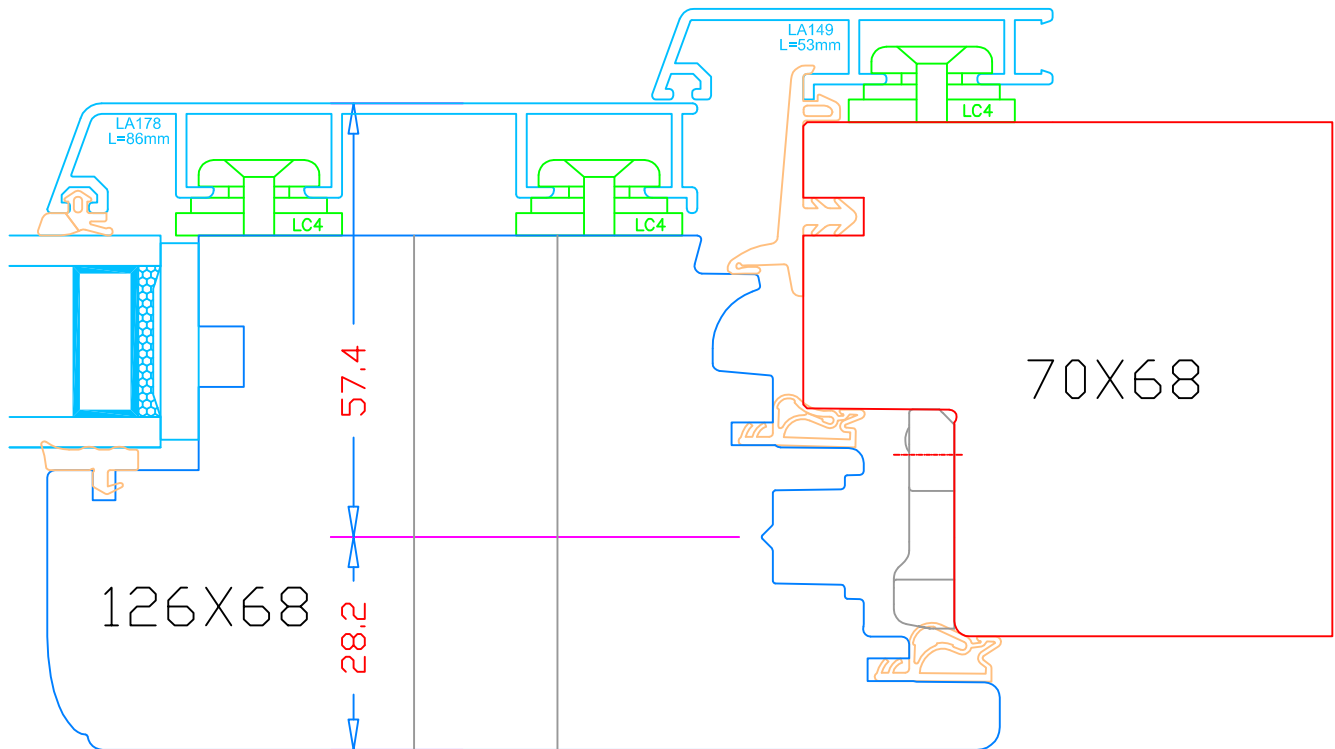

Ouverture intérieure

Dimension de cylindre (EXT/INT)			
	Atlanta	Enraygues	Normbau
UNI 8	70/40	60/35	70/40

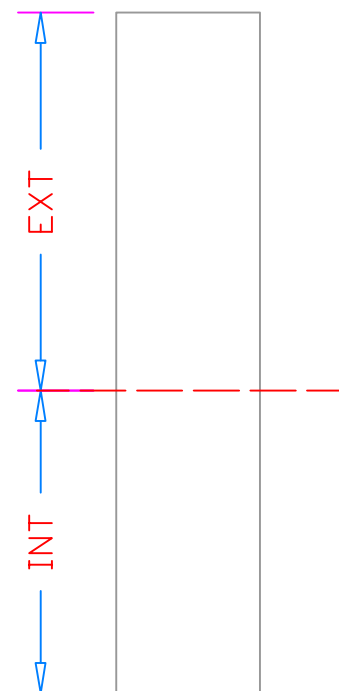

Ouverture extérieure

Dimension de cylindre (EXT/INT)			
	Atlanta	Enraygues	Normbau
UNI 8	50/50	45/45	55/55

Module extérieur en option

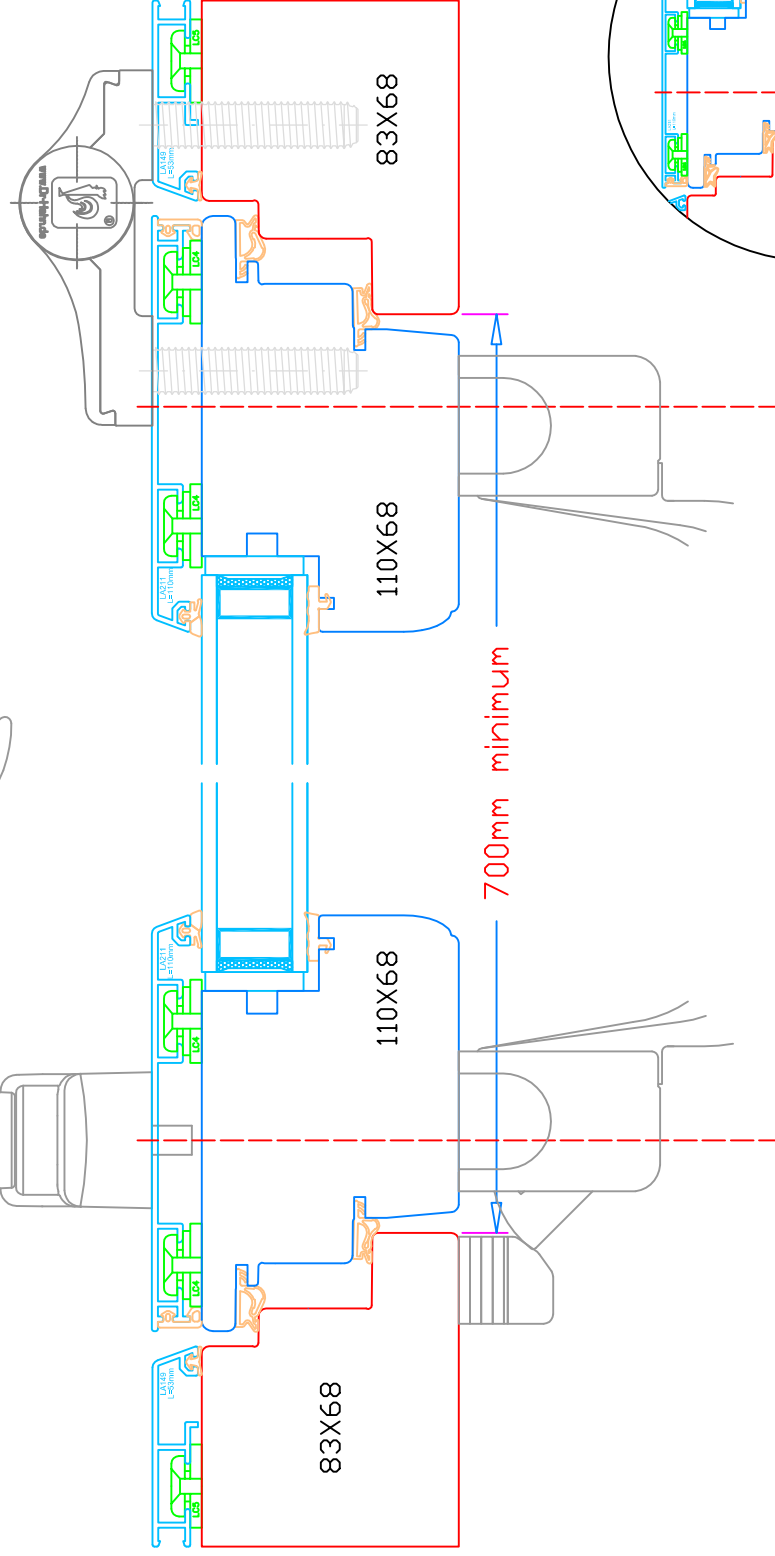
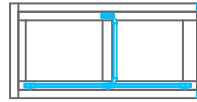

PASSAGE

Attention, le passage entre les montants du dormant doit être de 700 mm au minimum.

Module extérieur en option

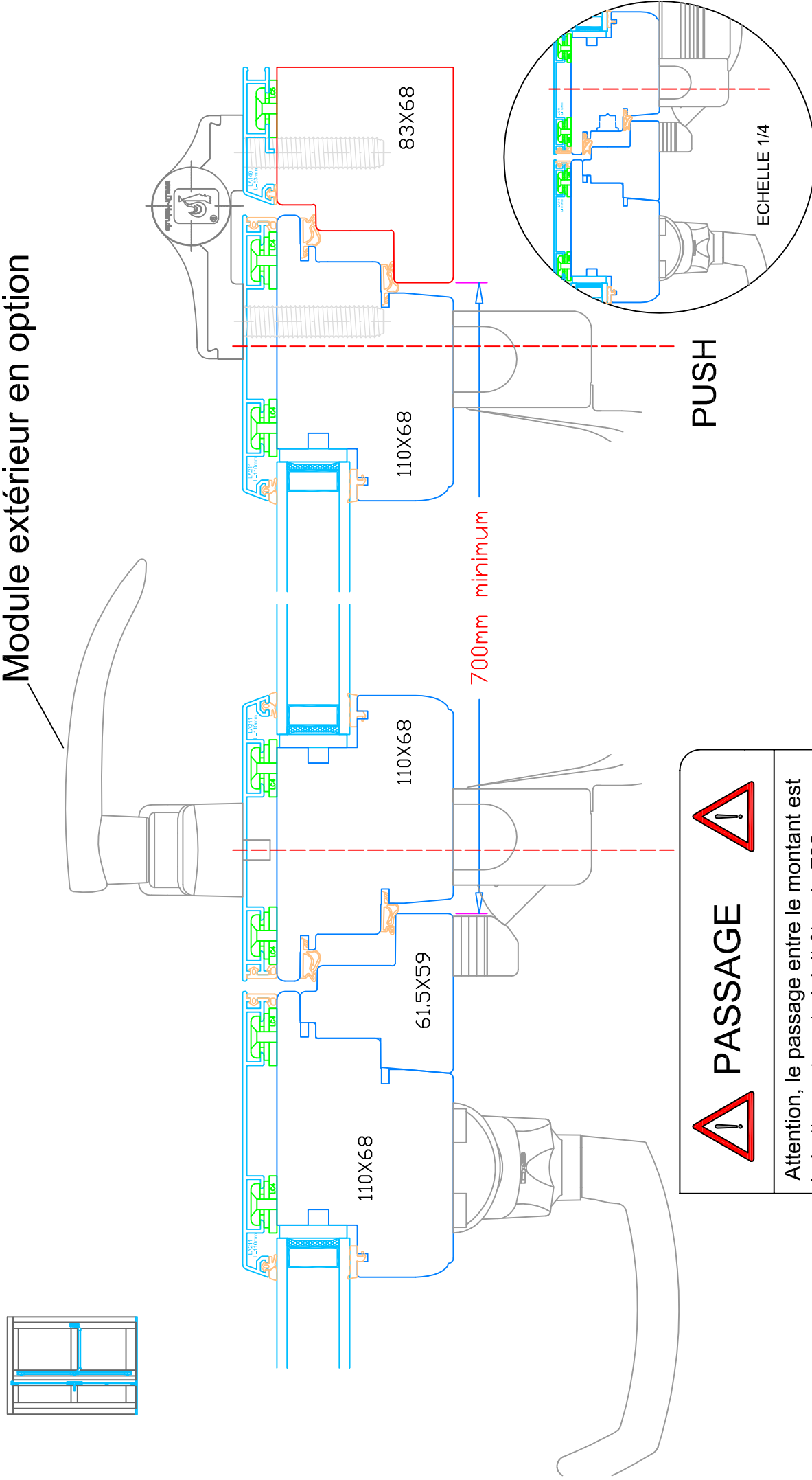

⚠ PASSAGE ⚠

Attention, le passage entre le montant est le battent central doit être de 700 mm au minimum.

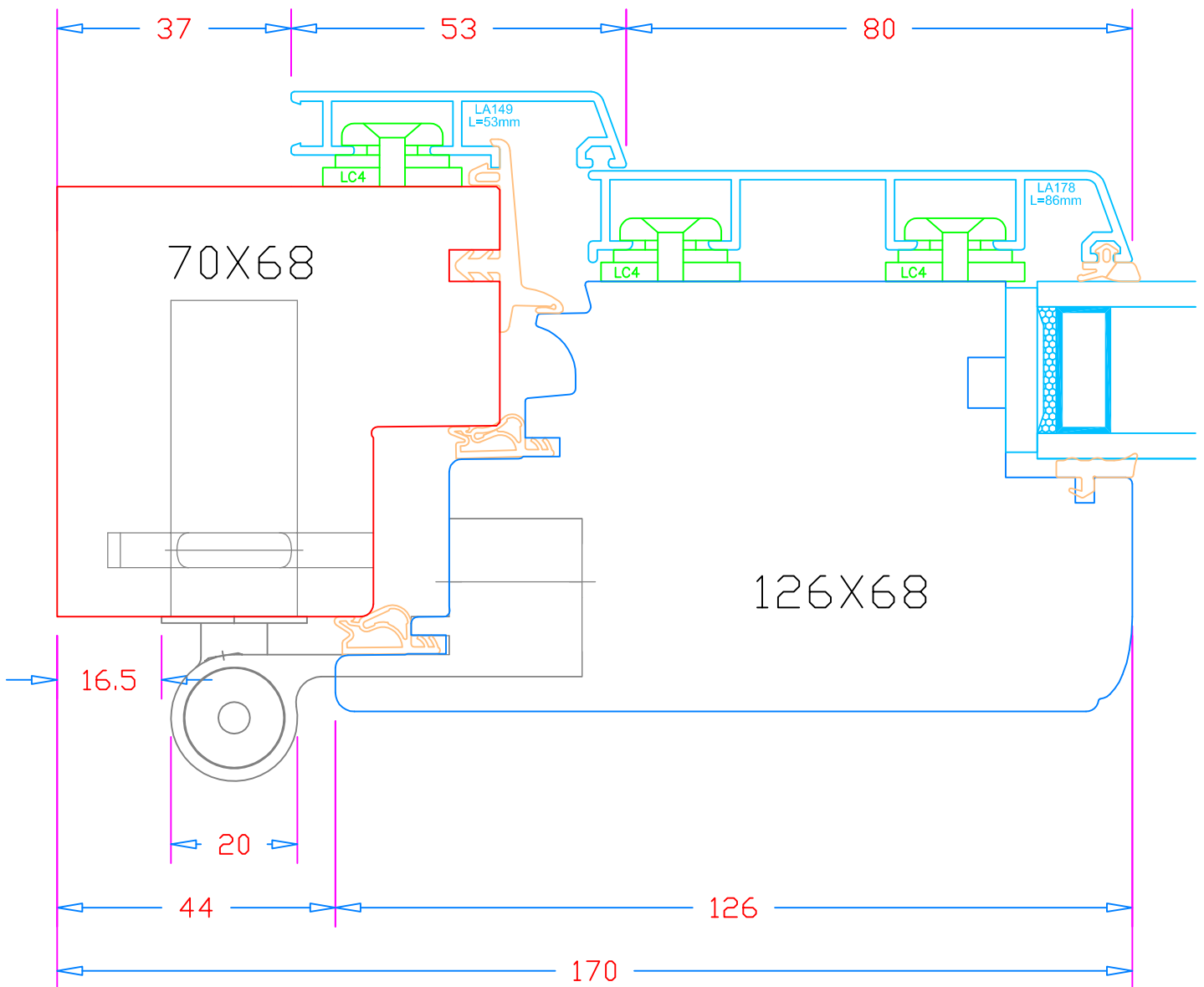
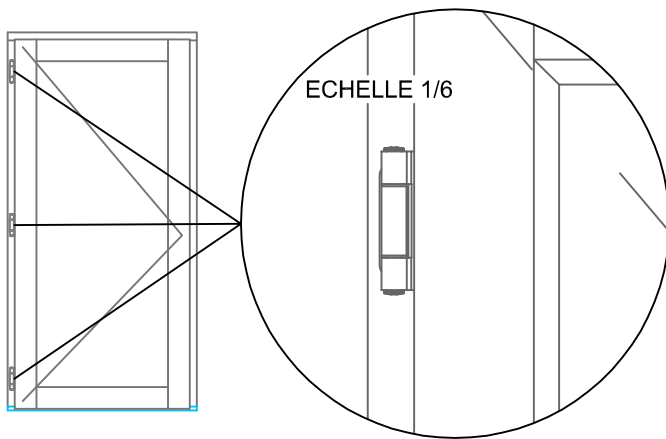

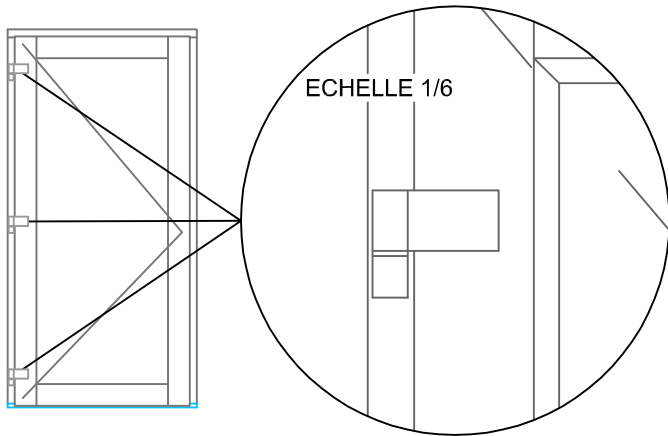

DEGONDAGE



Attention, en partie haute, il faut prévoir un jeu de 47 mm au dessus de l'ouvrant, pour pouvoir dégonder l'ouvrant.

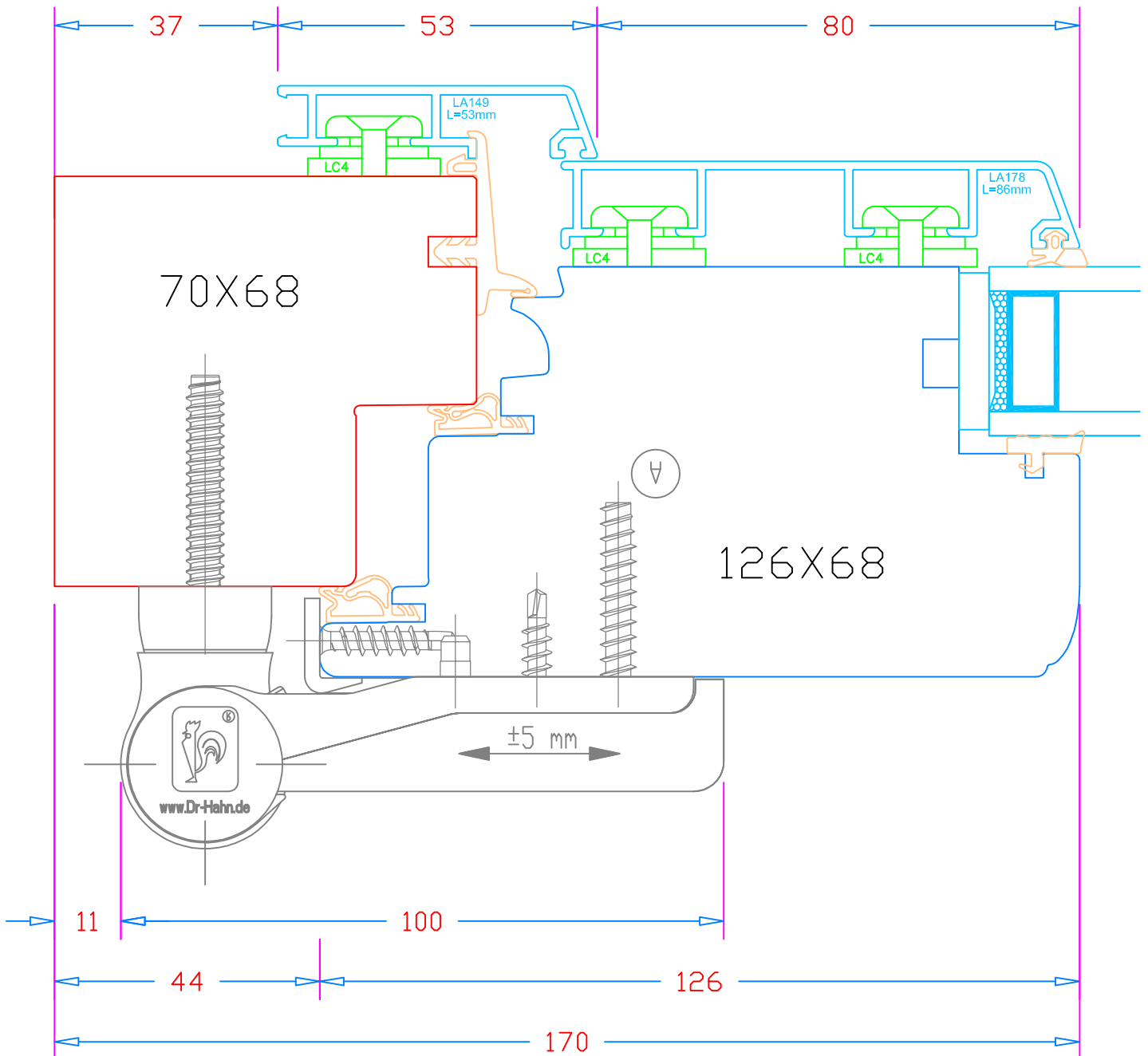

Coupes Standard

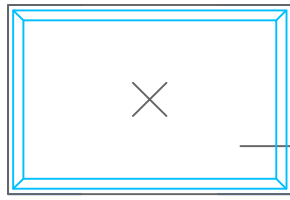

Coupe 01

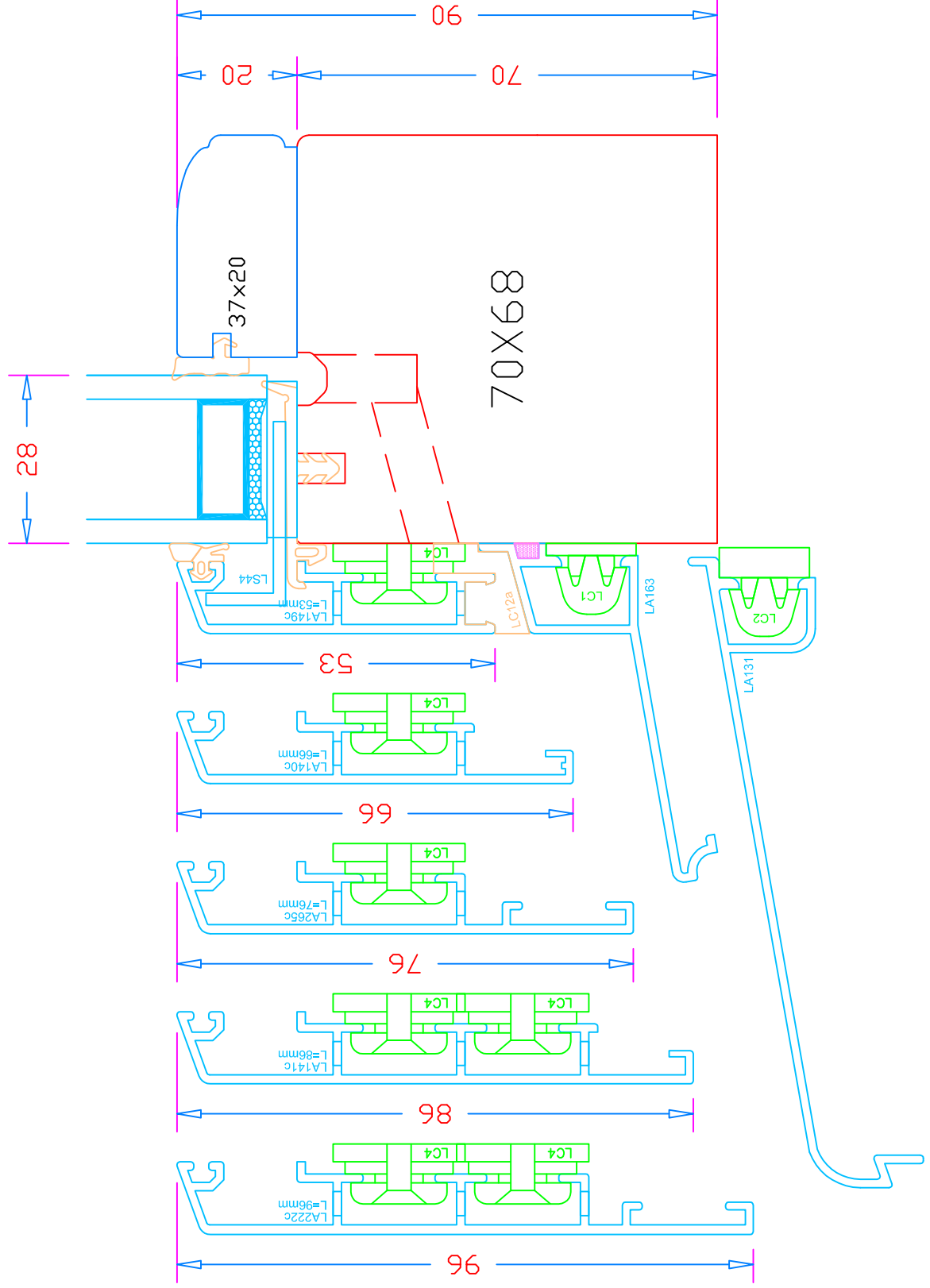

Coupe 02

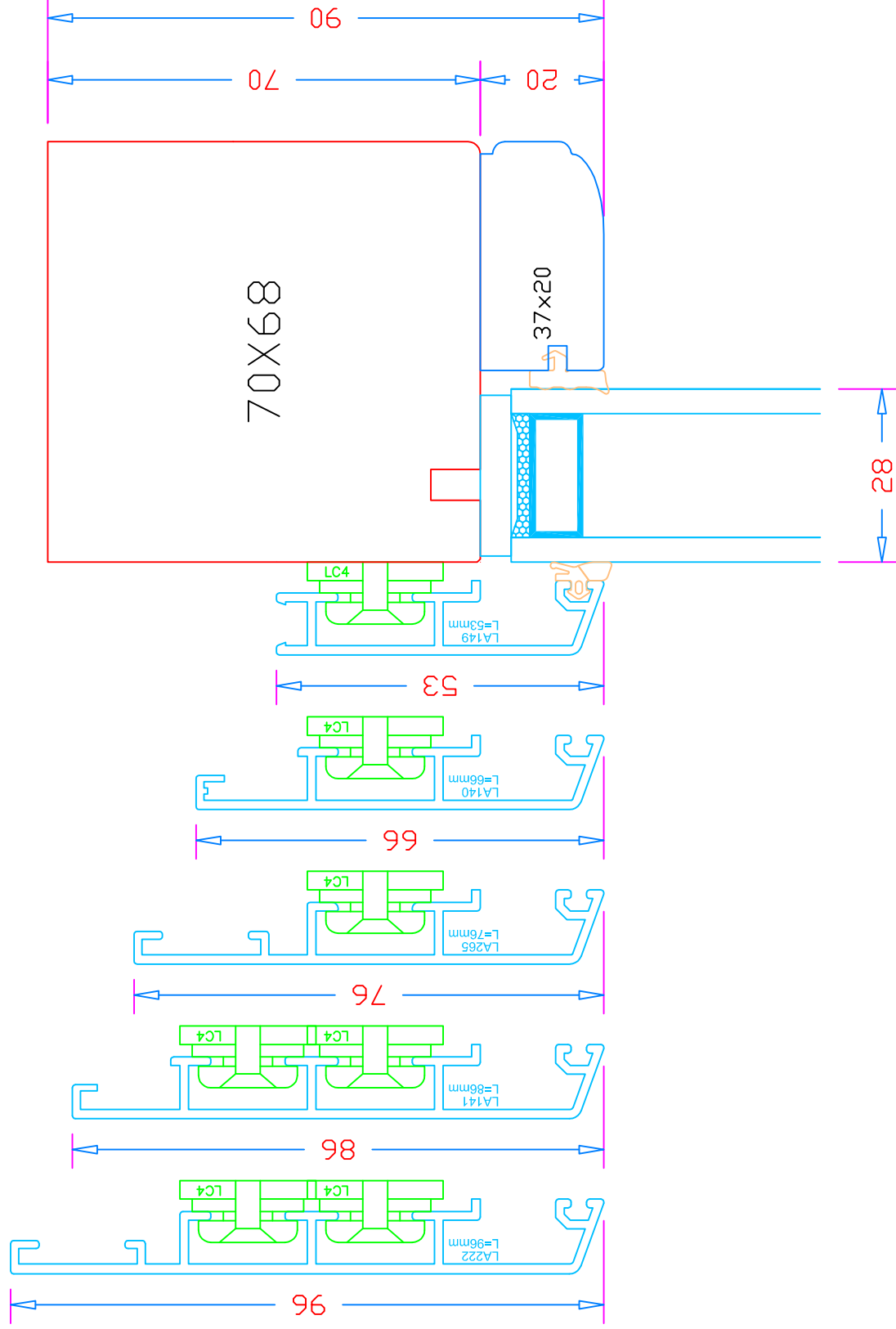
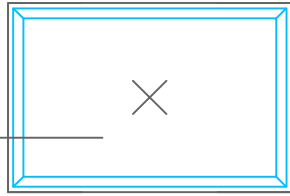

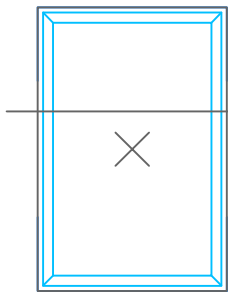

Coupe 03
 Vue Intérieure

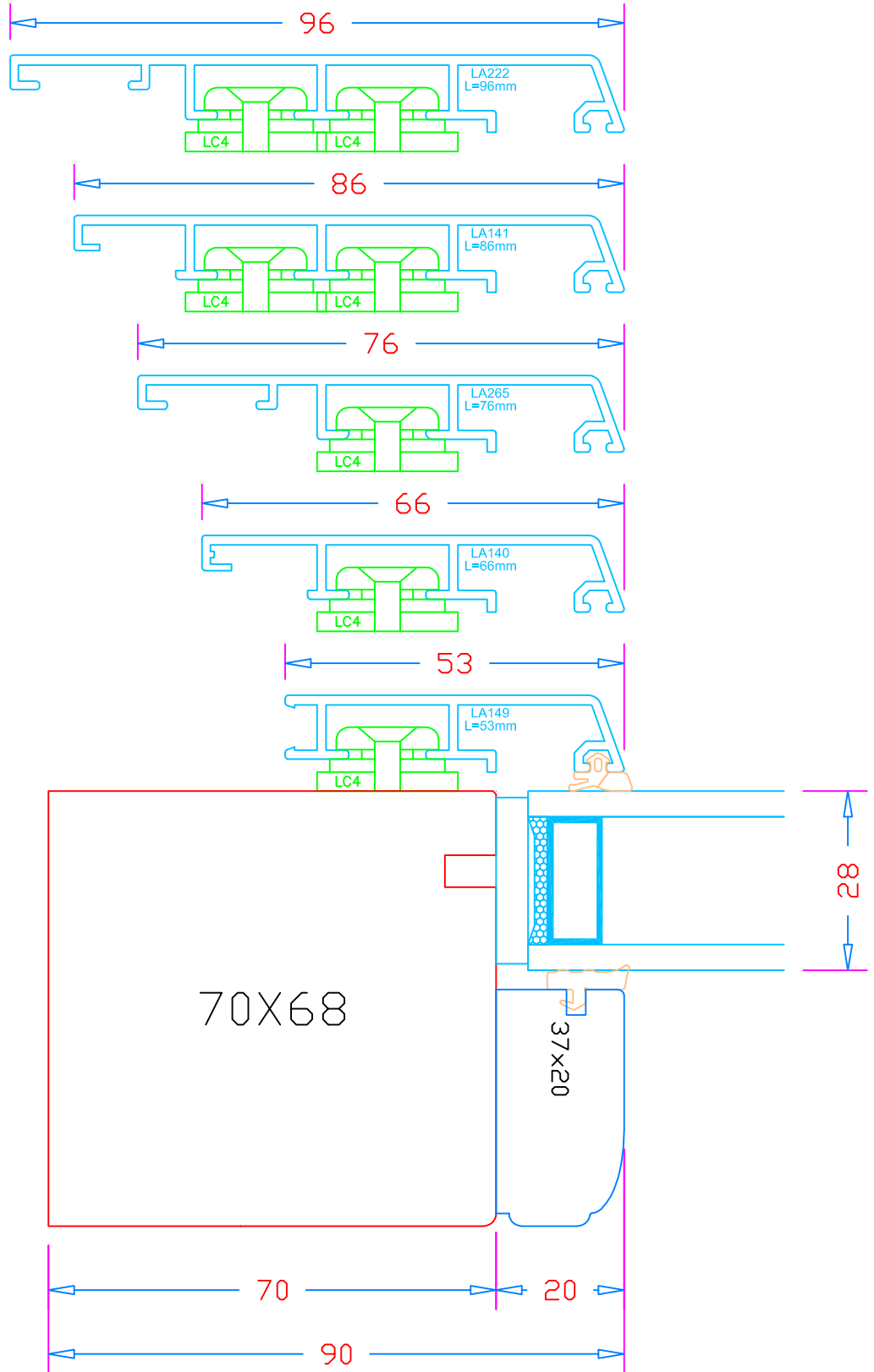

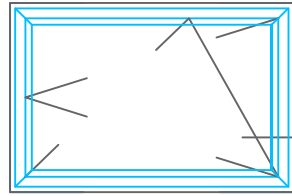

Coupe 04a

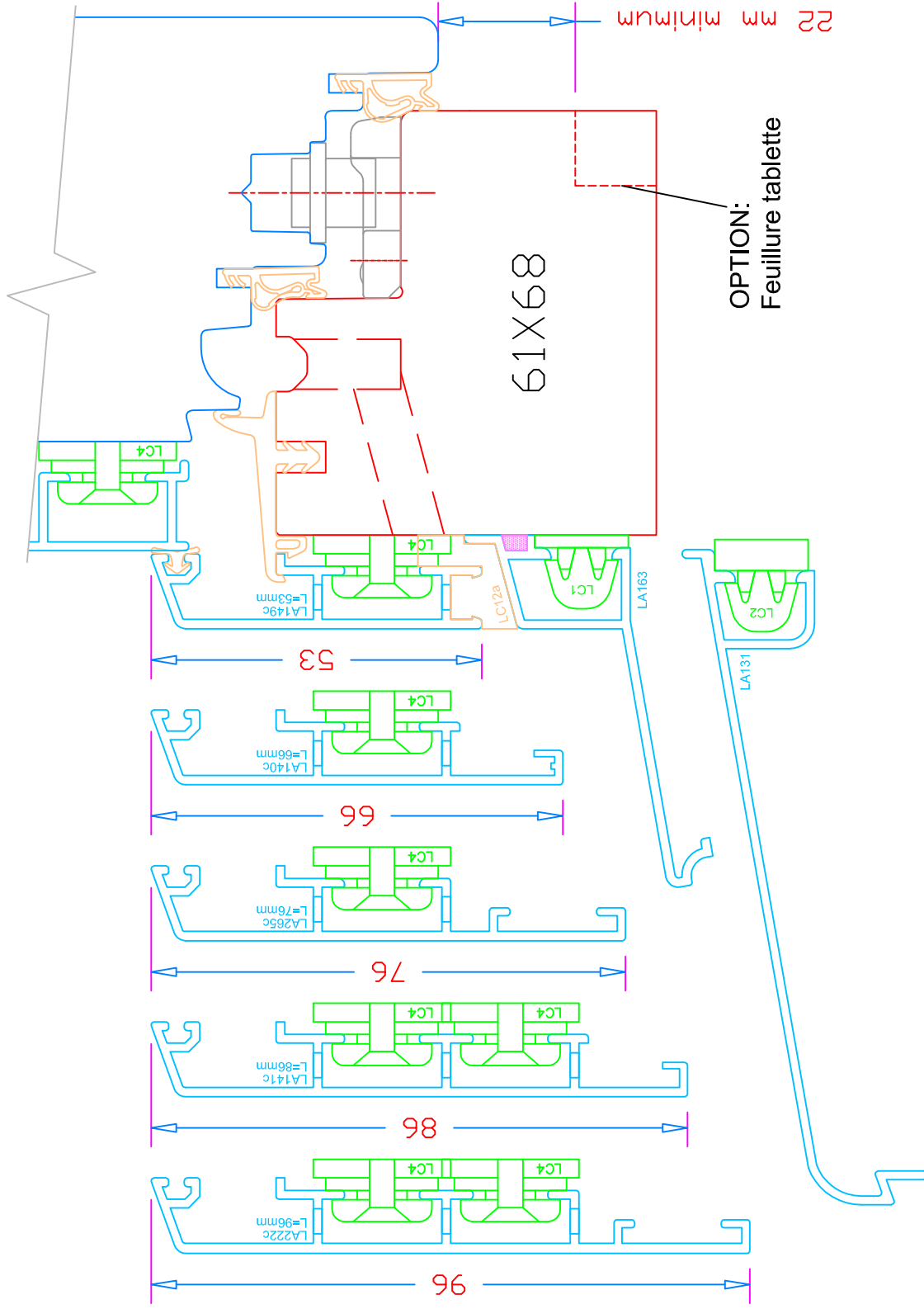

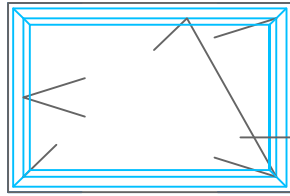

Coupe 04b

Largeur possible de bavette

50mm	150mm	225mm	320mm
70mm	165mm	240mm	360mm
90mm	180mm	260mm	400mm
110mm	195mm	280mm	
130mm	210mm	300mm	

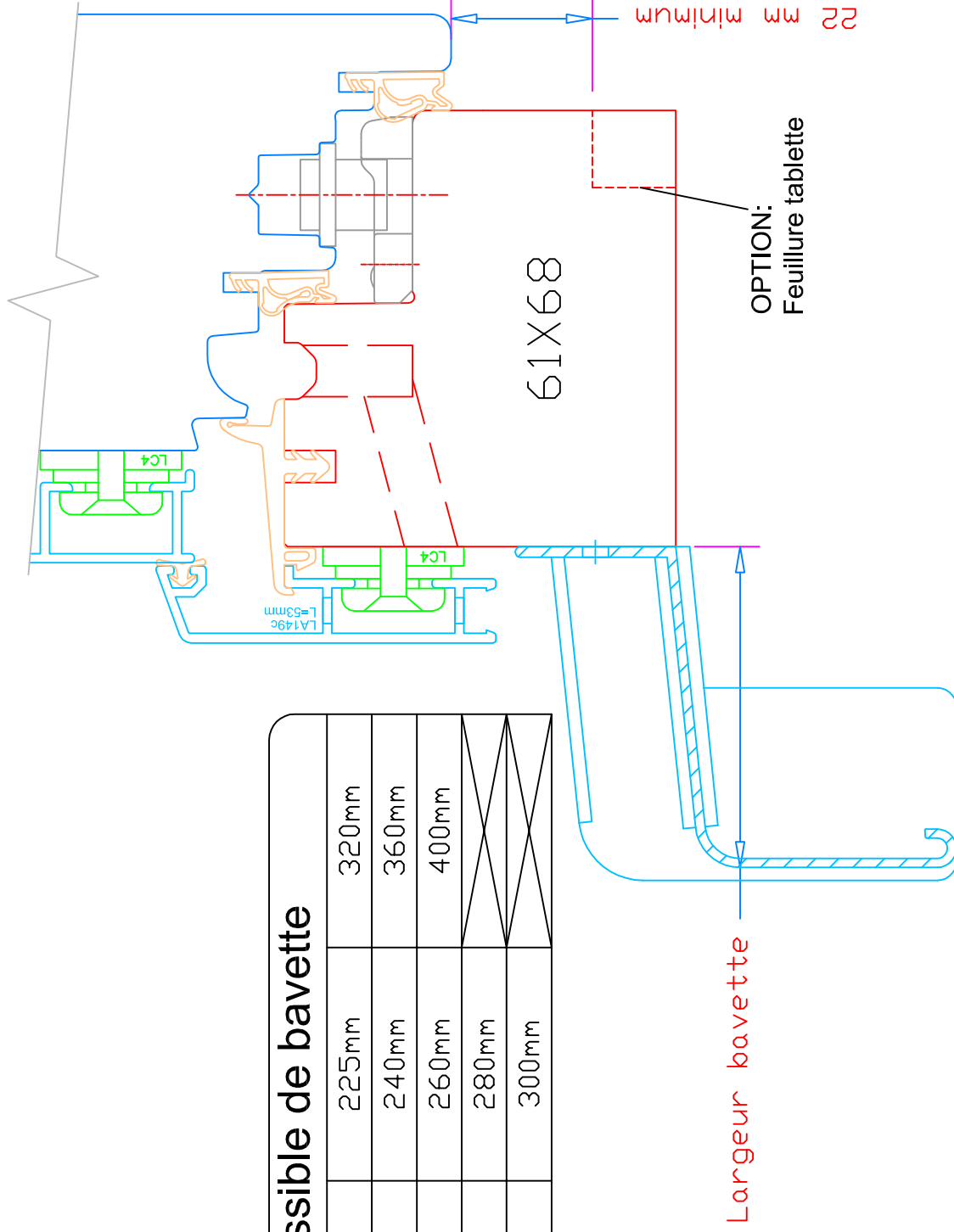

Ouvrant
Traverse basse feuillure rénovation (Détail du dormant)

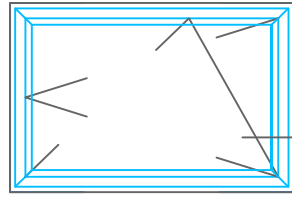

Coupe 04c

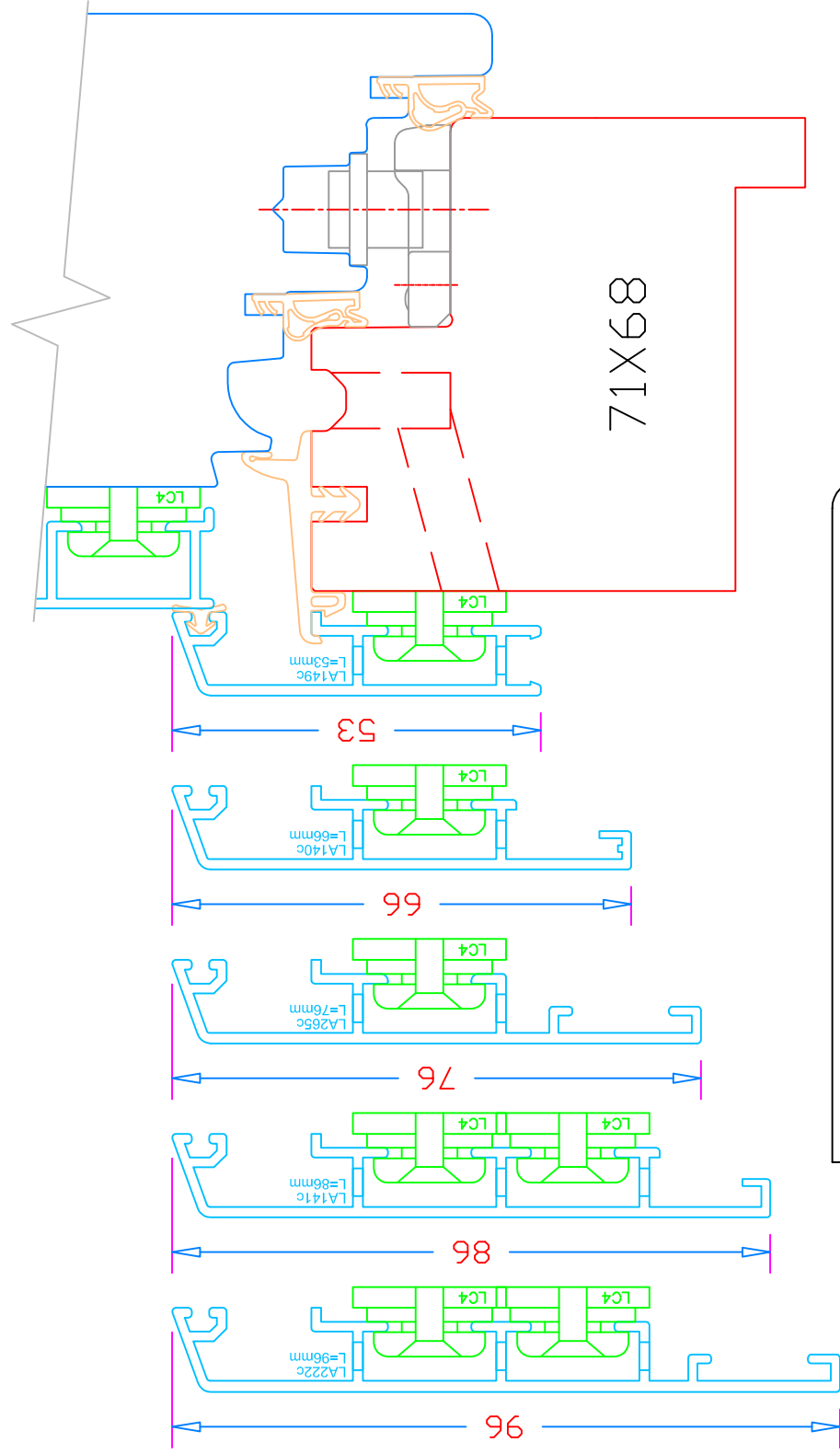

⚠ Feuillure rénovation ⚠

La feuillure rénovation est définie en fonction de la pose du chanteret et du profil aluminium utilisé. Faire une demande de faisabilité.

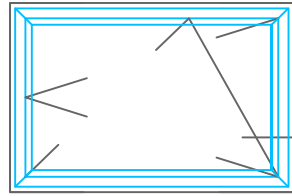

Coupe 04d

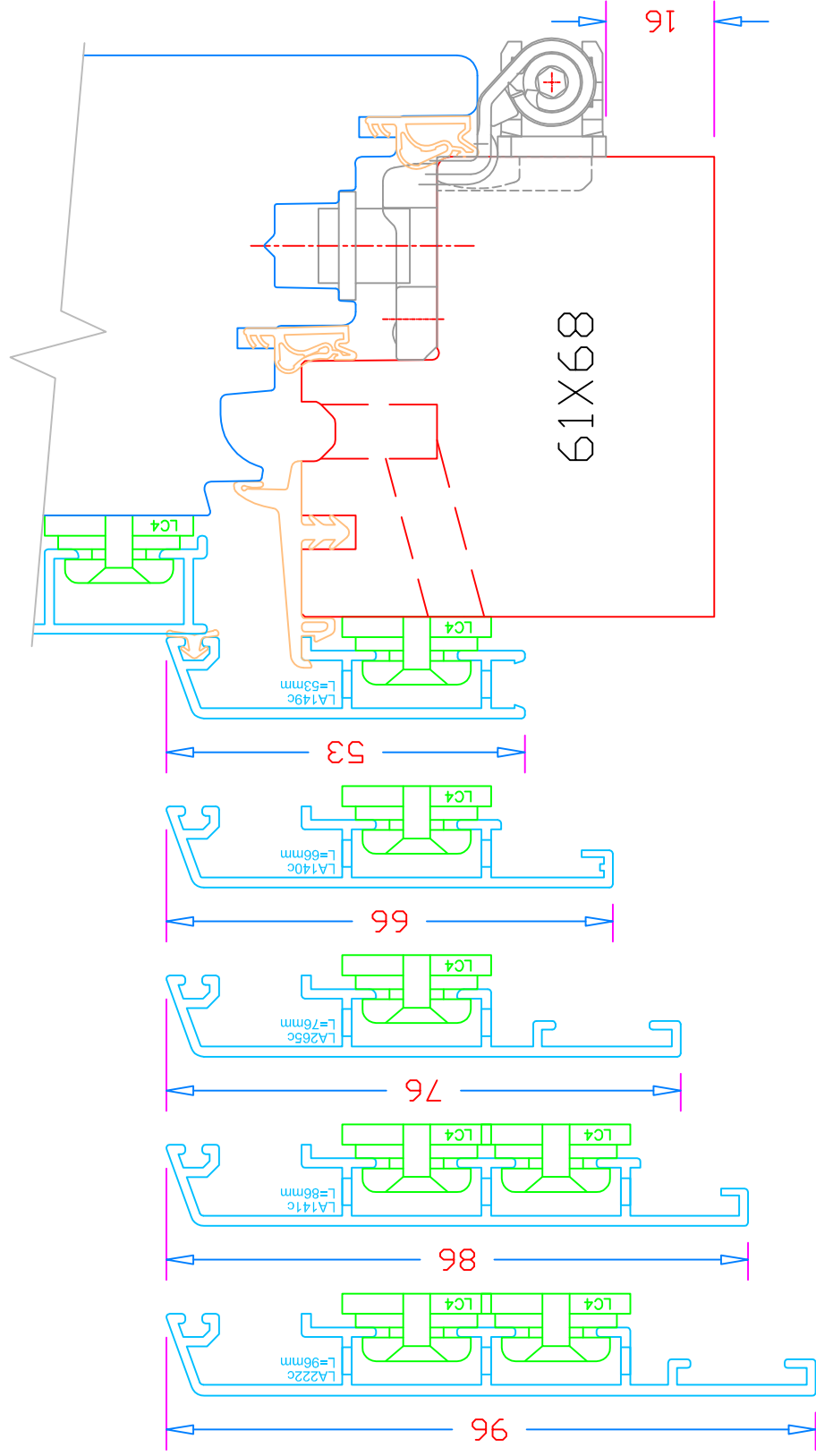

Coupe 05a

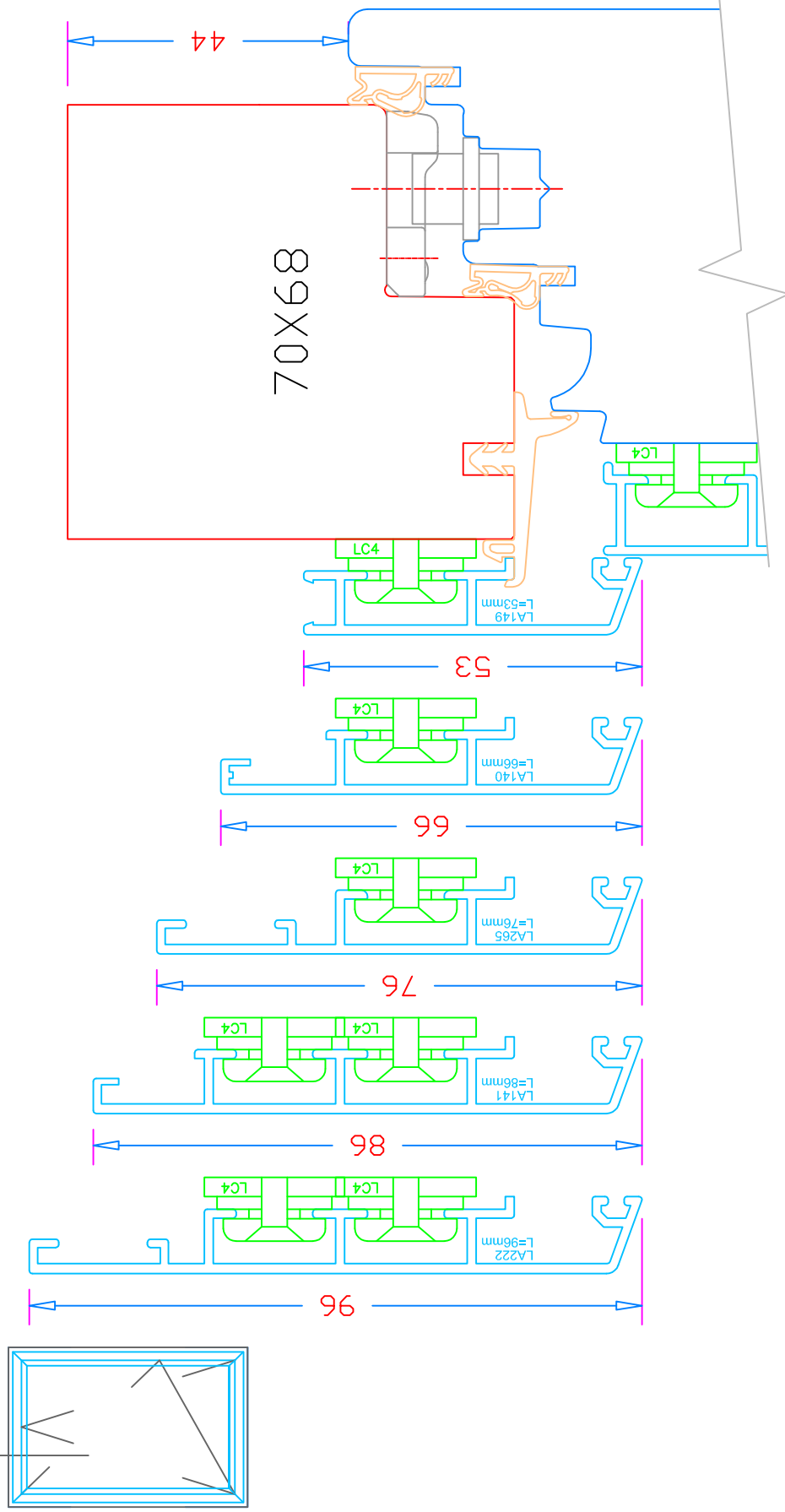

Ouvrant soufflet
Traverse haute avec ferme-imposte (Détail du dormant)

Coupe 05b

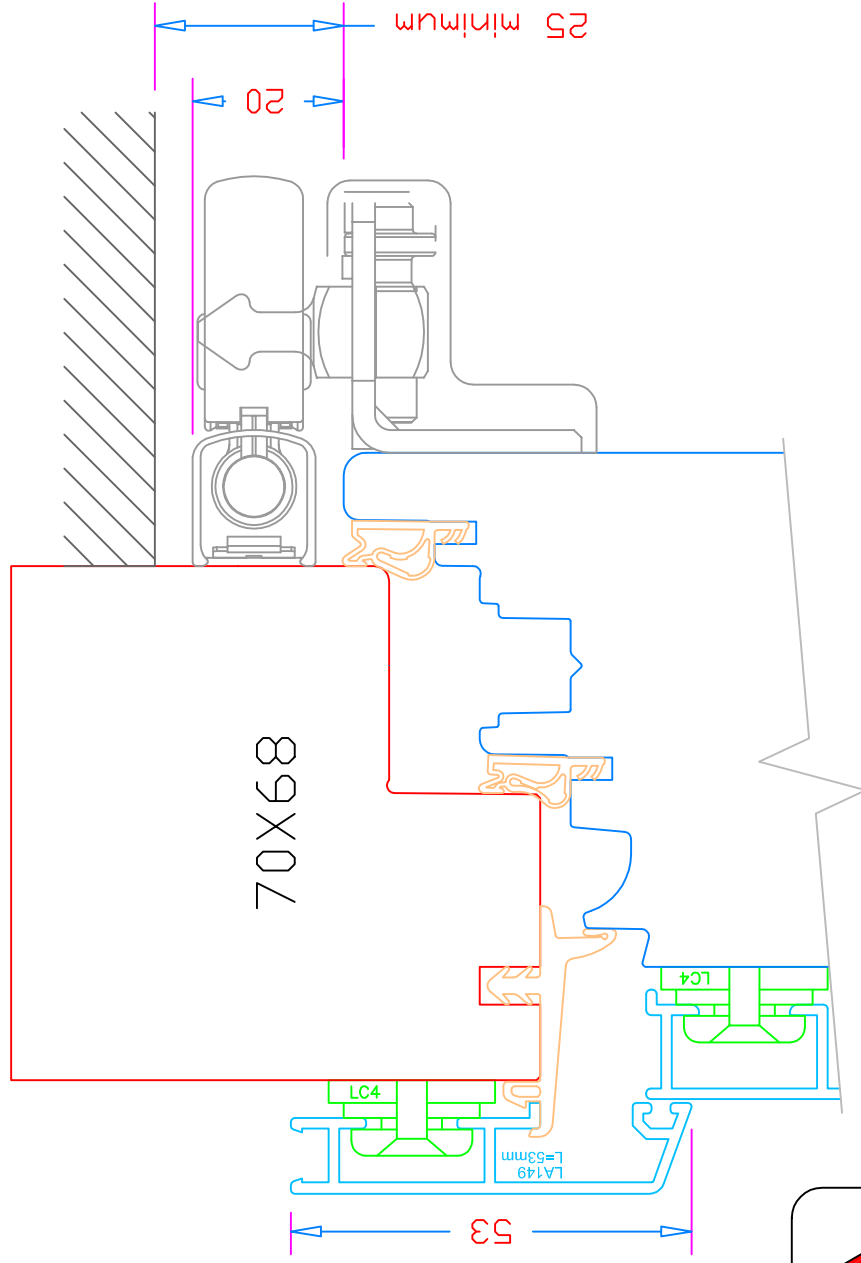
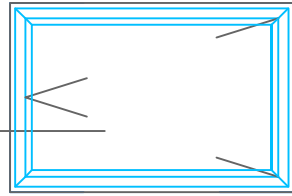

Pour les autres
profils aluminium
voir coupe C05a



ENCOMBREMENT

Attention, il faut prévoir un encombrement minimum de 25 mm entre le joue de l'ouvrant et le retour du tableau pour permettre le passage du ferme-imposte.

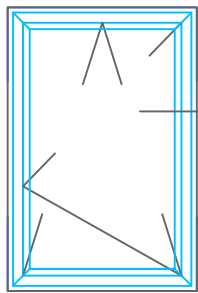

Coupe 06a
 Vue Intérieure

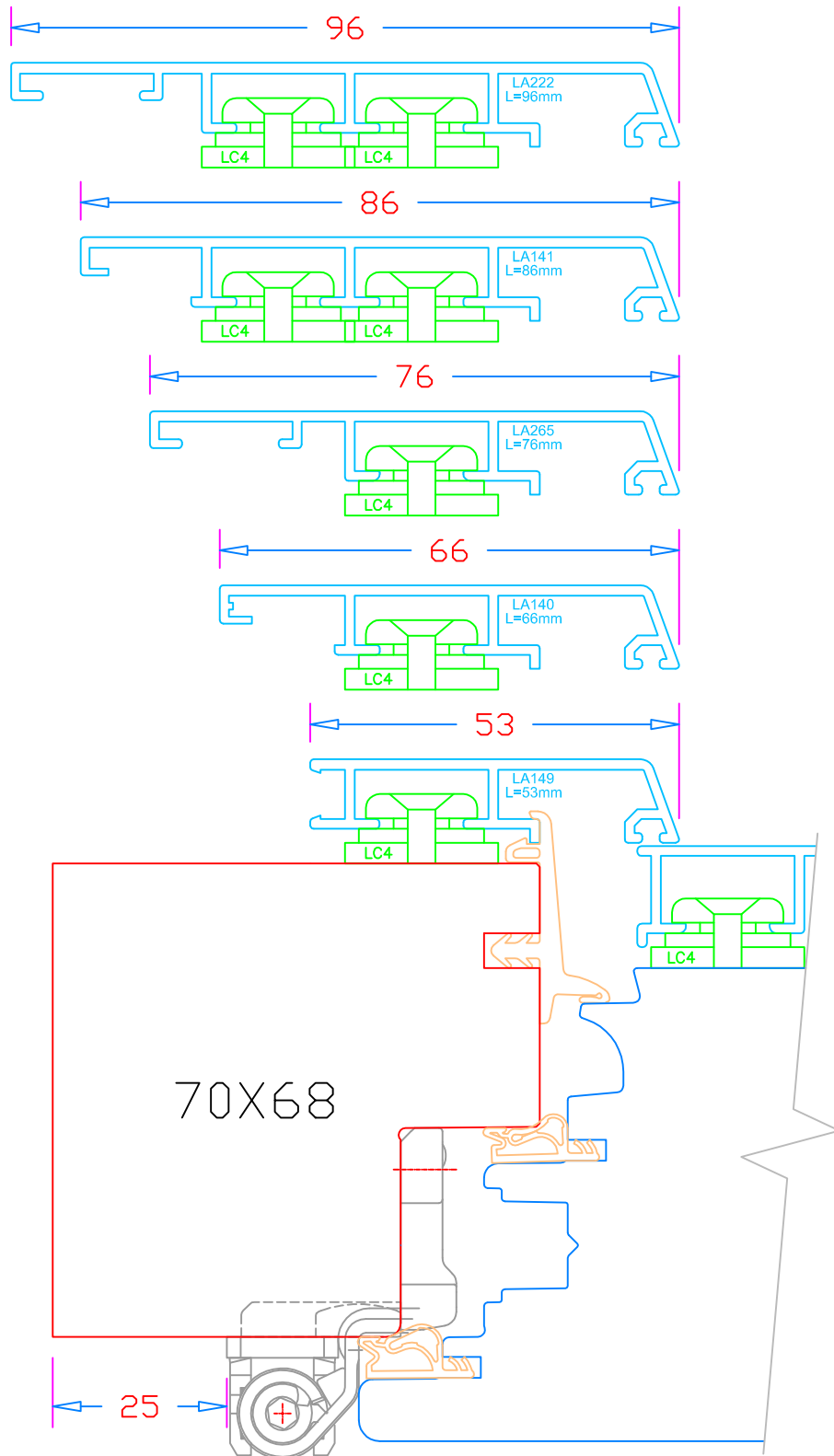

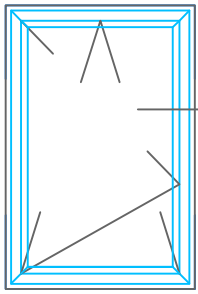

Coupe 06b
 Vue Intérieure

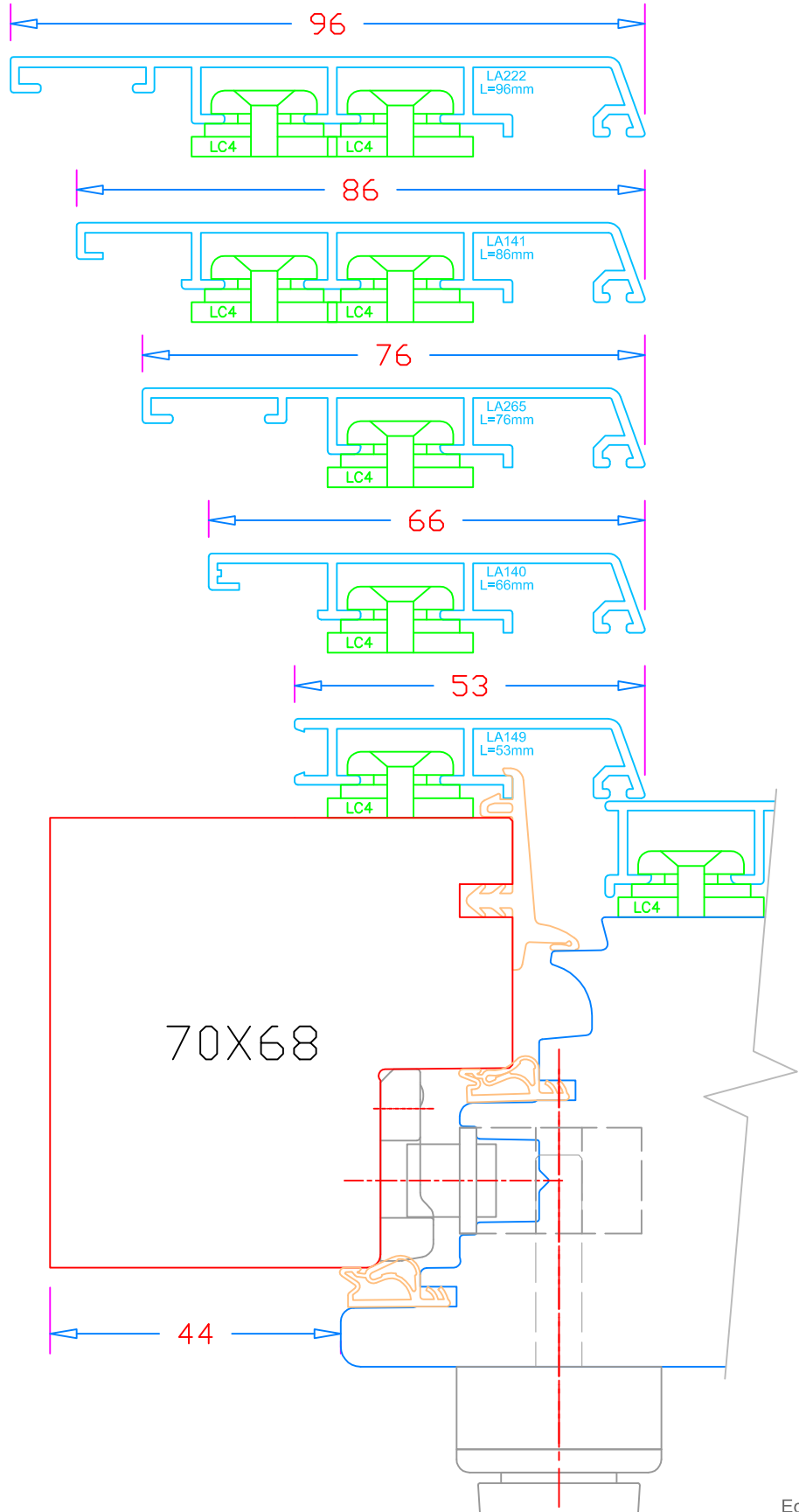

Ouvrant
Traverse basse (Détail de l'ouvrant)

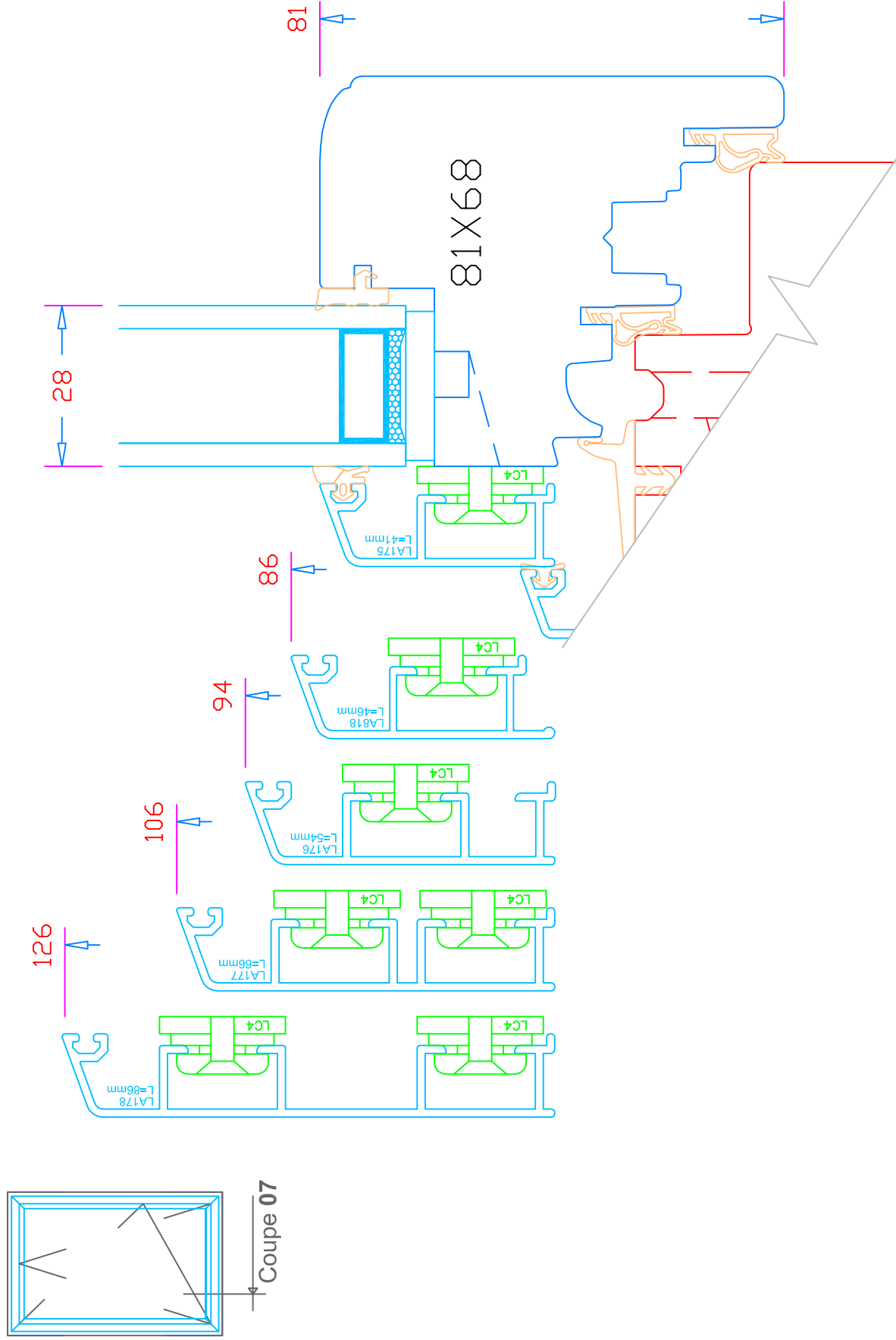

Coupe 08a

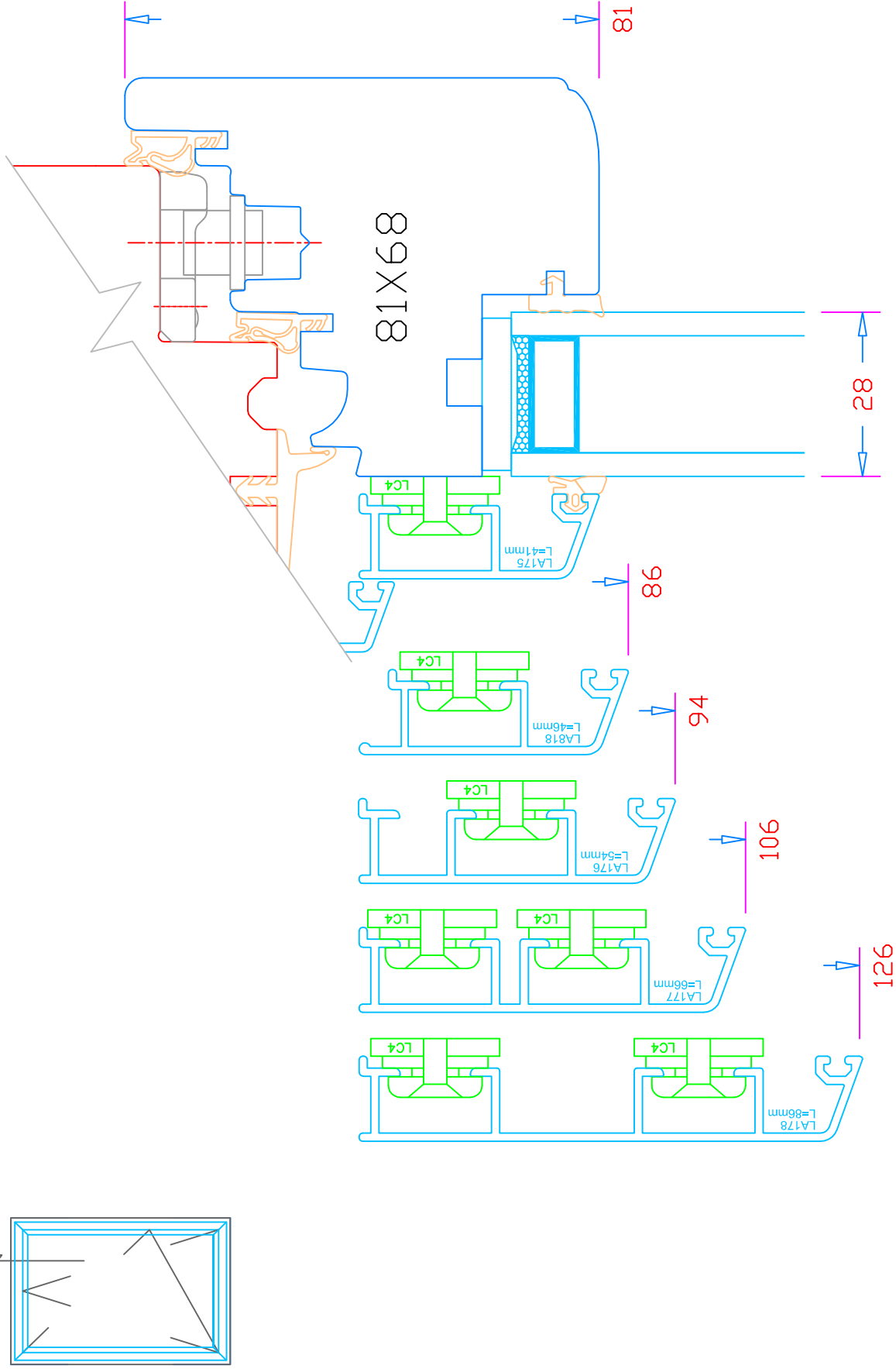

Coupe 08b

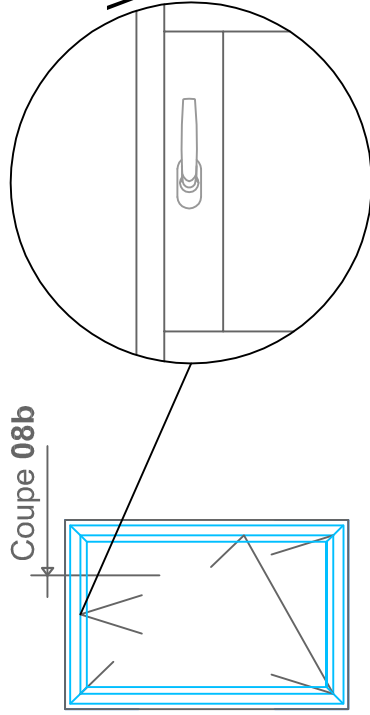

Vue intérieure

Position de la poignée

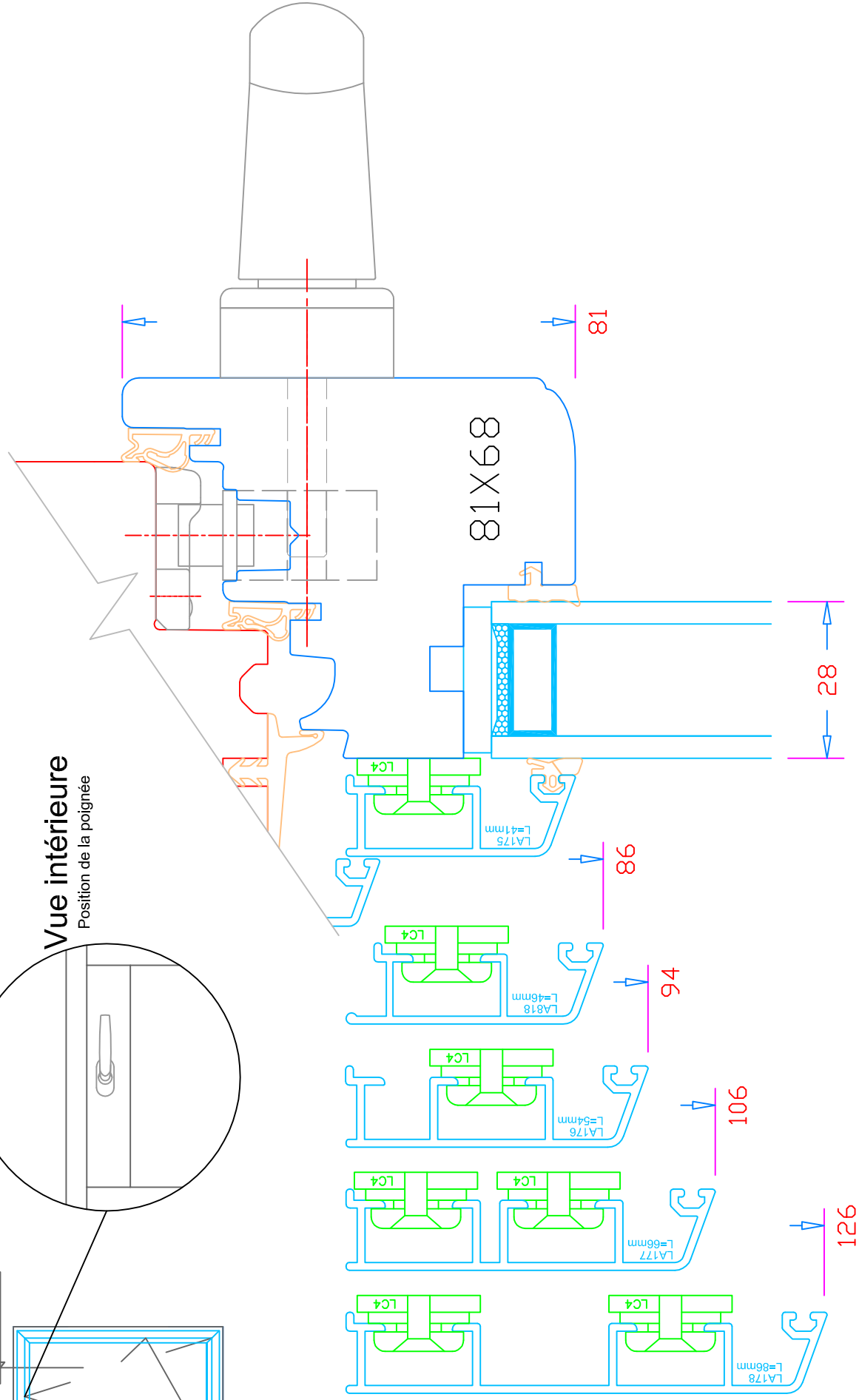

Coupe 08c

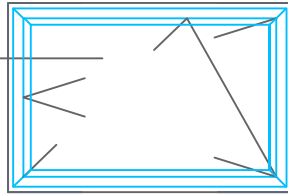

Largeur ouvrant



Attention, lorsque qu'il y a une VMC, la traverse haute doit être élargie à une largeur minimale de 94mm.

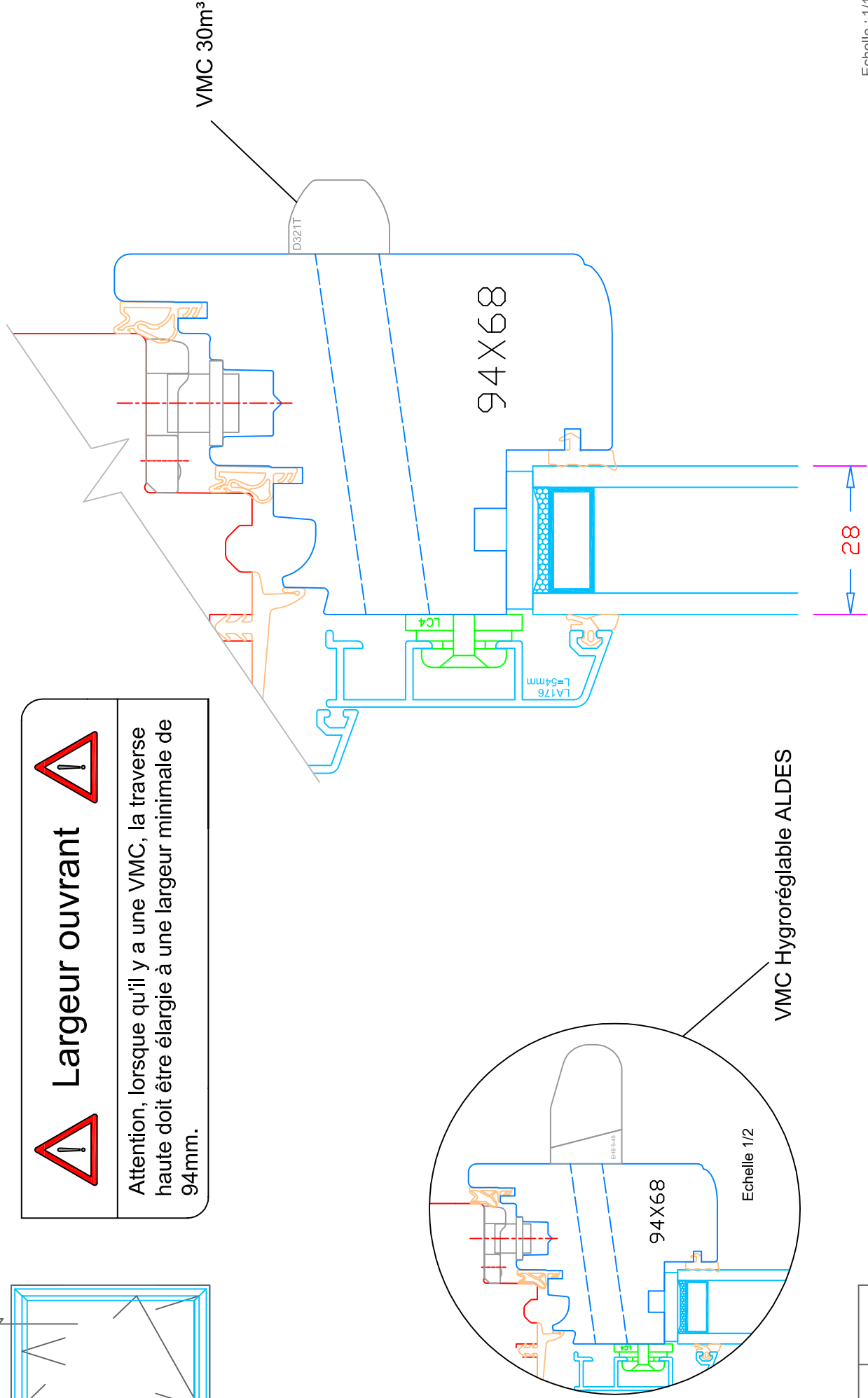

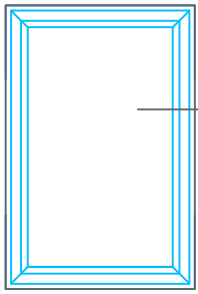

Coupe 09
 Vue Intérieure

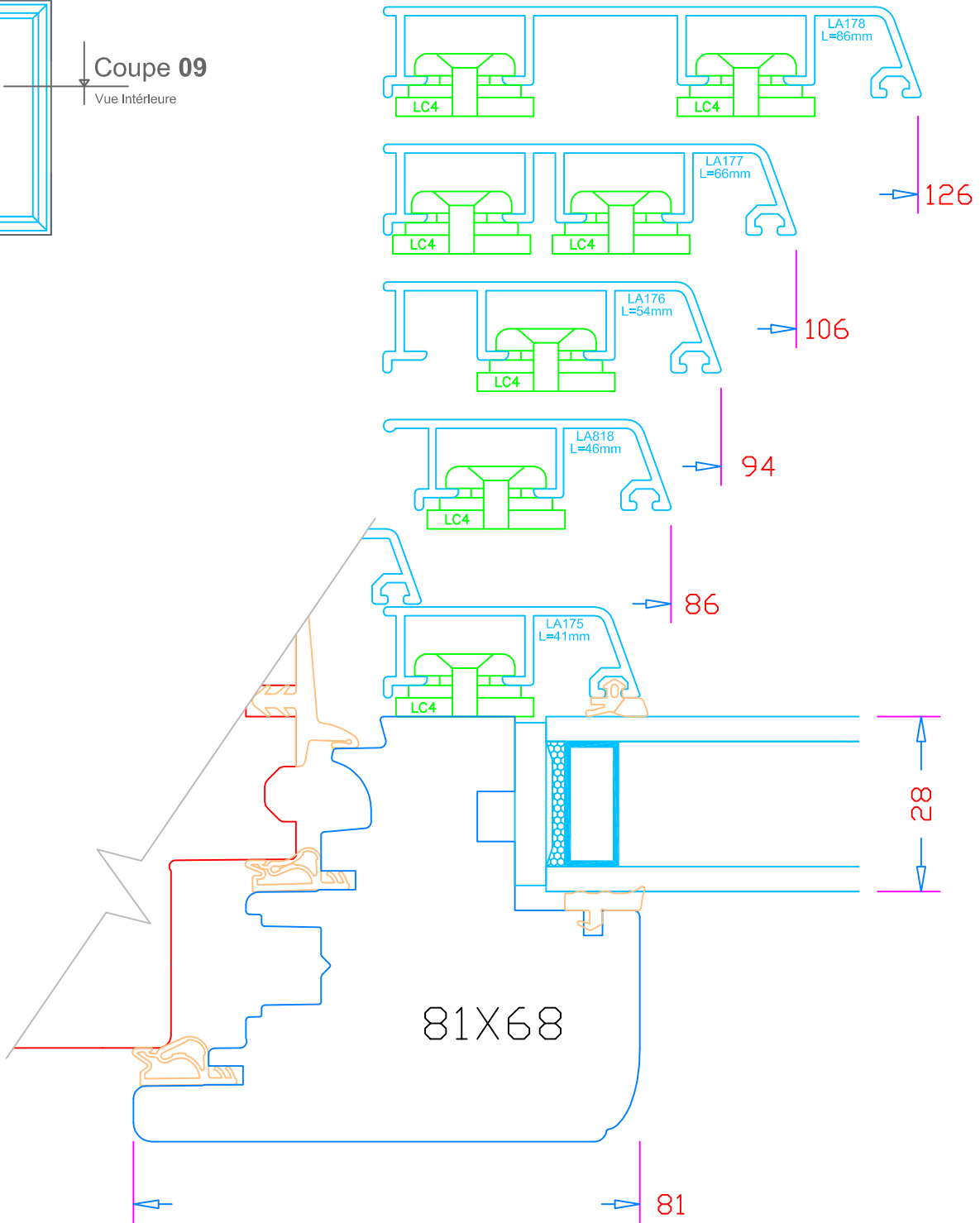

Coupe 10
 Vue intérieure

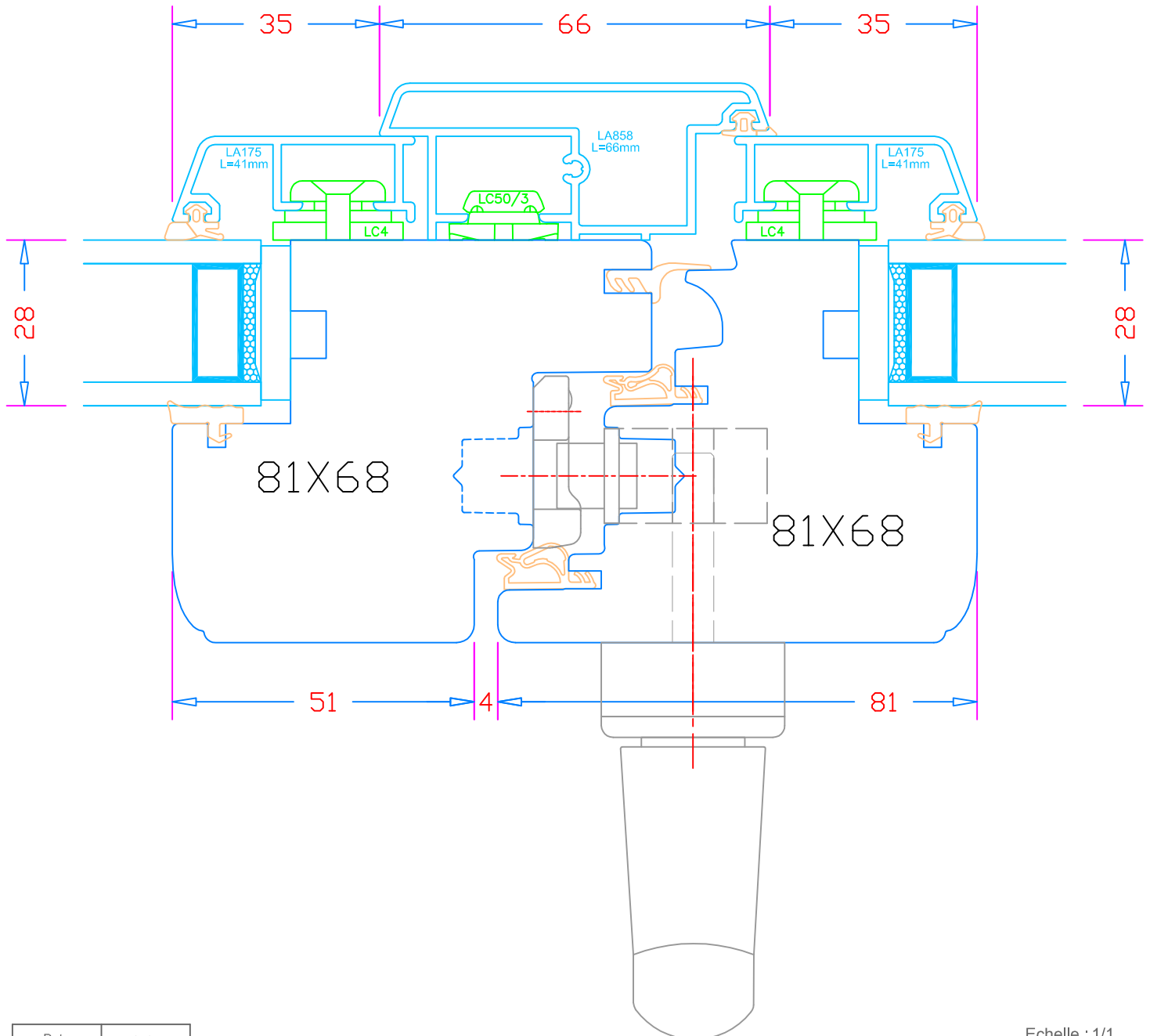
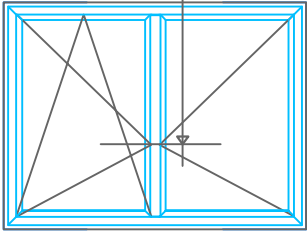

Coupe 11
 Vue intérieure

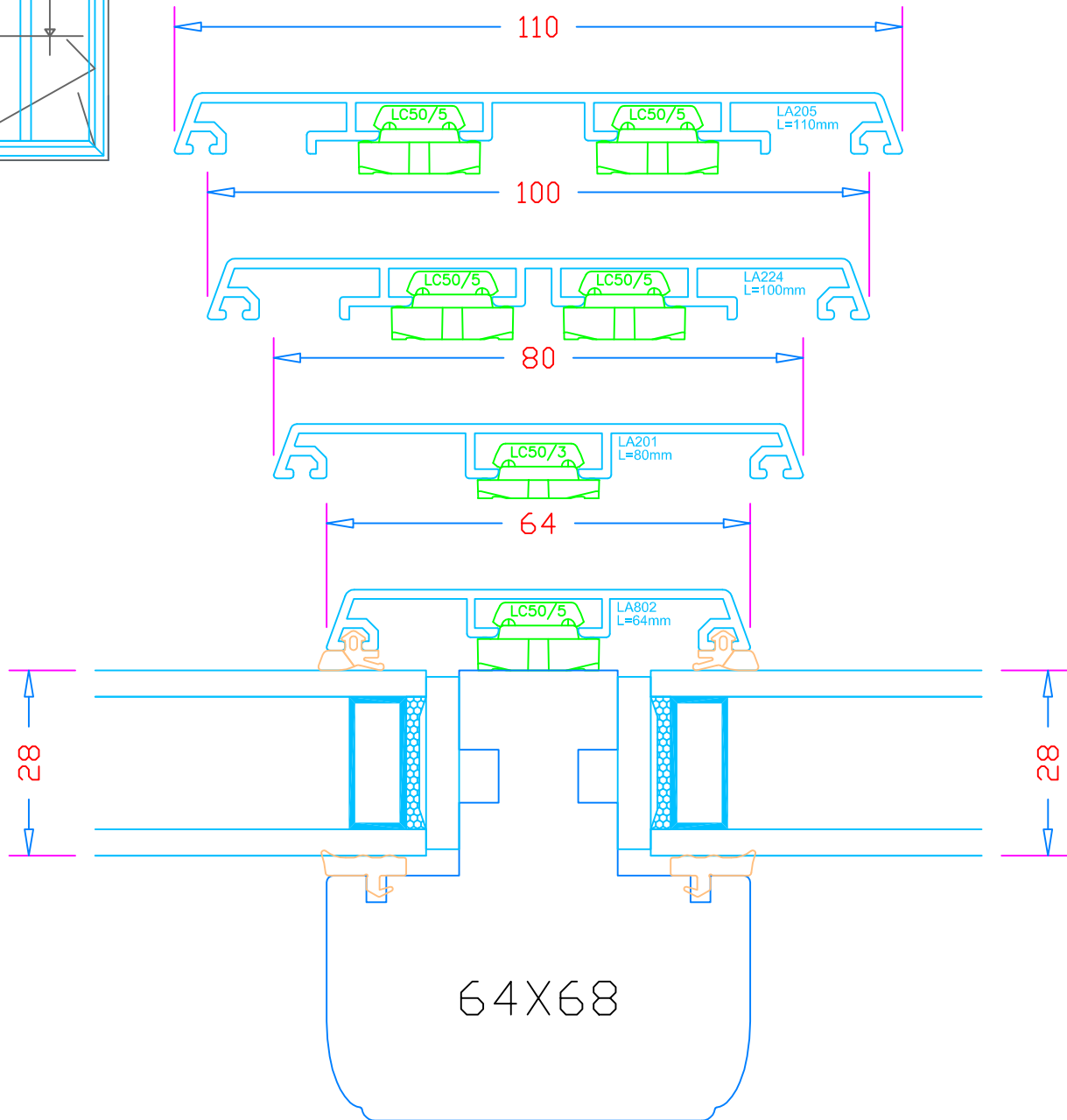
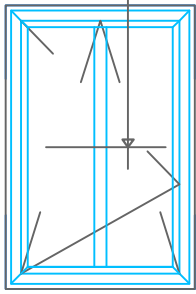

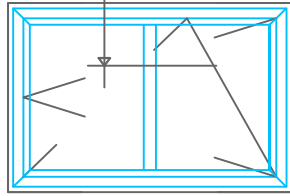

Coupe 12

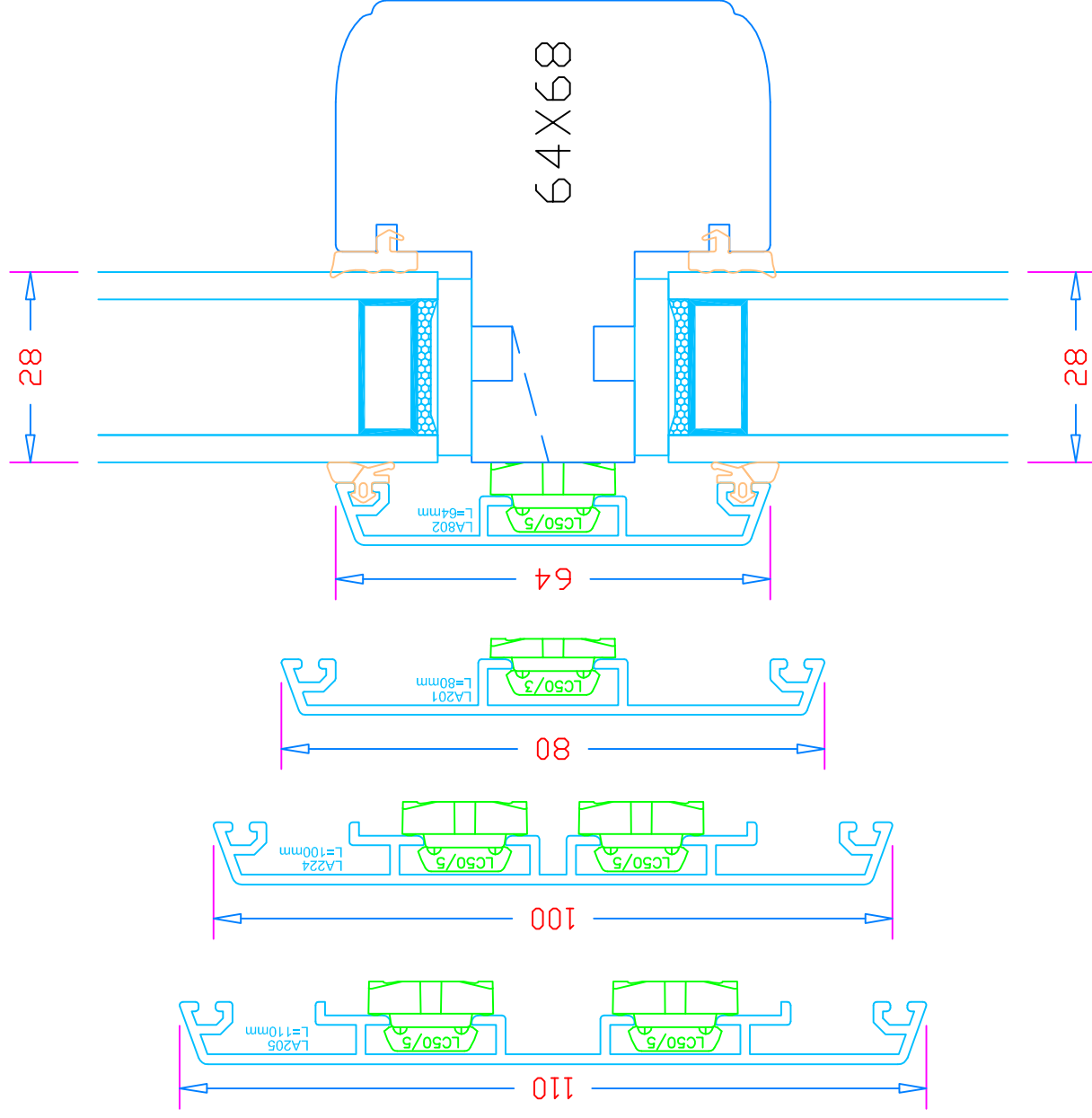

Coupe 13
 Vue intérieure

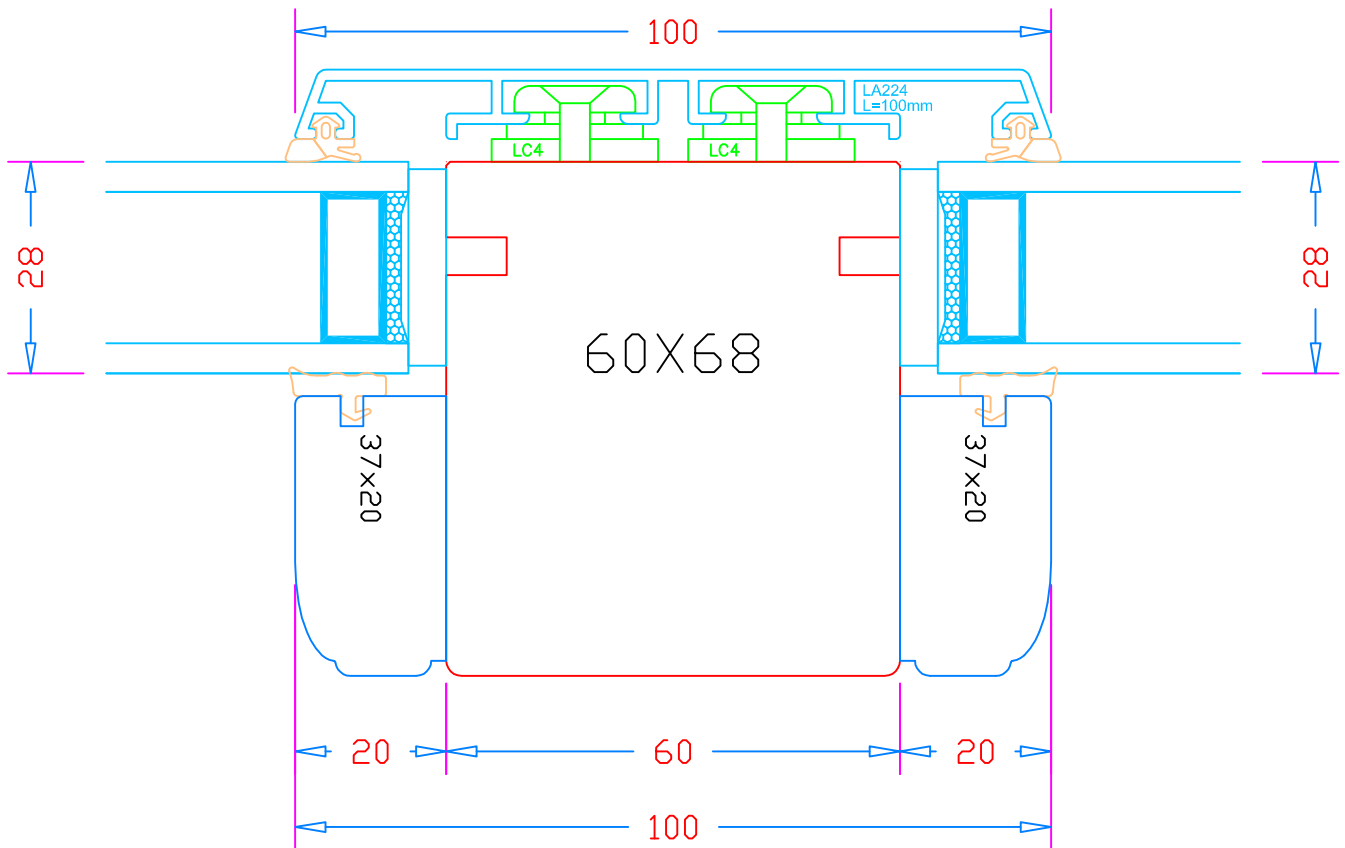
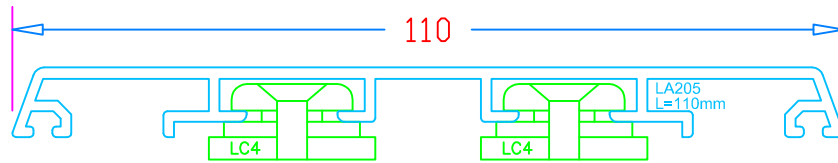
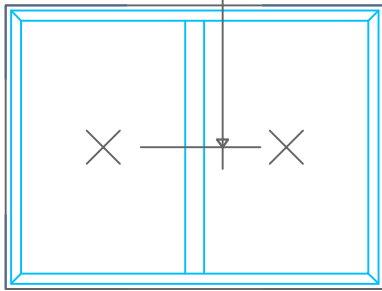

Coupe 14a
Vue intérieure

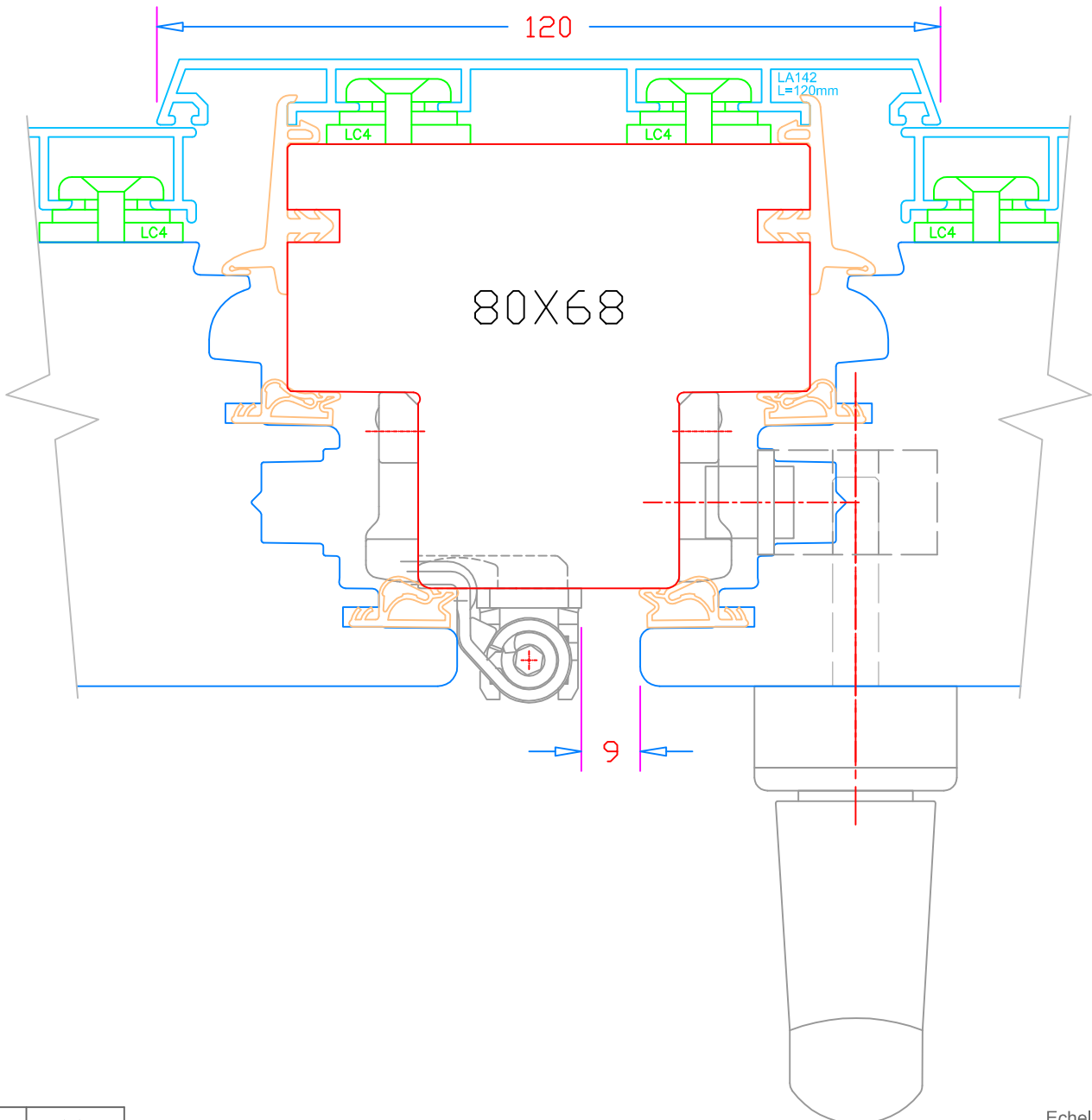
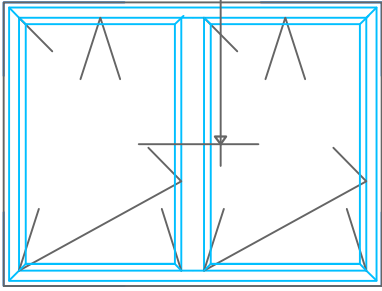

Coupe 14b
Vue intérieure

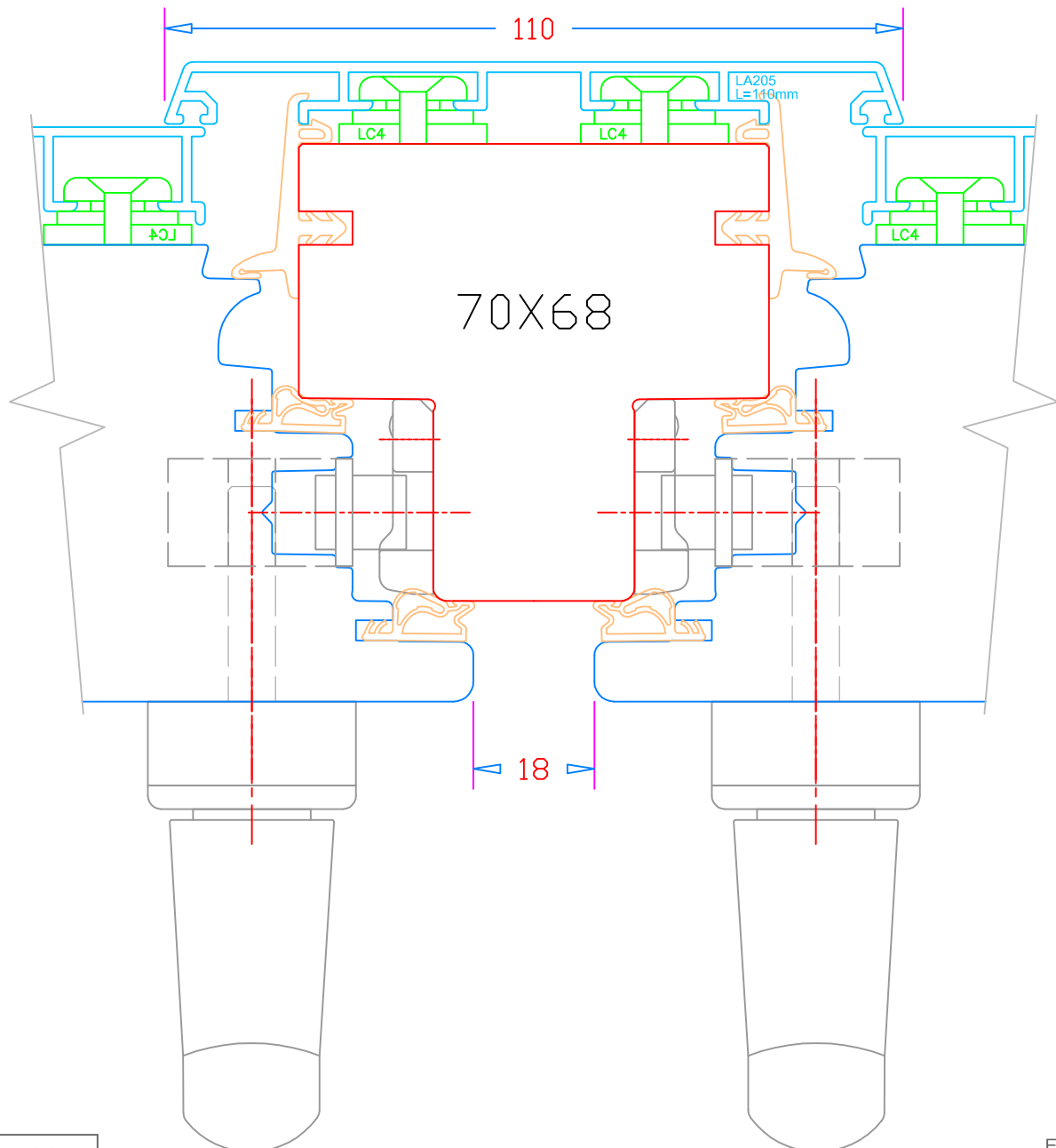
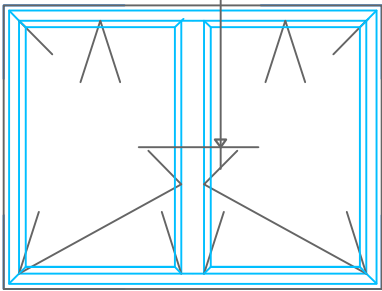

Coupe 14d
 Vue intérieure

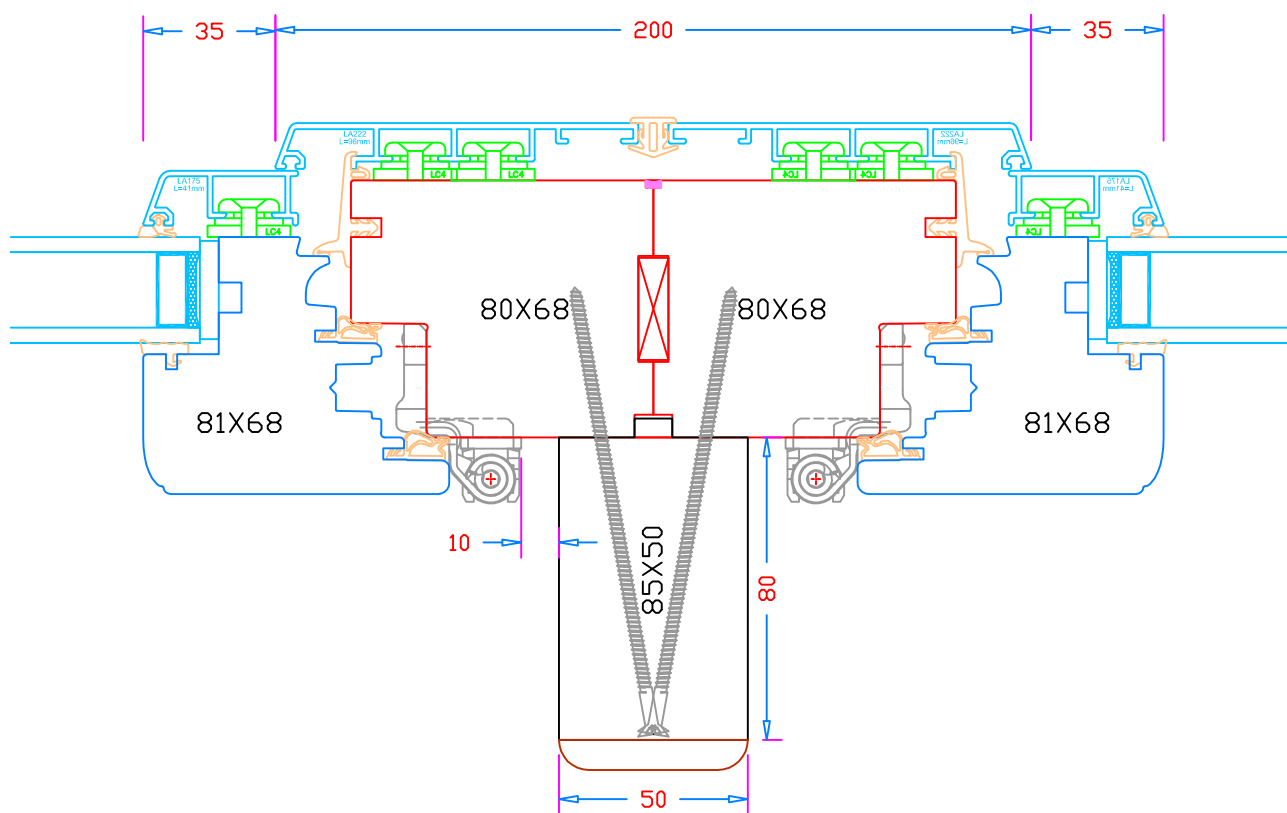
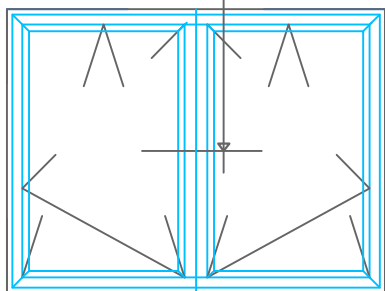

Coupe 14c
Vue intérieure

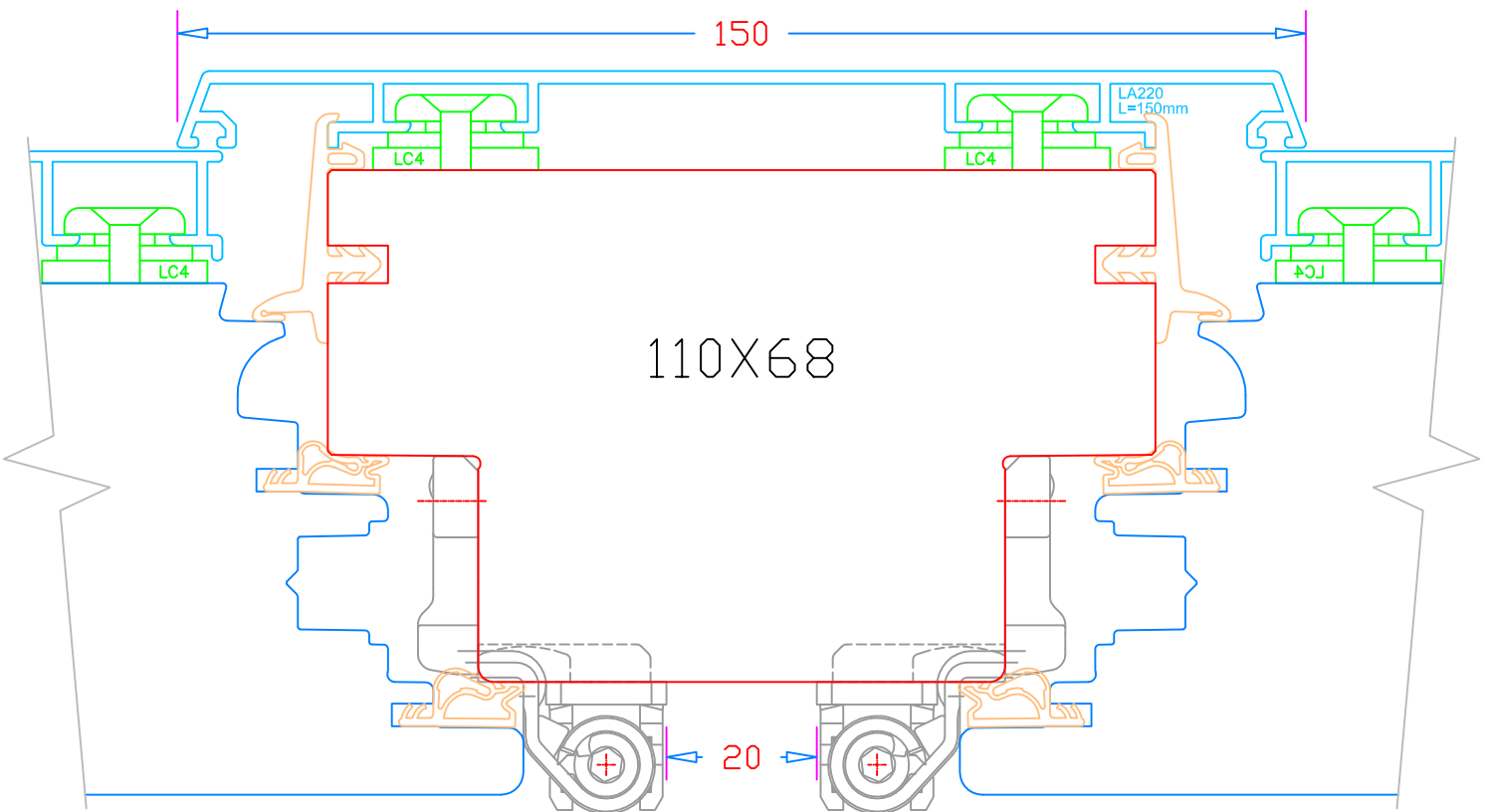
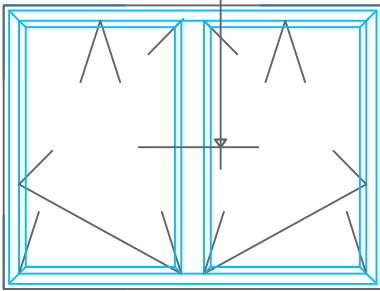

Coupe 15a
 Vue intérieure

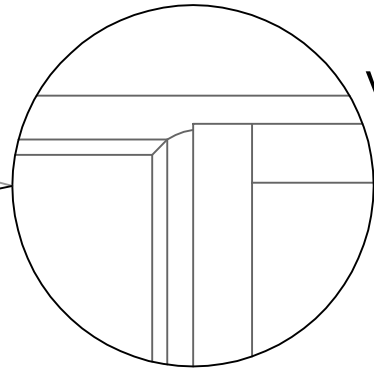
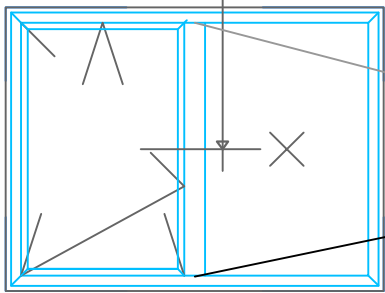

Vue intérieure
 Assemblage du meneau

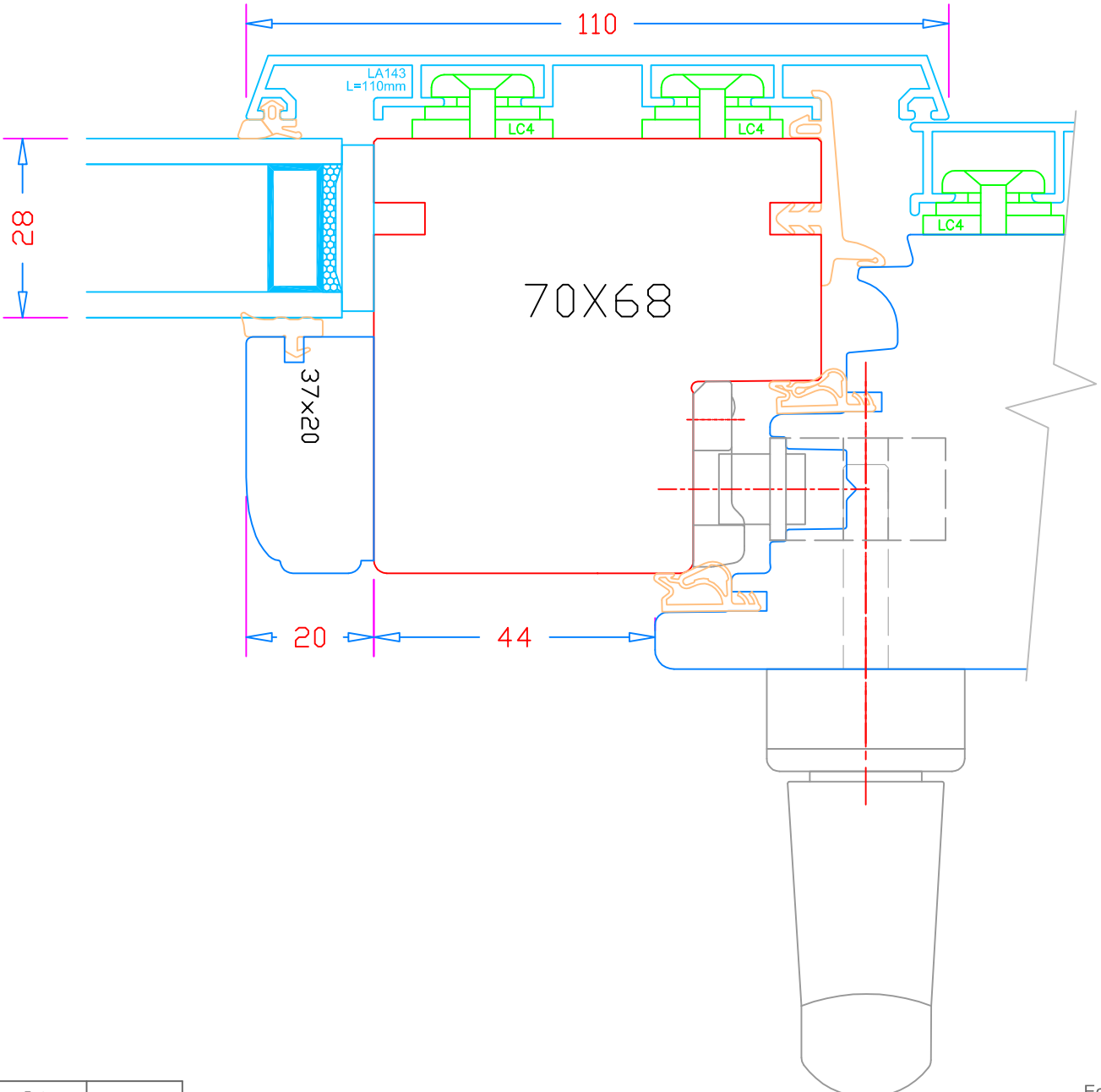

Coupe 15b
 Vue intérieure

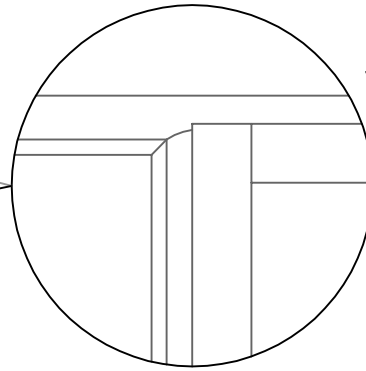
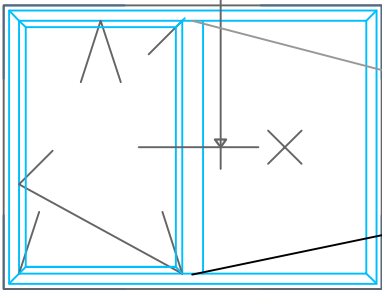

Vue intérieure
 Assemblage du meneau

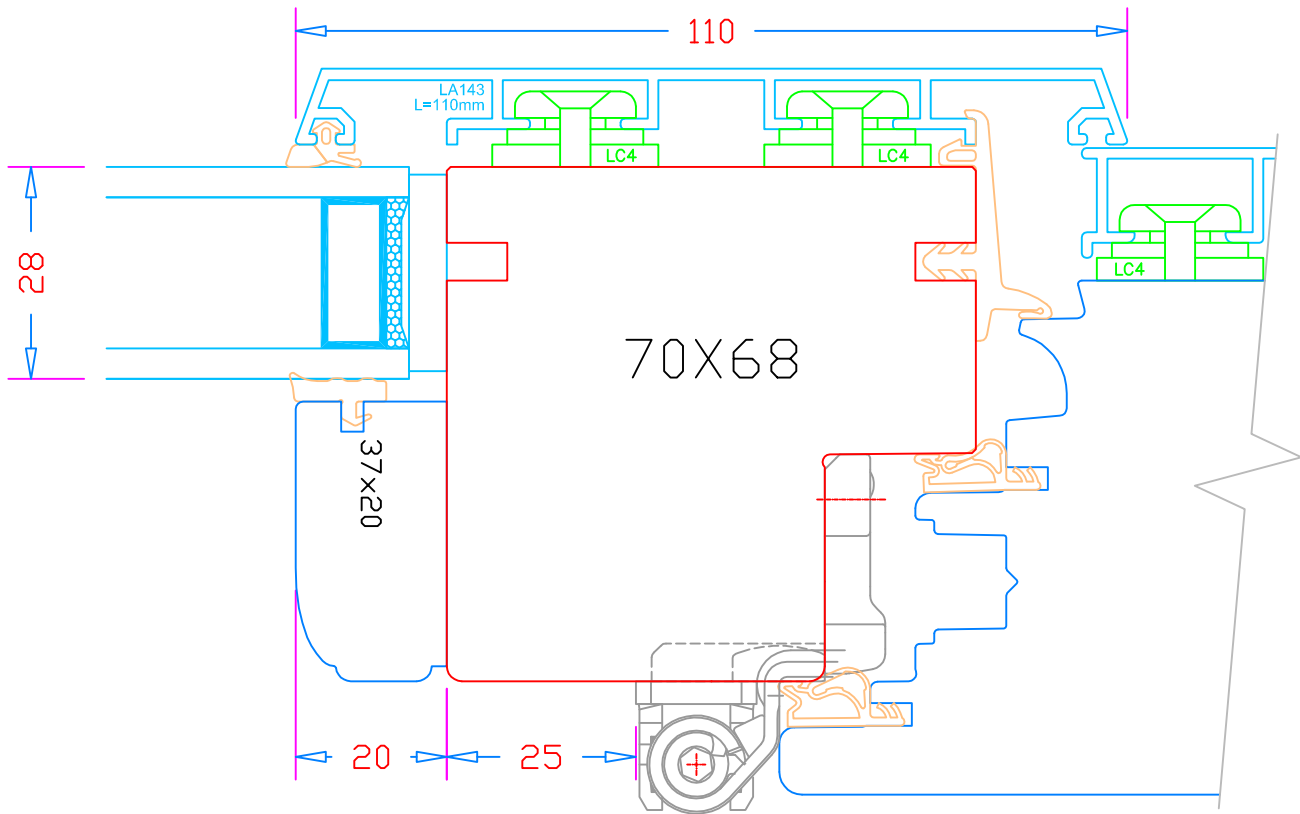

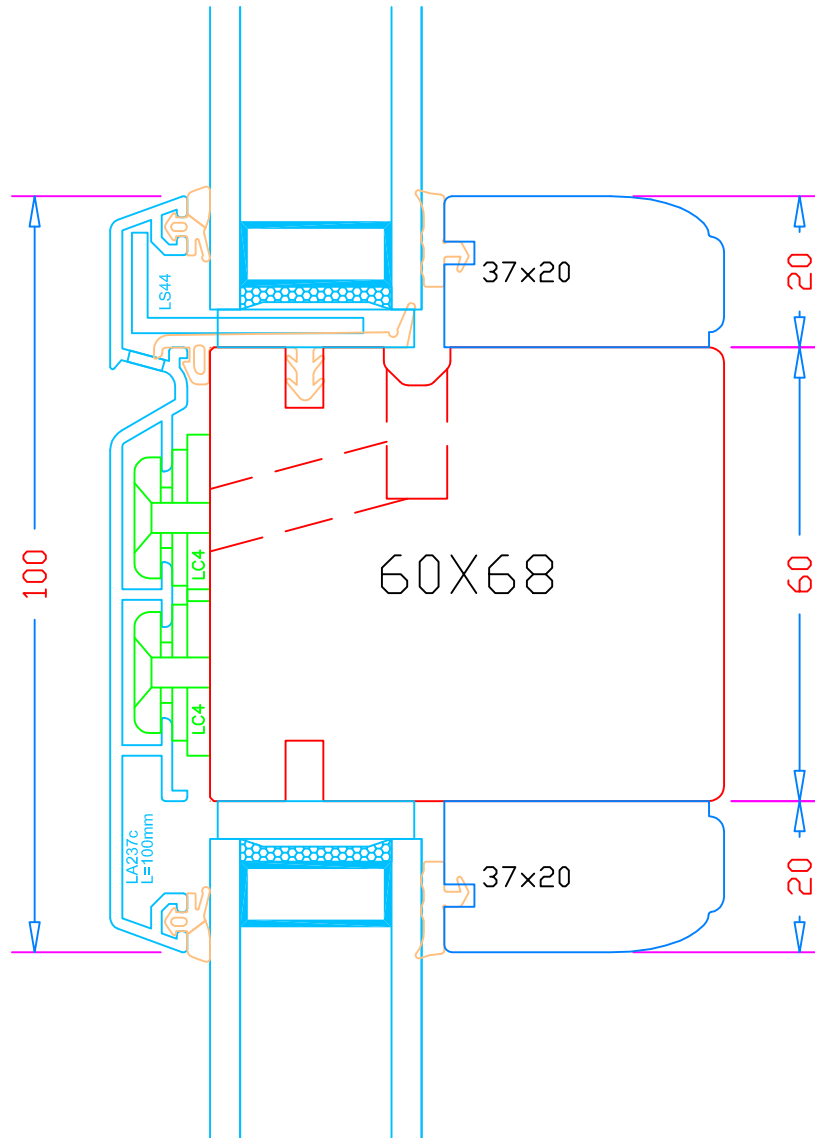
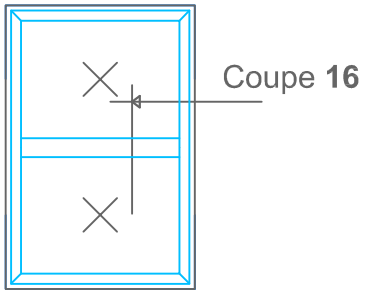

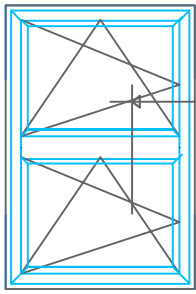

Coupe 17a

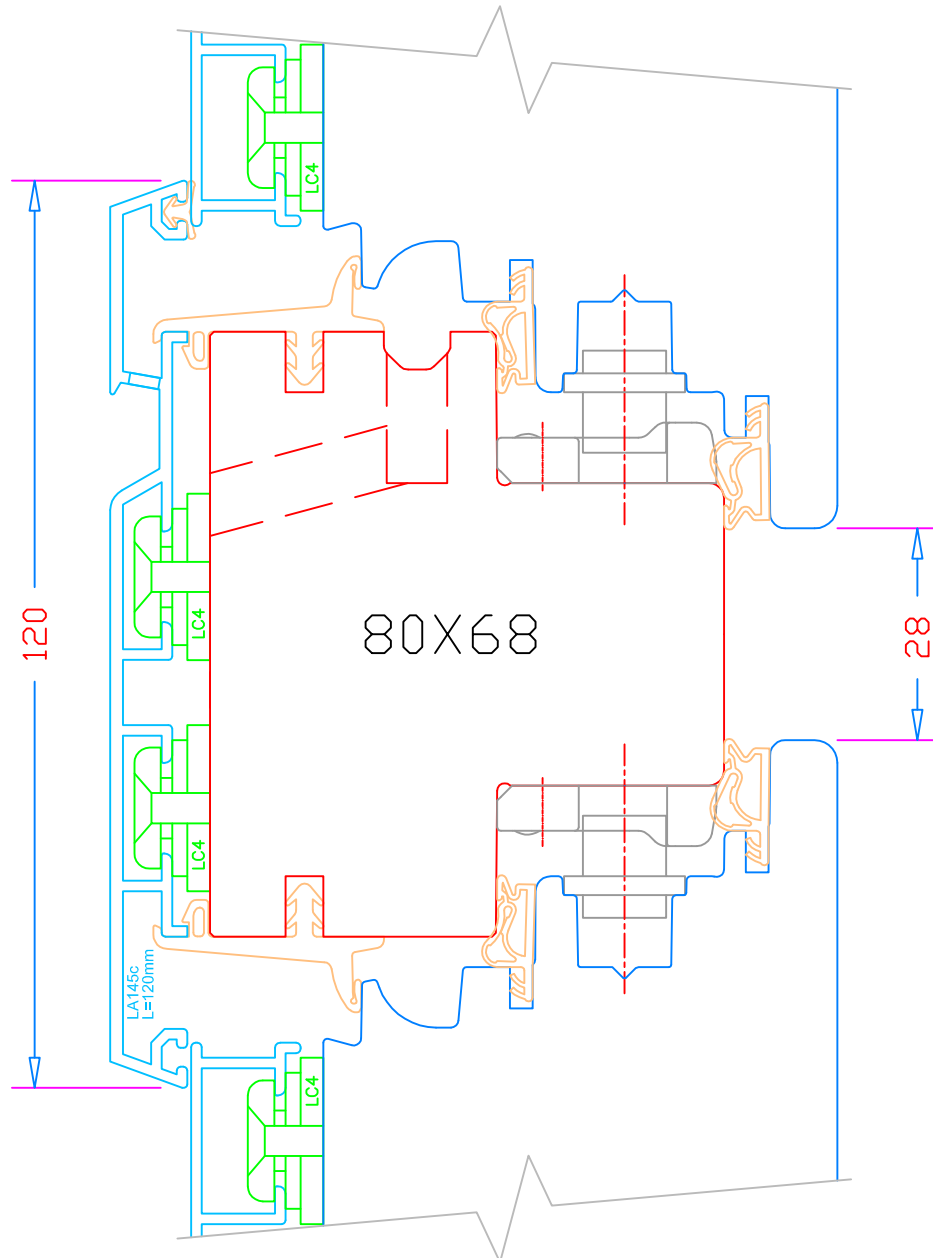

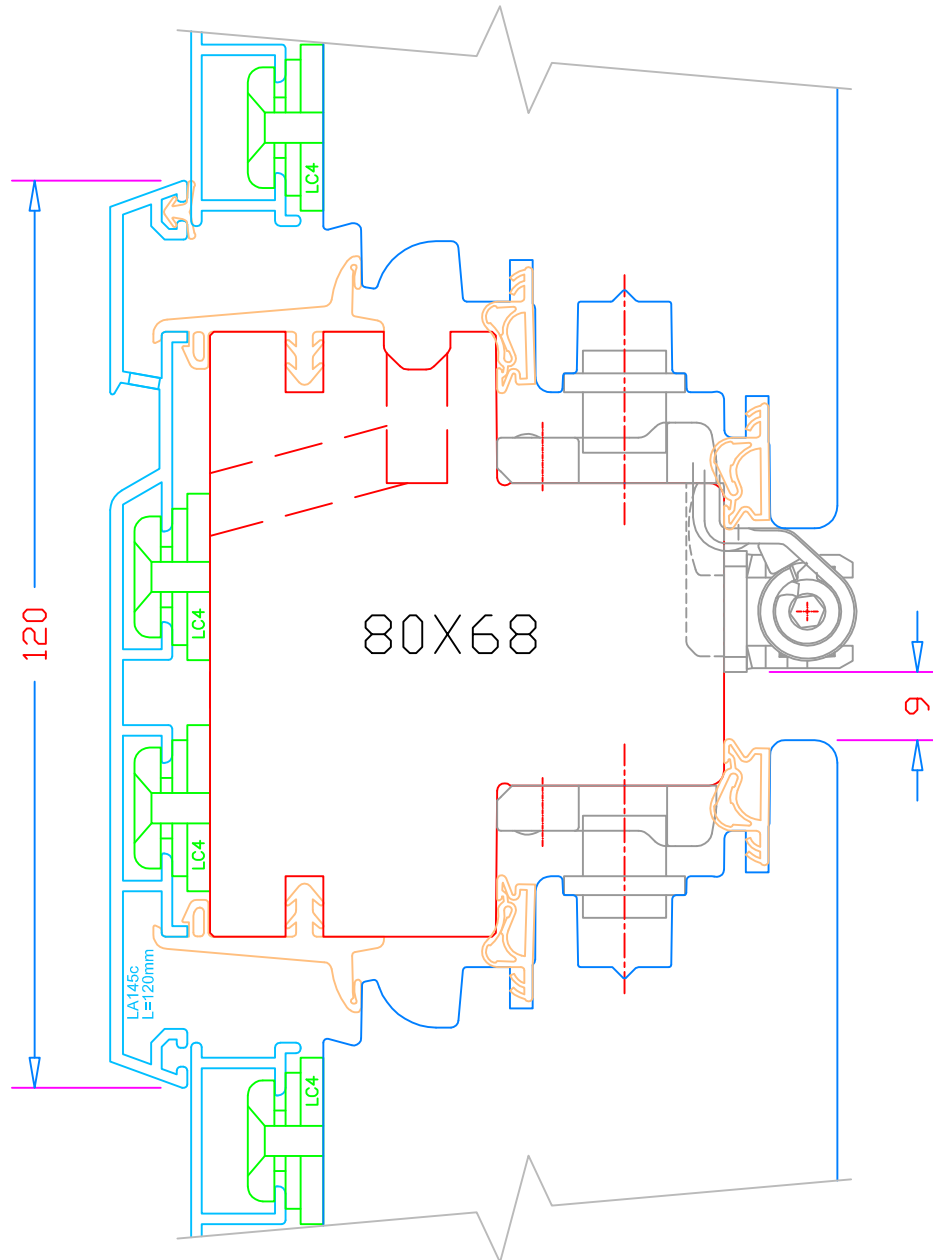
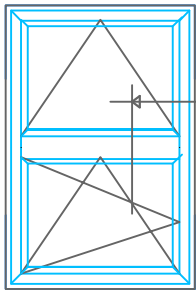

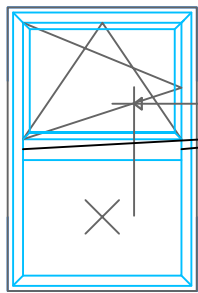

Coupe 18a

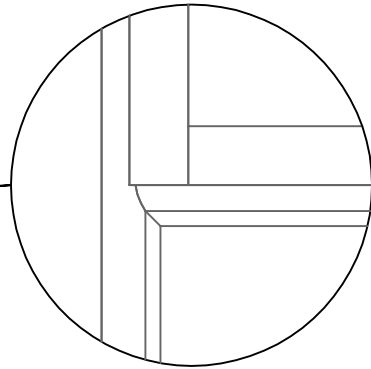

Vue intérieure

Assemblage de la traverse intermédiaire

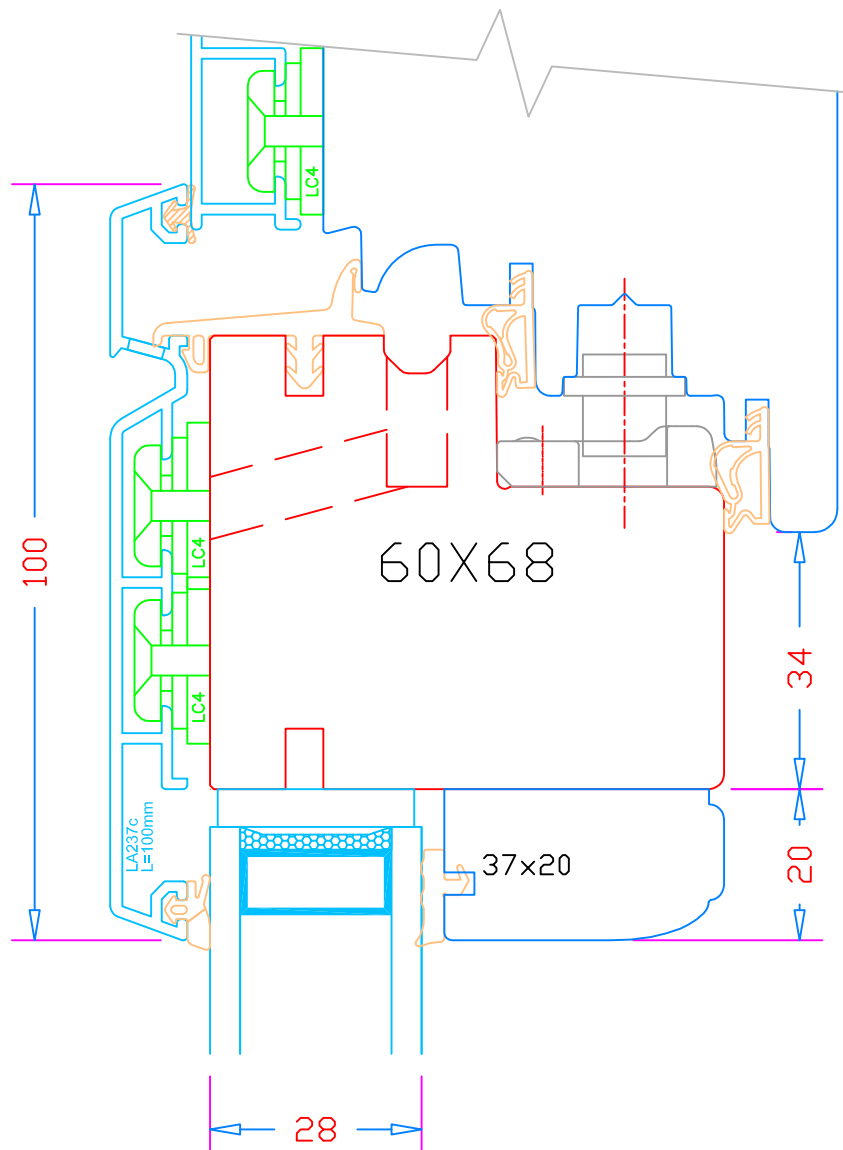

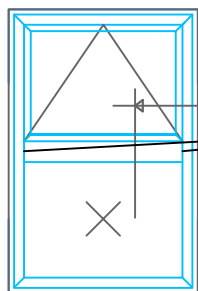

Coupe 18b

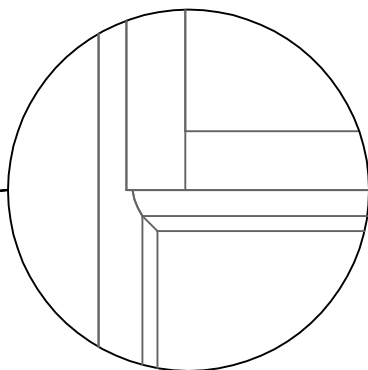

Vue intérieure

Assemblage de la traverse intermédiaire

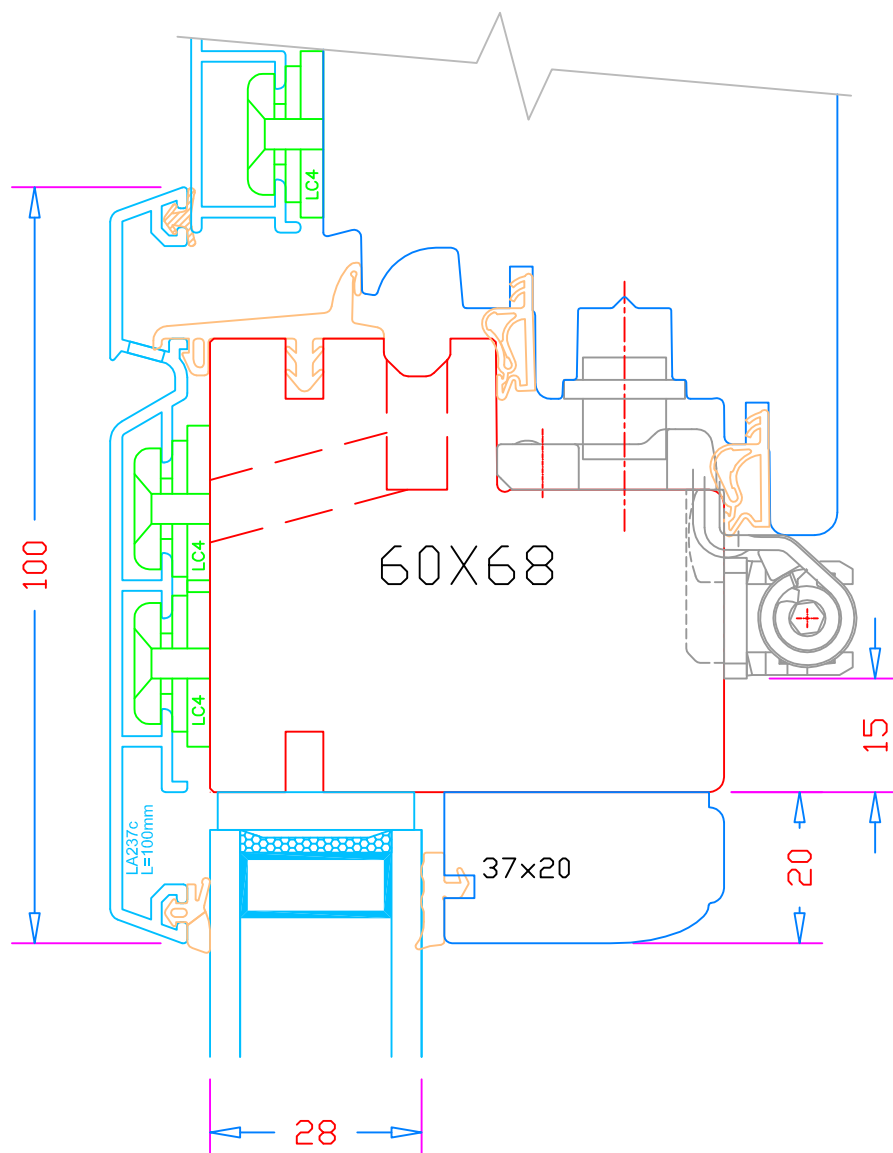

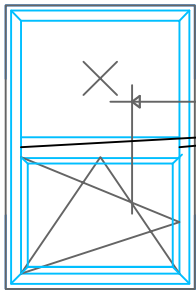

Coupe 19

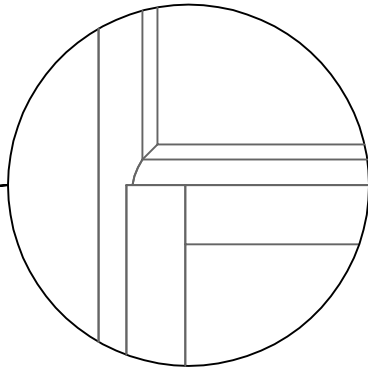

Vue intérieure

Assemblage de la traverse intermédiaire

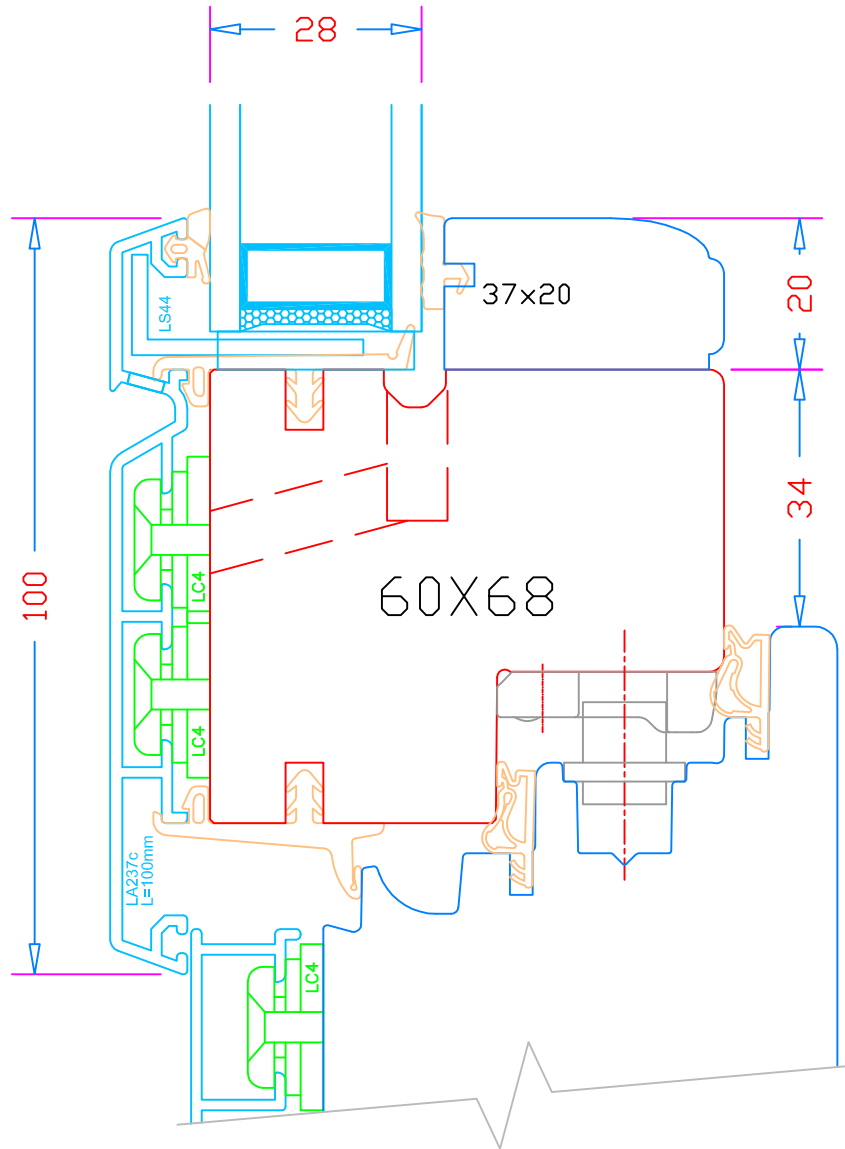

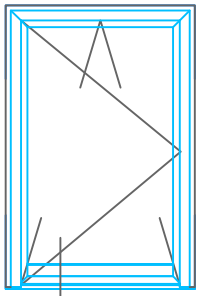

Coupe 20a

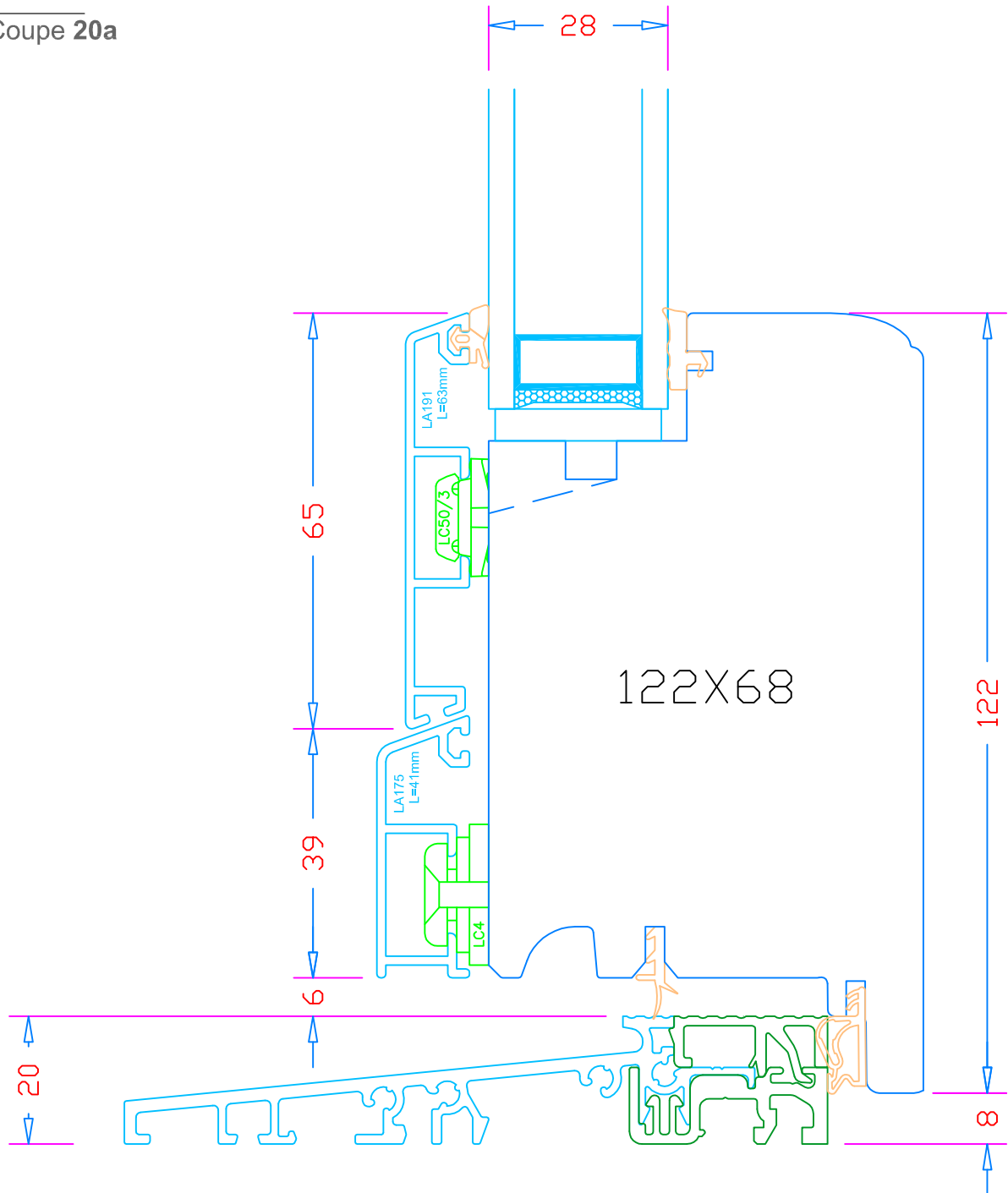

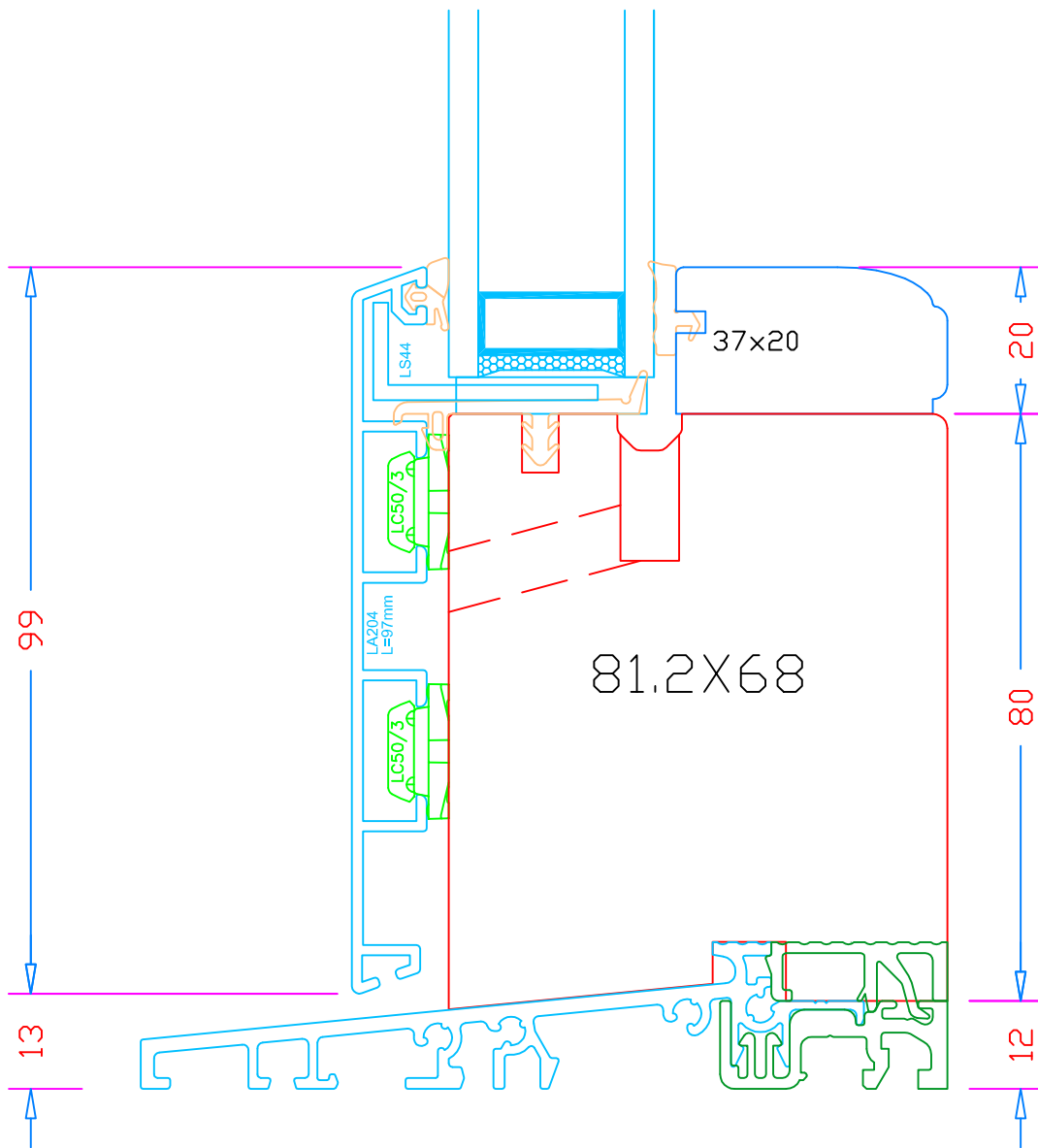
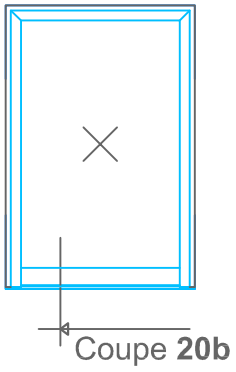

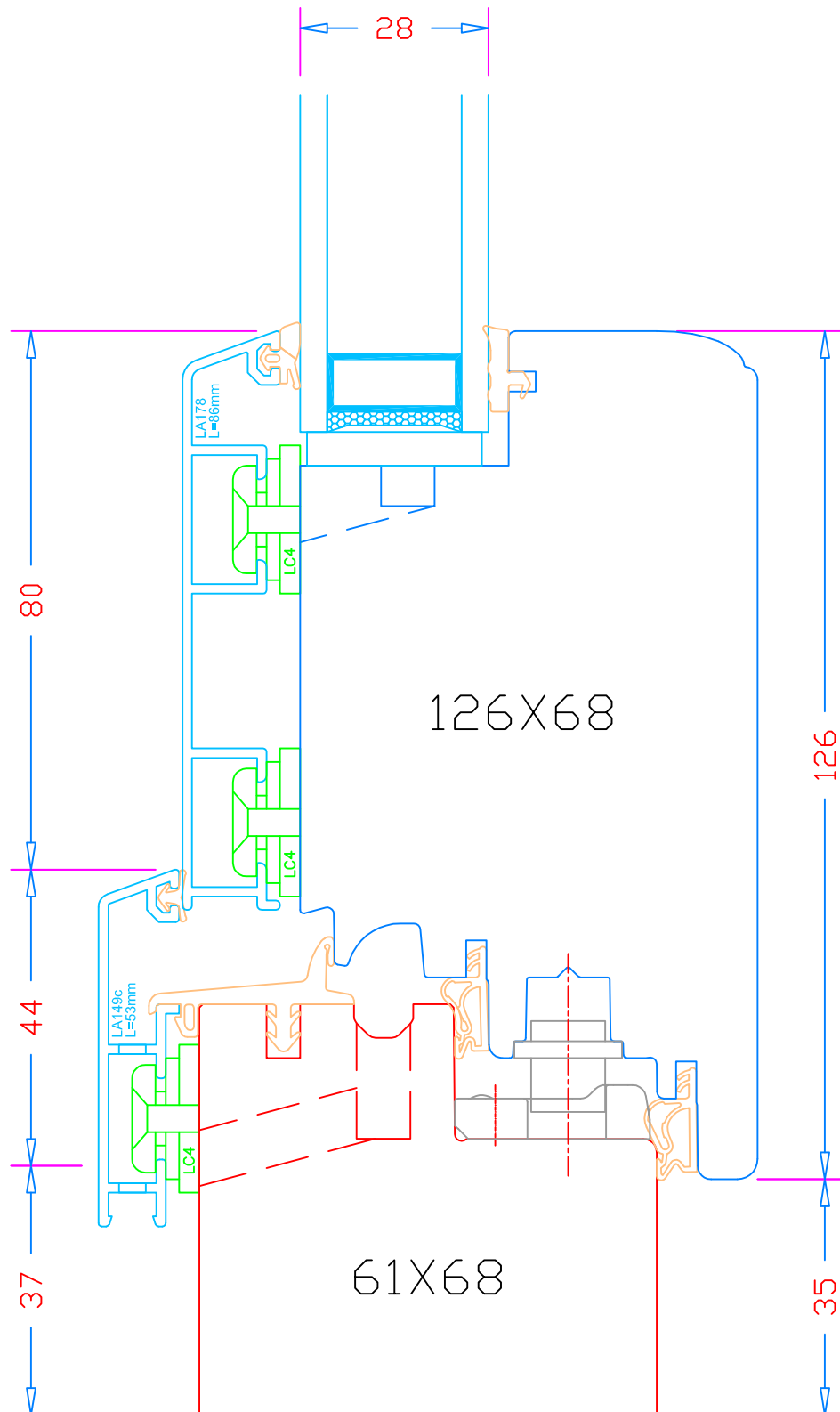
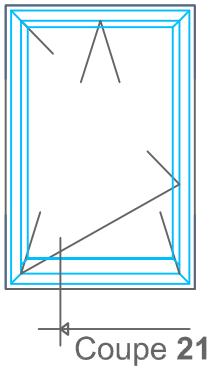

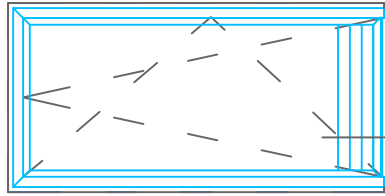

Coupe 22a



UNIQUEMENT



Porte balcon 1 vantail.

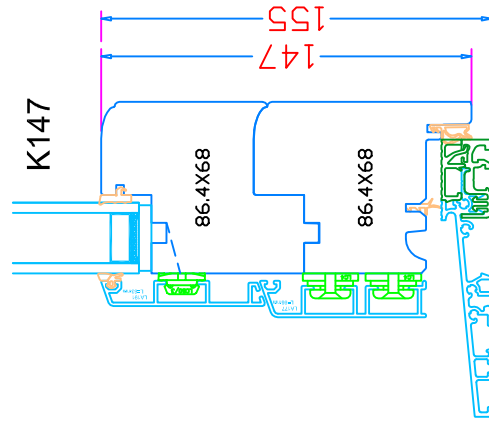
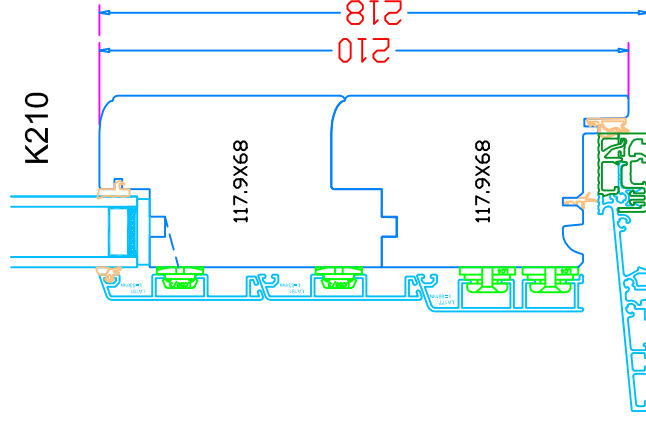
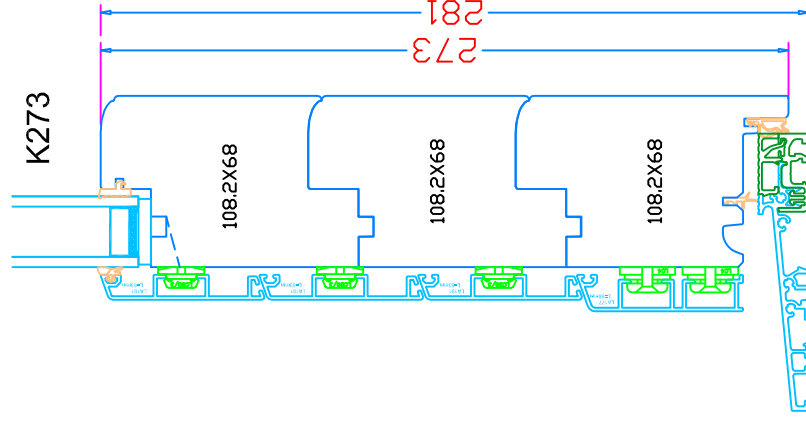
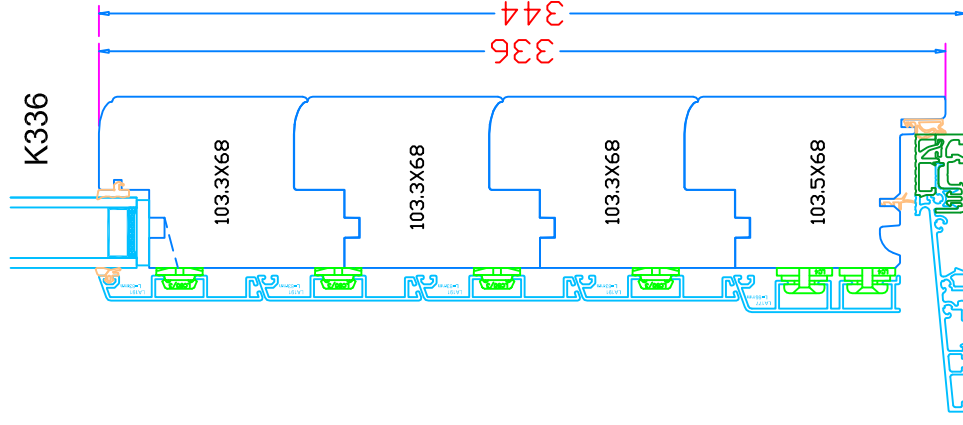

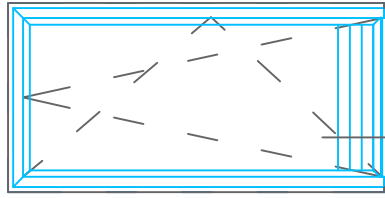

Coupe 22b



UNIQUEMENT

Porte fenêtre 1 et 2 vantaux
Porte balcon 2 vantaux

K122 : Impossible si meneau
sur traverse basse.
Prendre K185

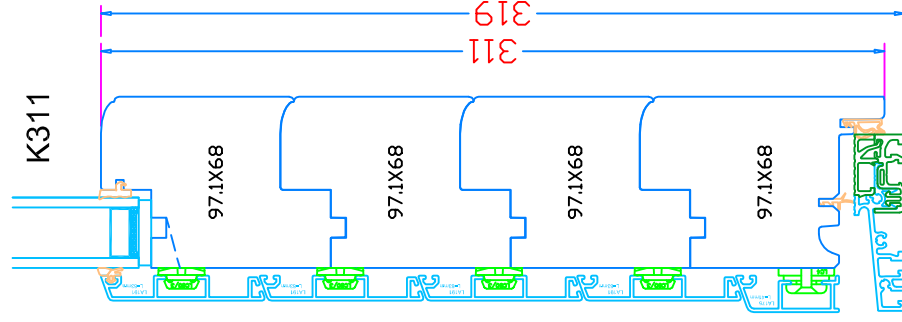
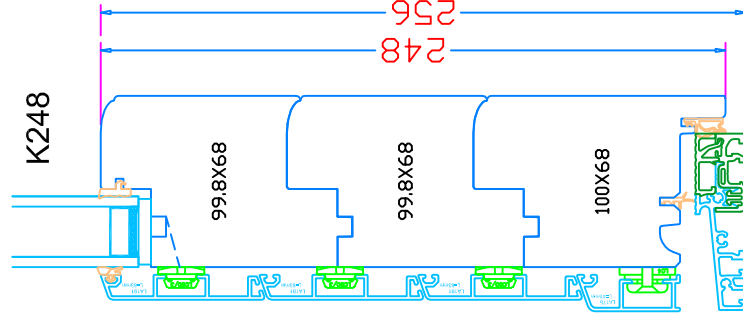
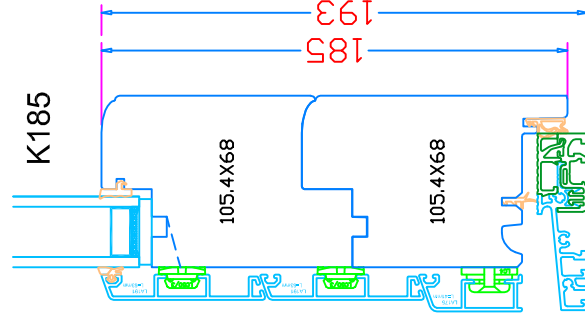
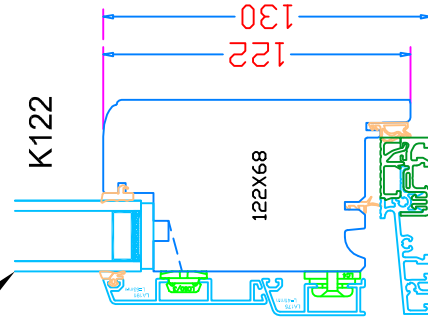

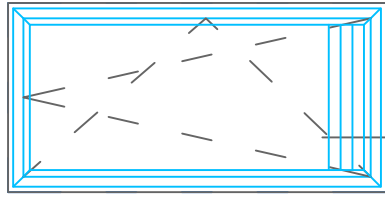

Coupe 23a



UNIQUEMENT

Porte balcon 1 vantail.

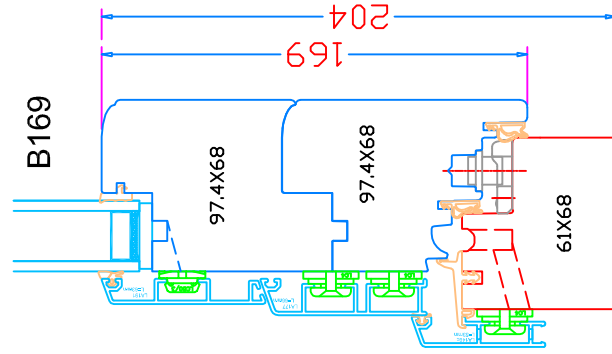
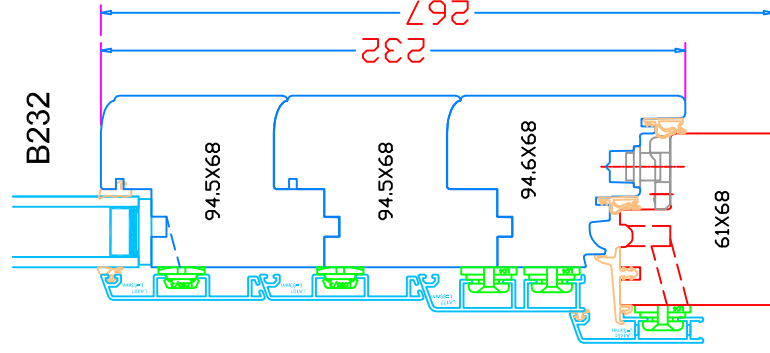
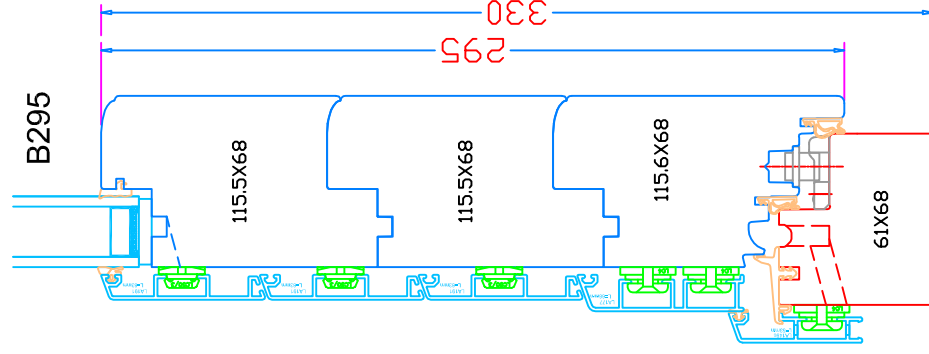
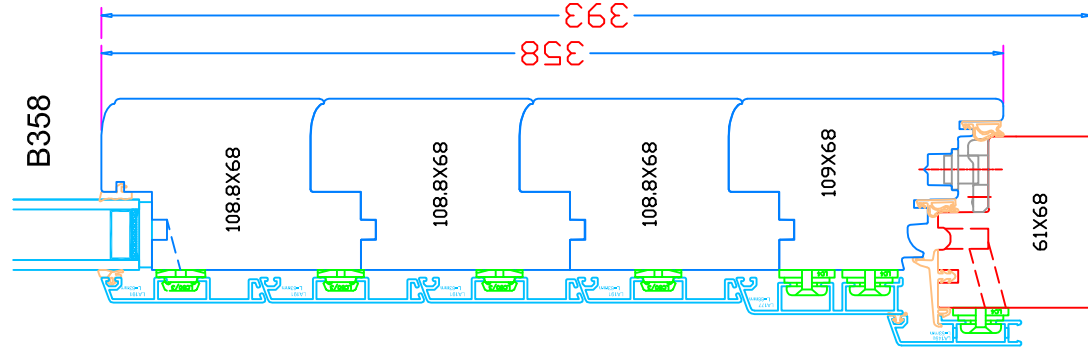

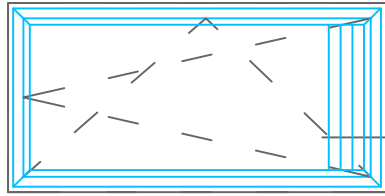

Coupe 23b

UNIQUEMENT

Porte fenêtre 1 et 2 vantaux
Porte balcon 2 vantaux

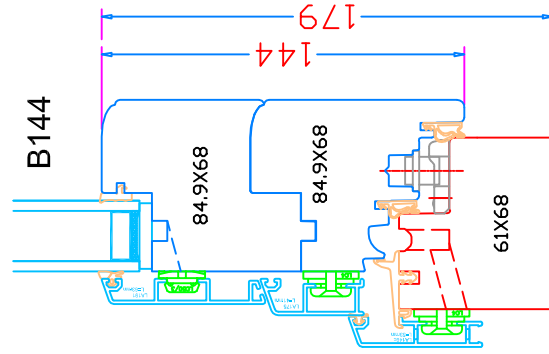
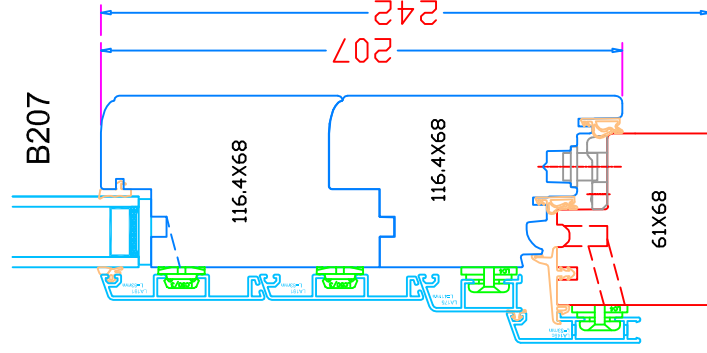
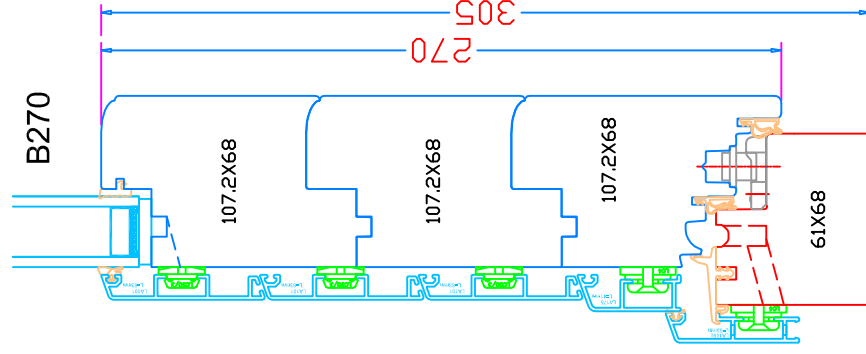
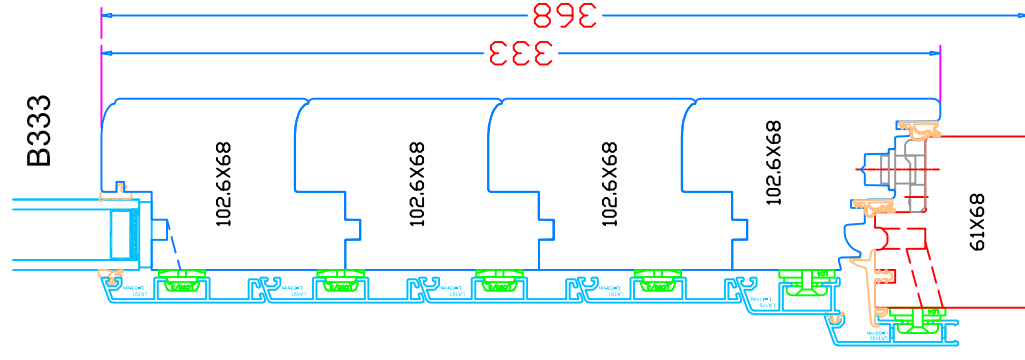

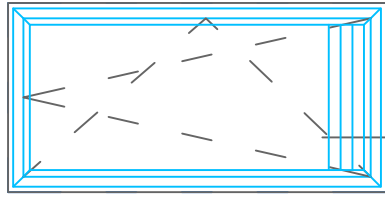

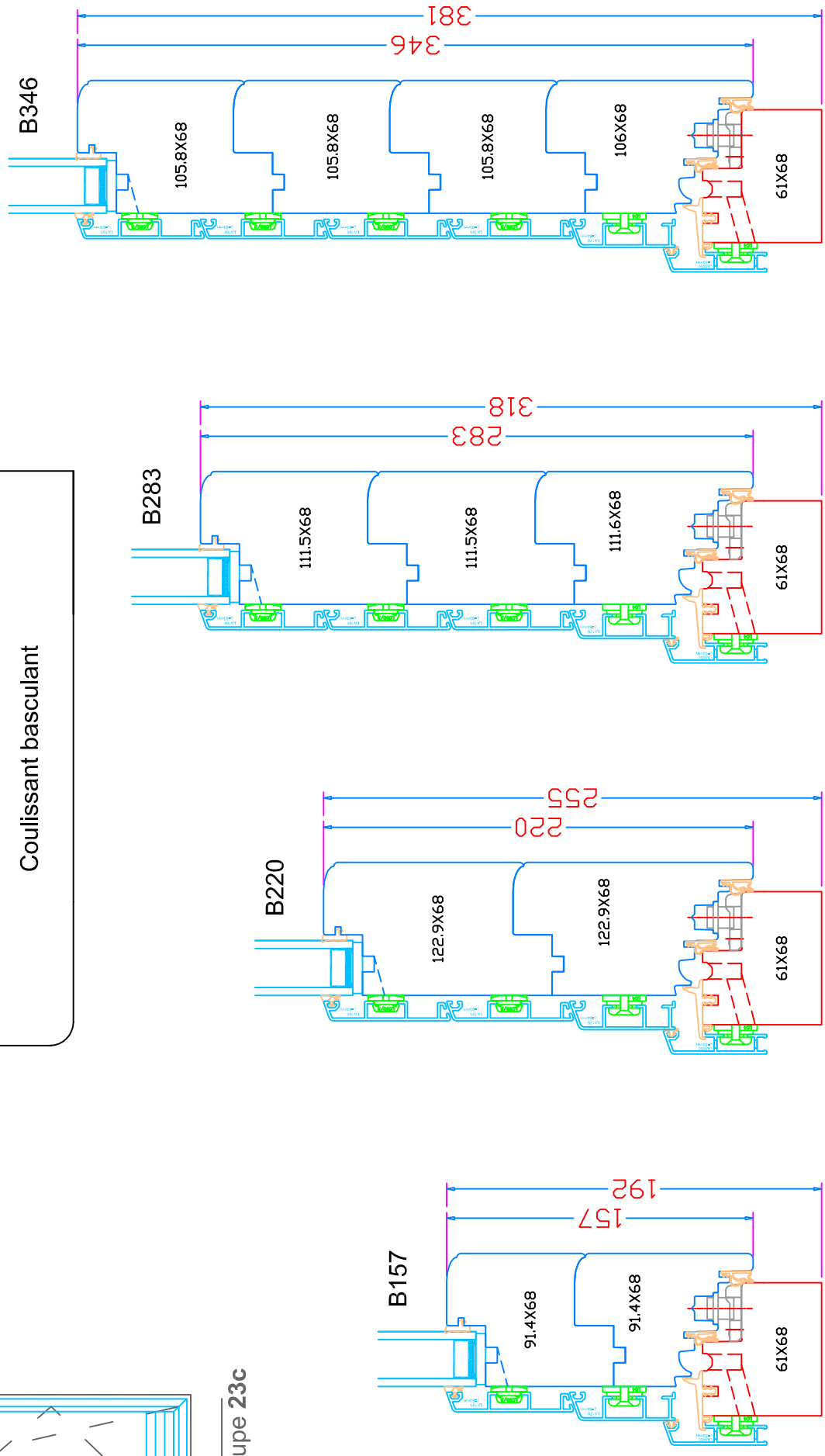

Coupe 23c

	<p>UNIQUEMENT</p>	
<p>Couissant basculant</p>		

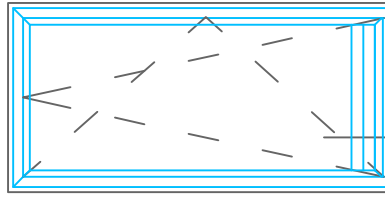

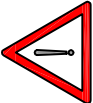

Coupe 24

	<p>UNIQUEMENT</p> 
<p>Porte fenêtre 1 et 2 vantaux. Porte balcon 1 et 2 vantaux.</p>	

S129 : Impossible si meneau sur traverse basse.
Prendre S192

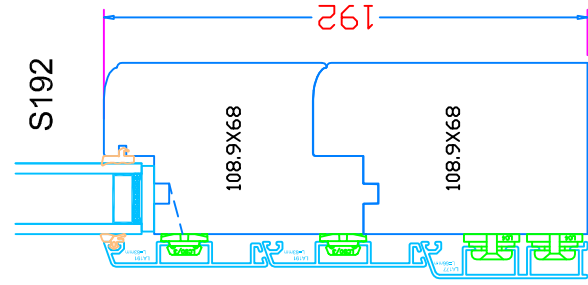
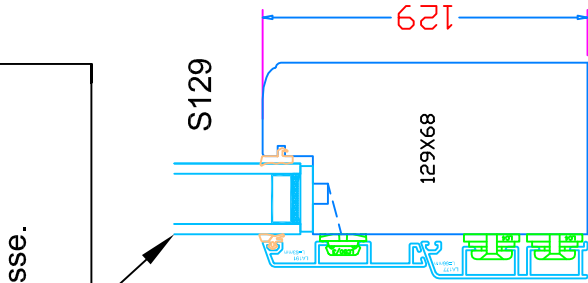

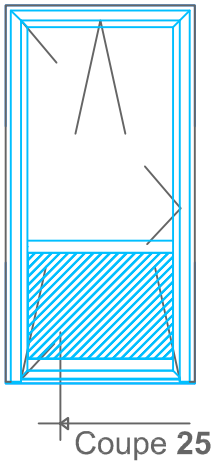

OPTION
 LISSE INTERIEUR

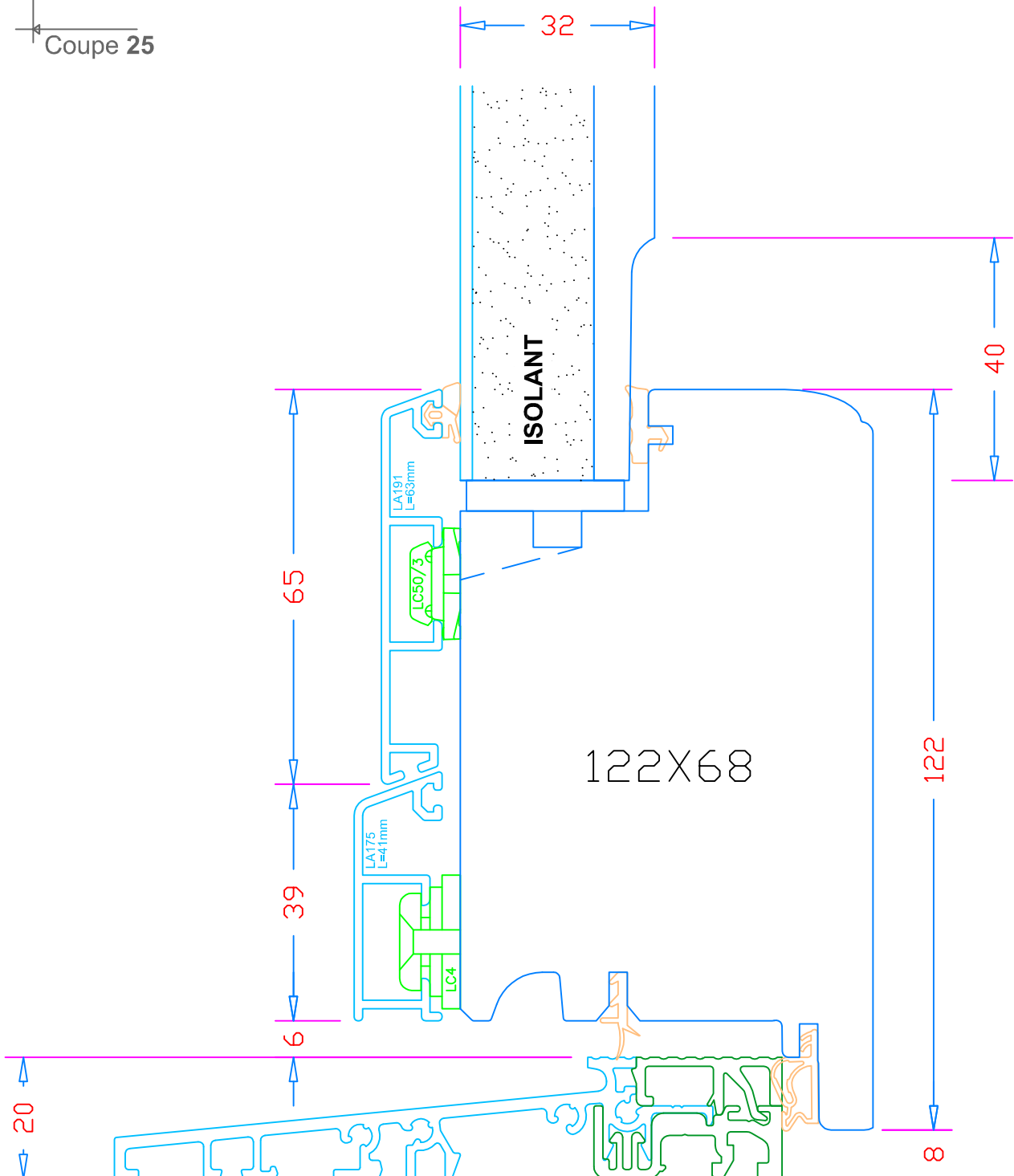
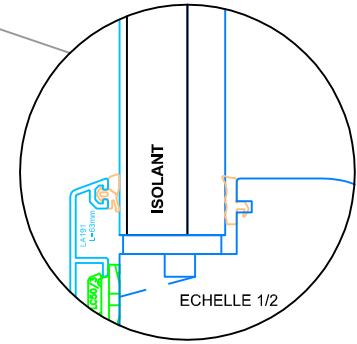

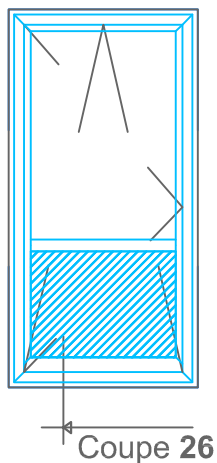

OPTION
 LISSE INTERIEUR

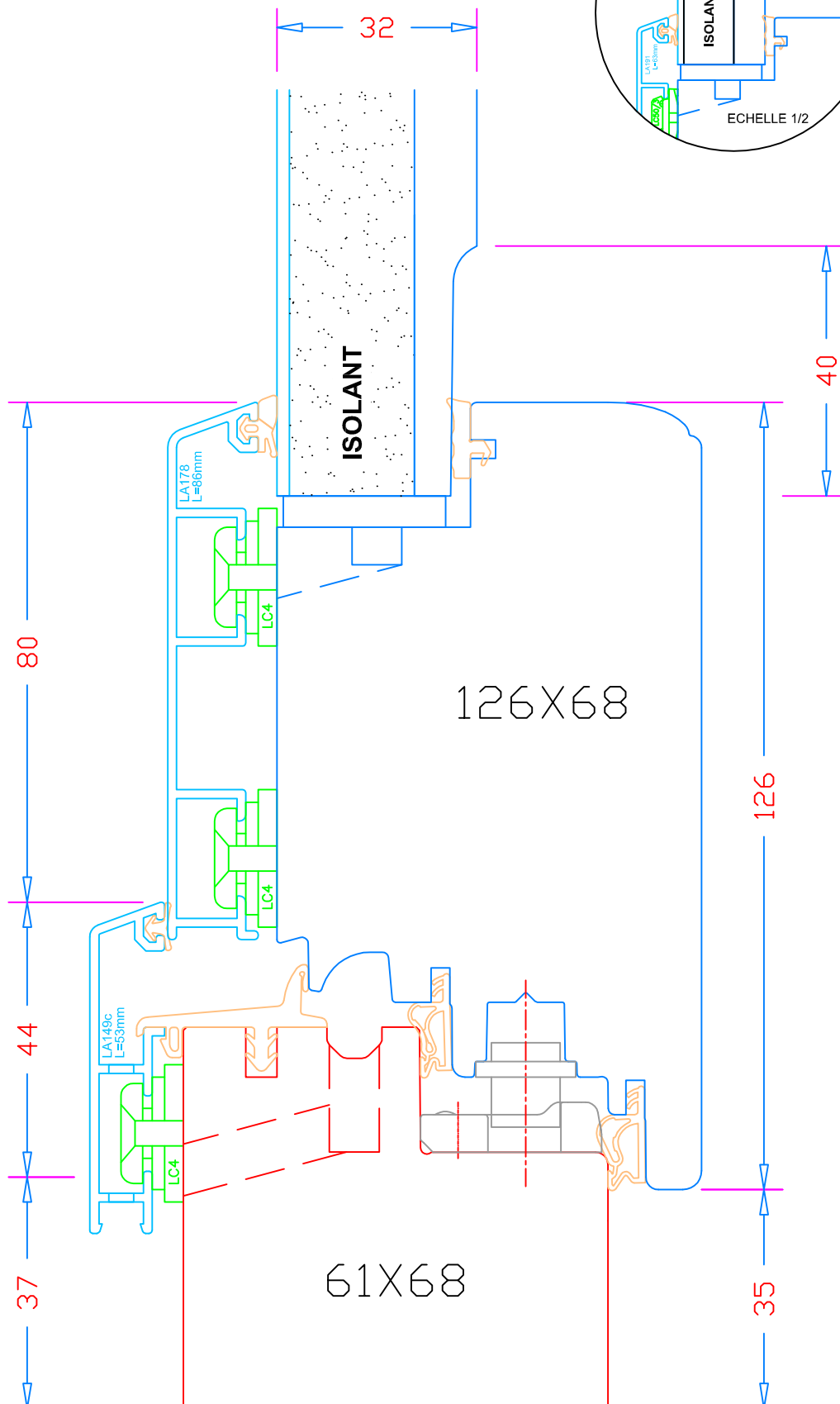
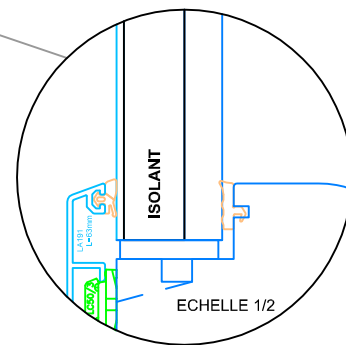

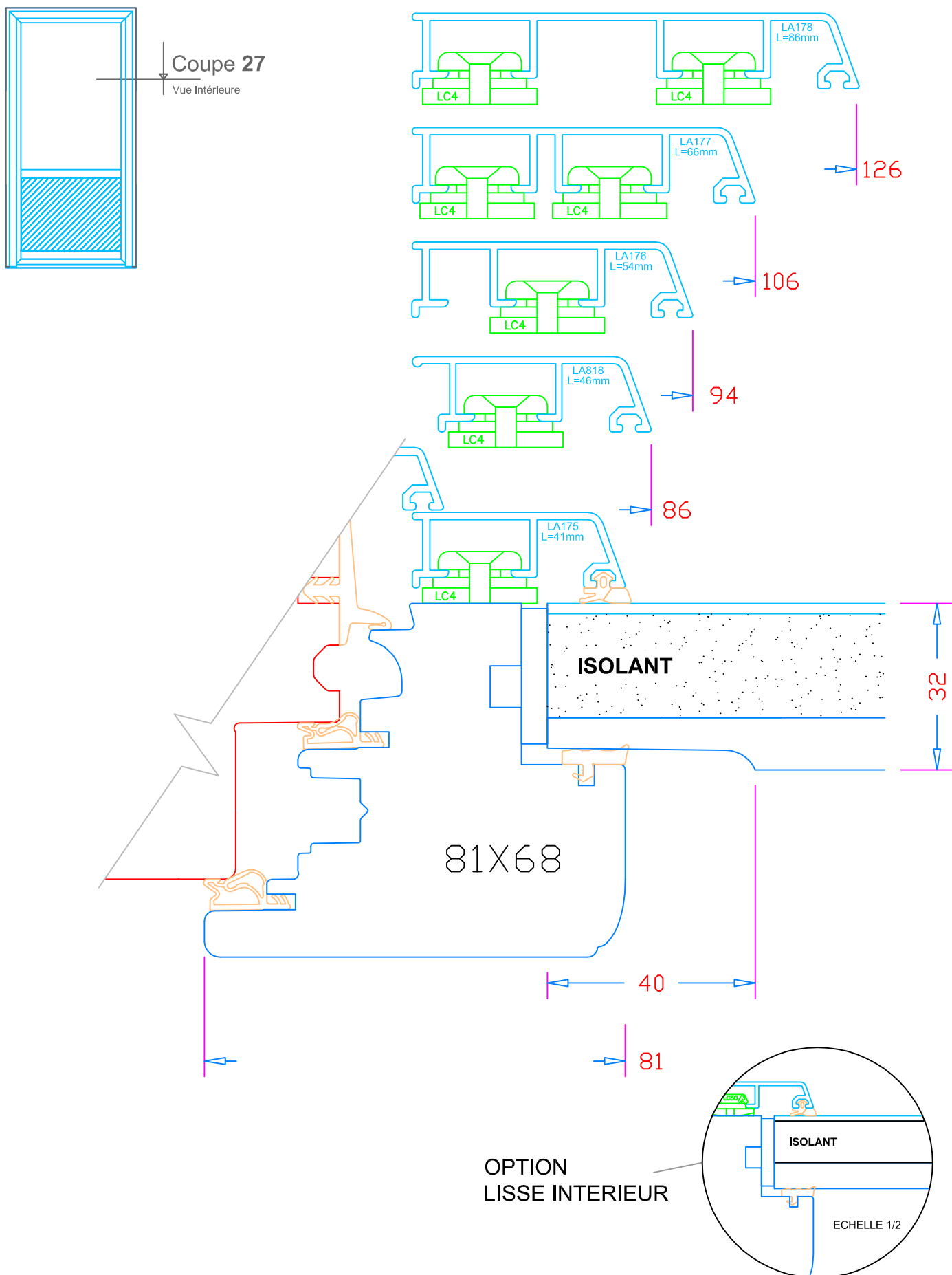

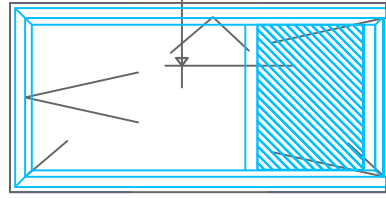

Coupe 28

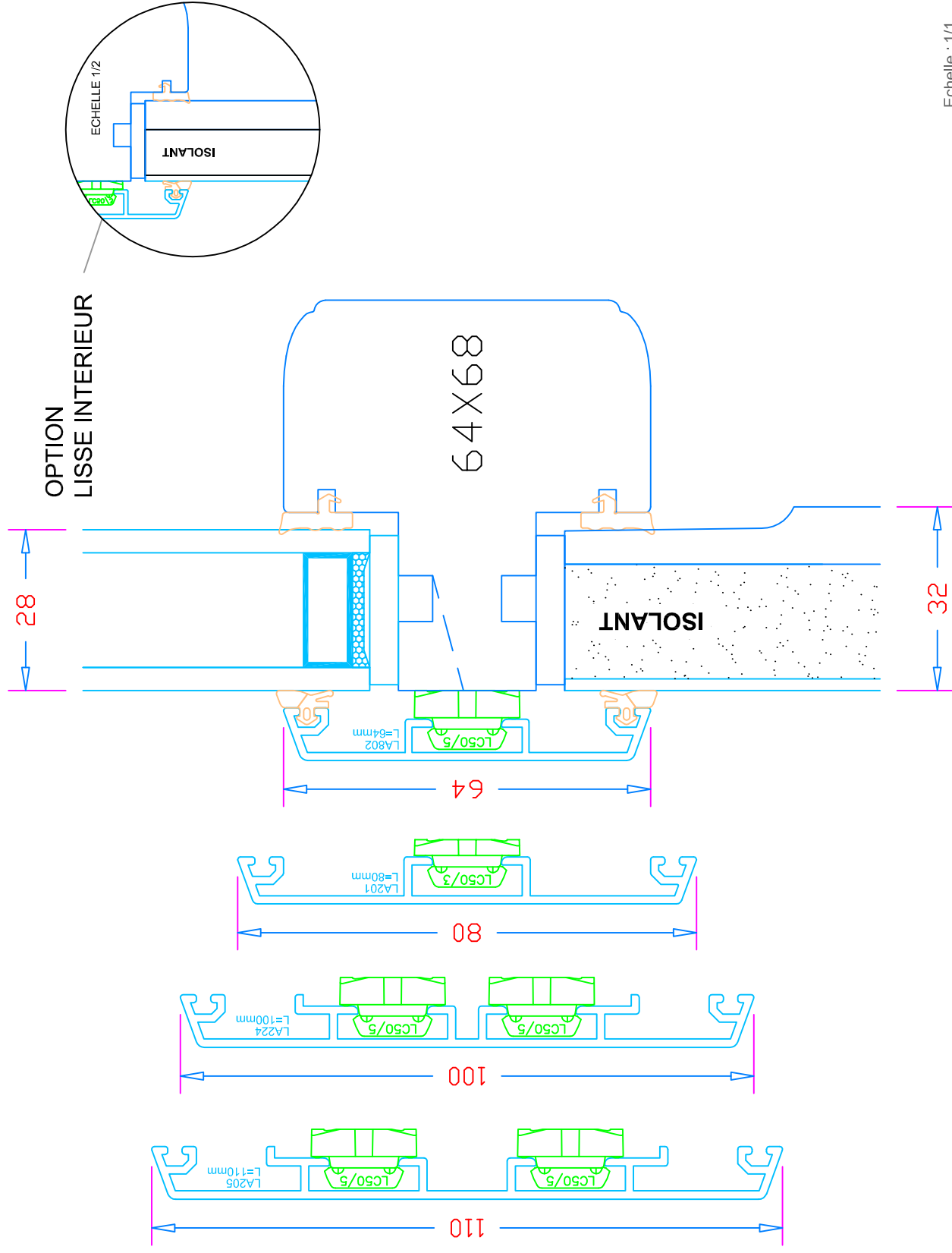

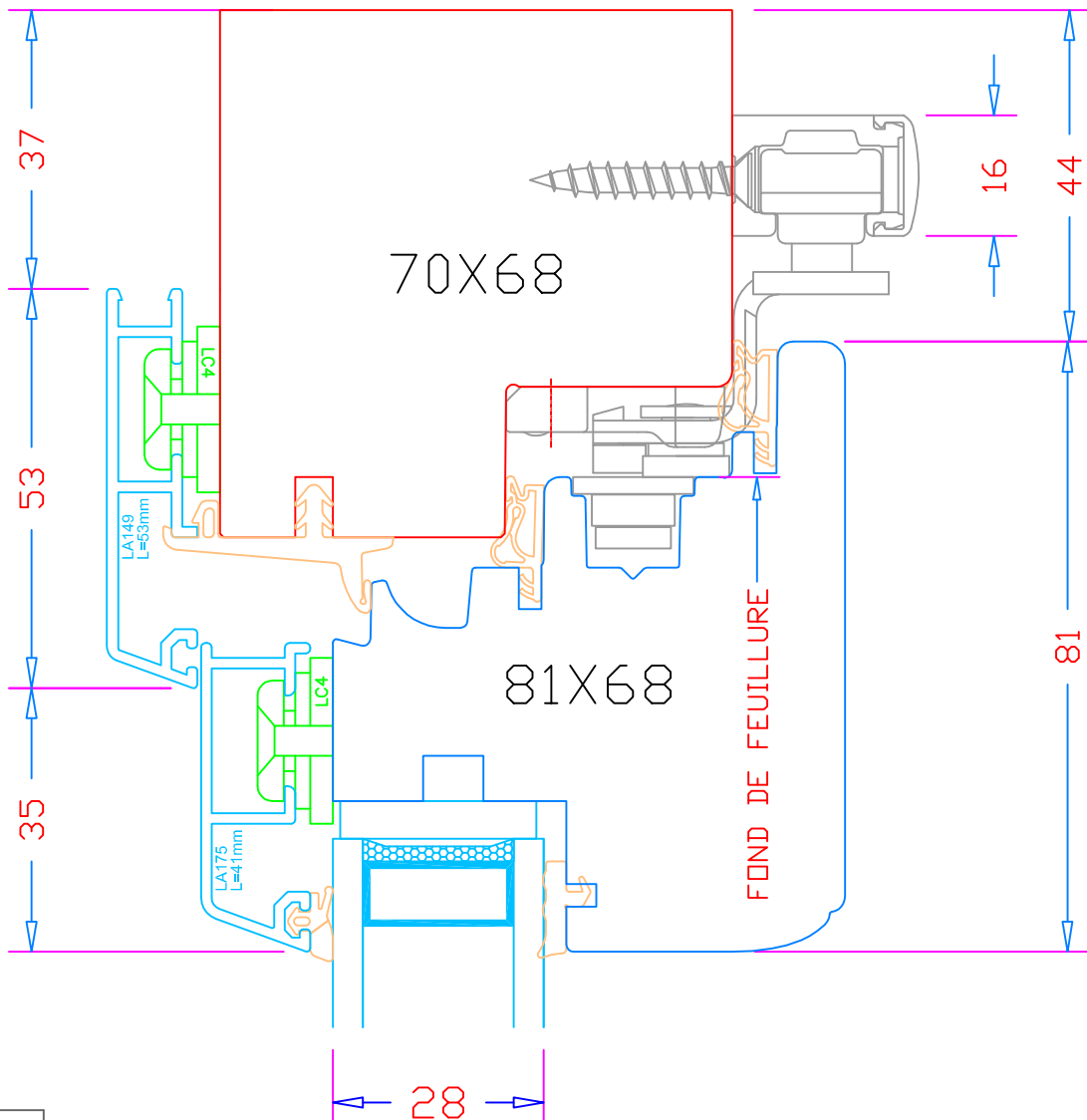
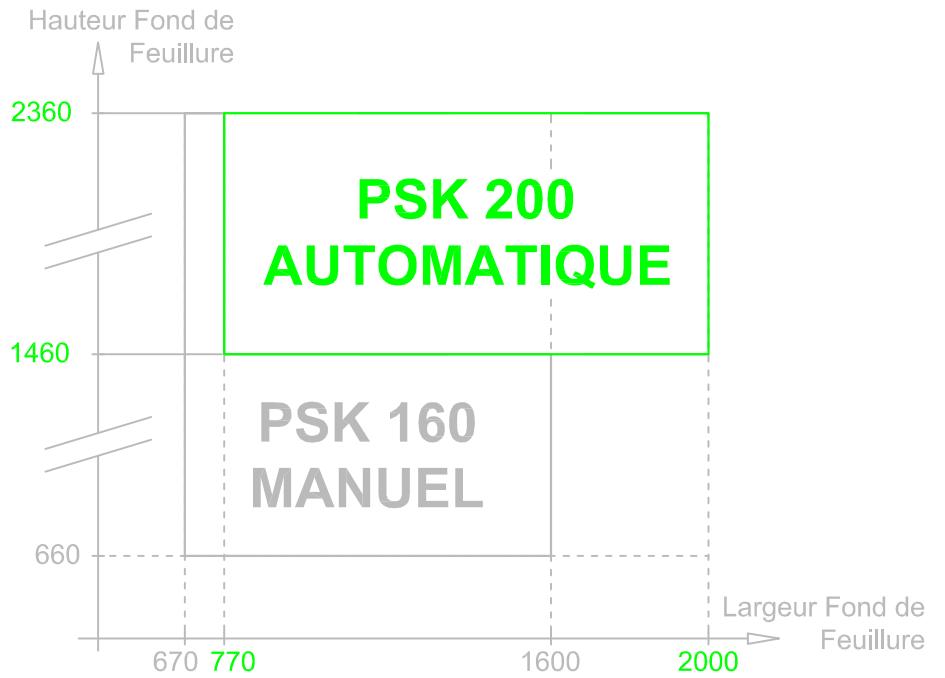
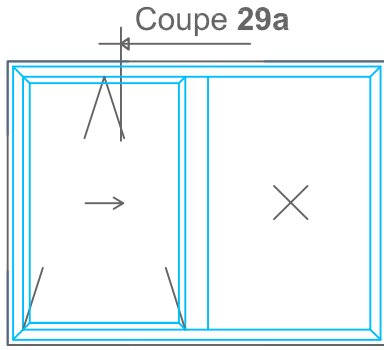

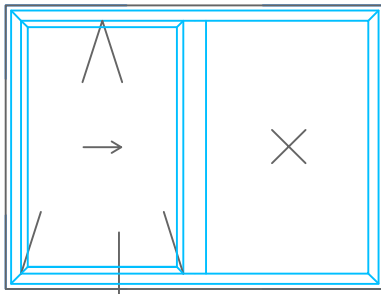

Coupe 29b

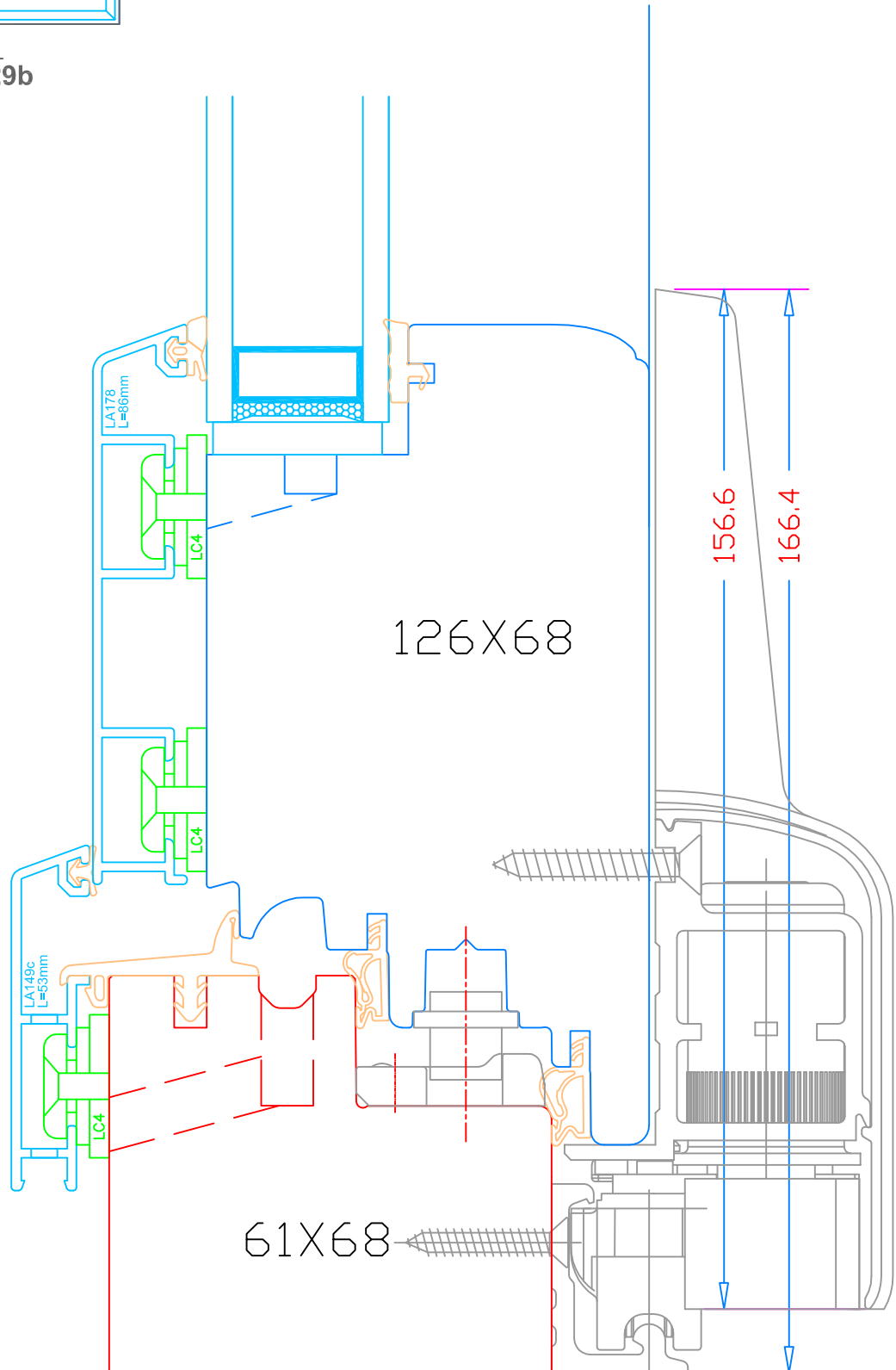

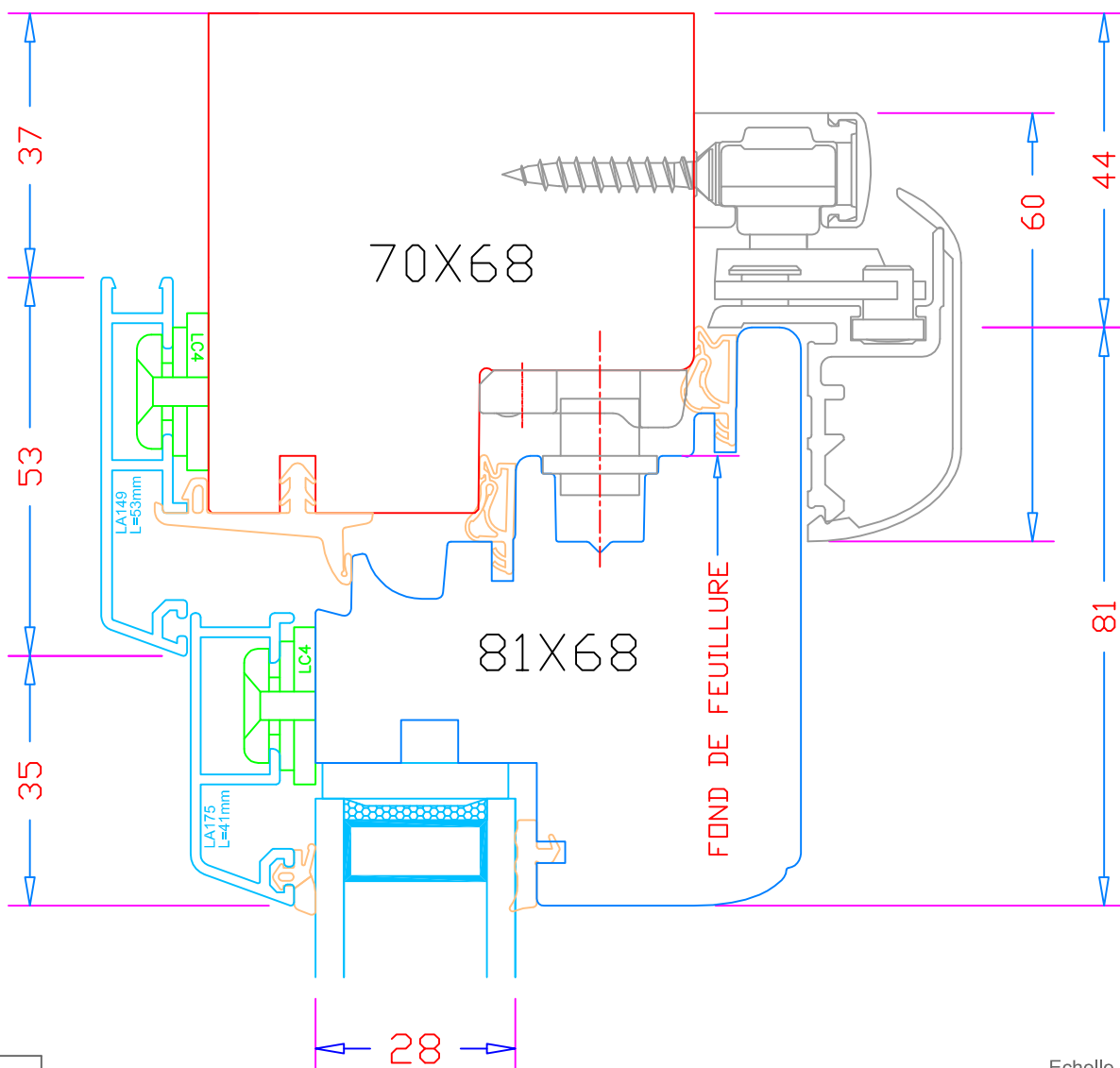
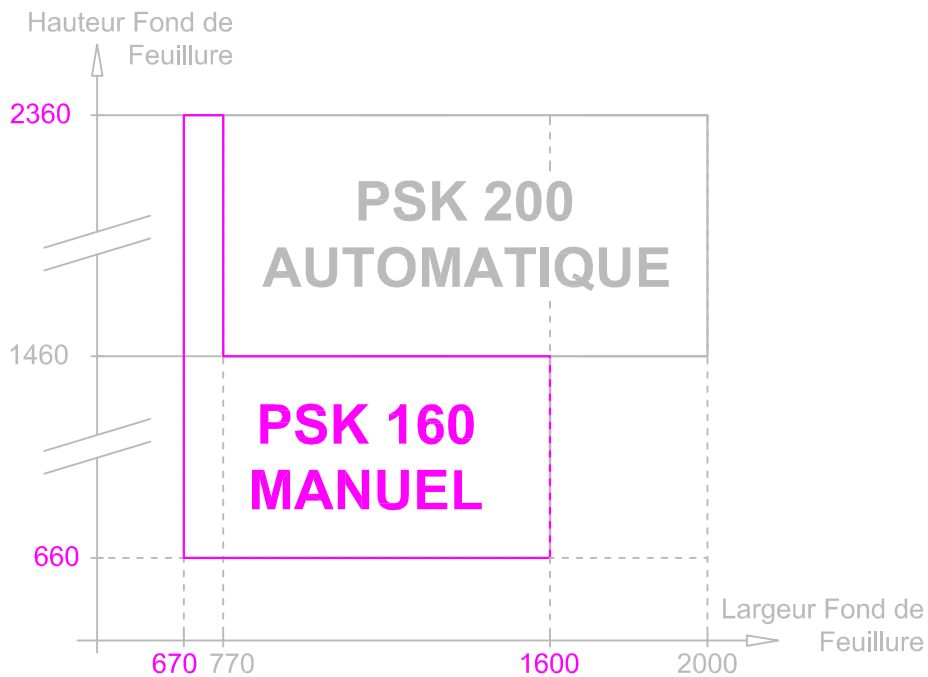
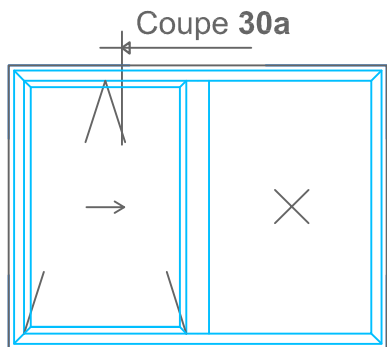

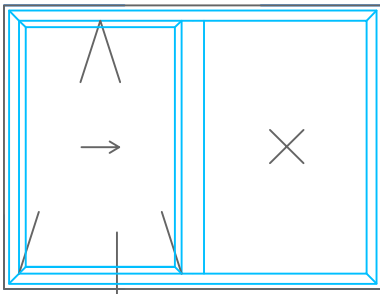

Coupe 30b

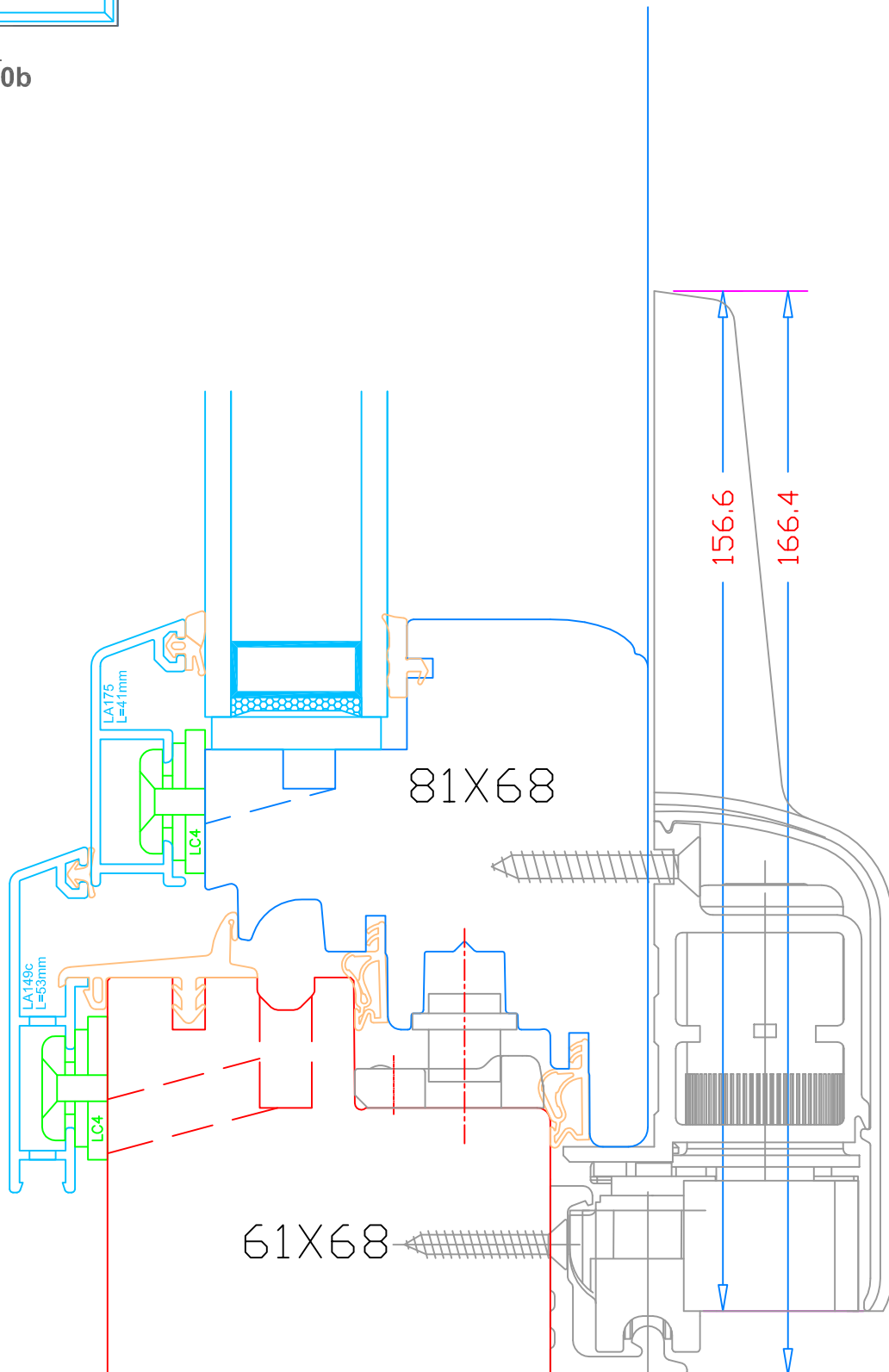

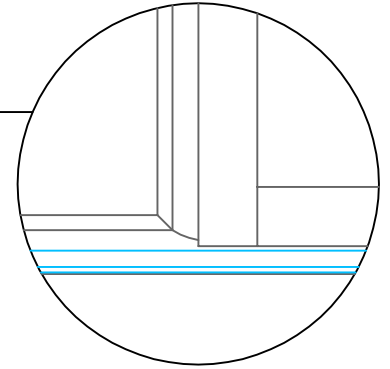
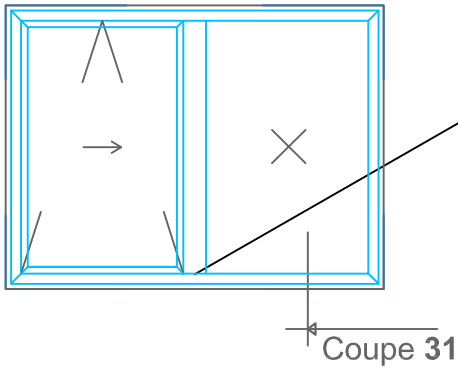

Vue intérieure
 Assemblage du meneau

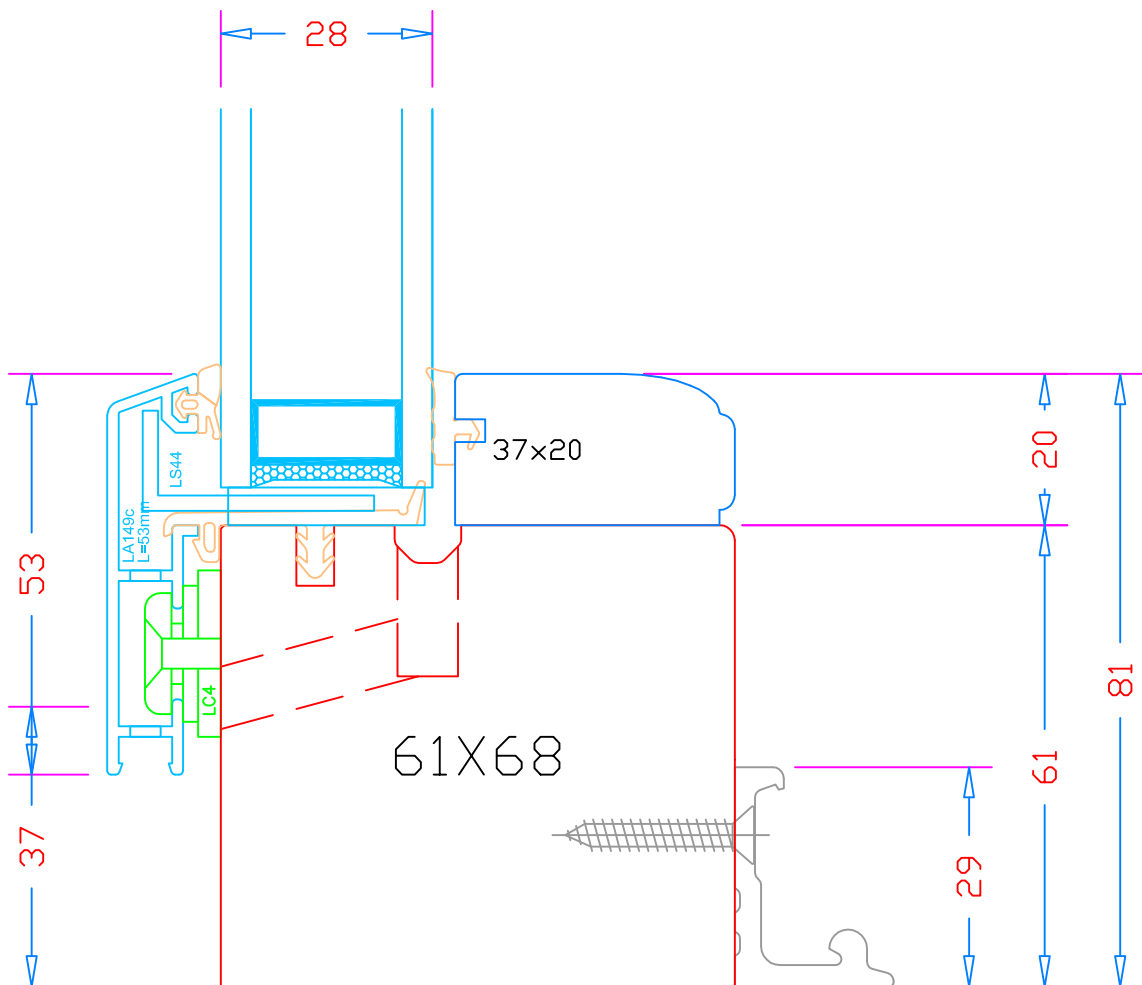

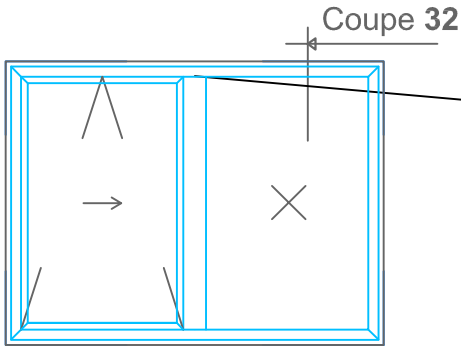

Vue intérieure
 Assemblage du meneau

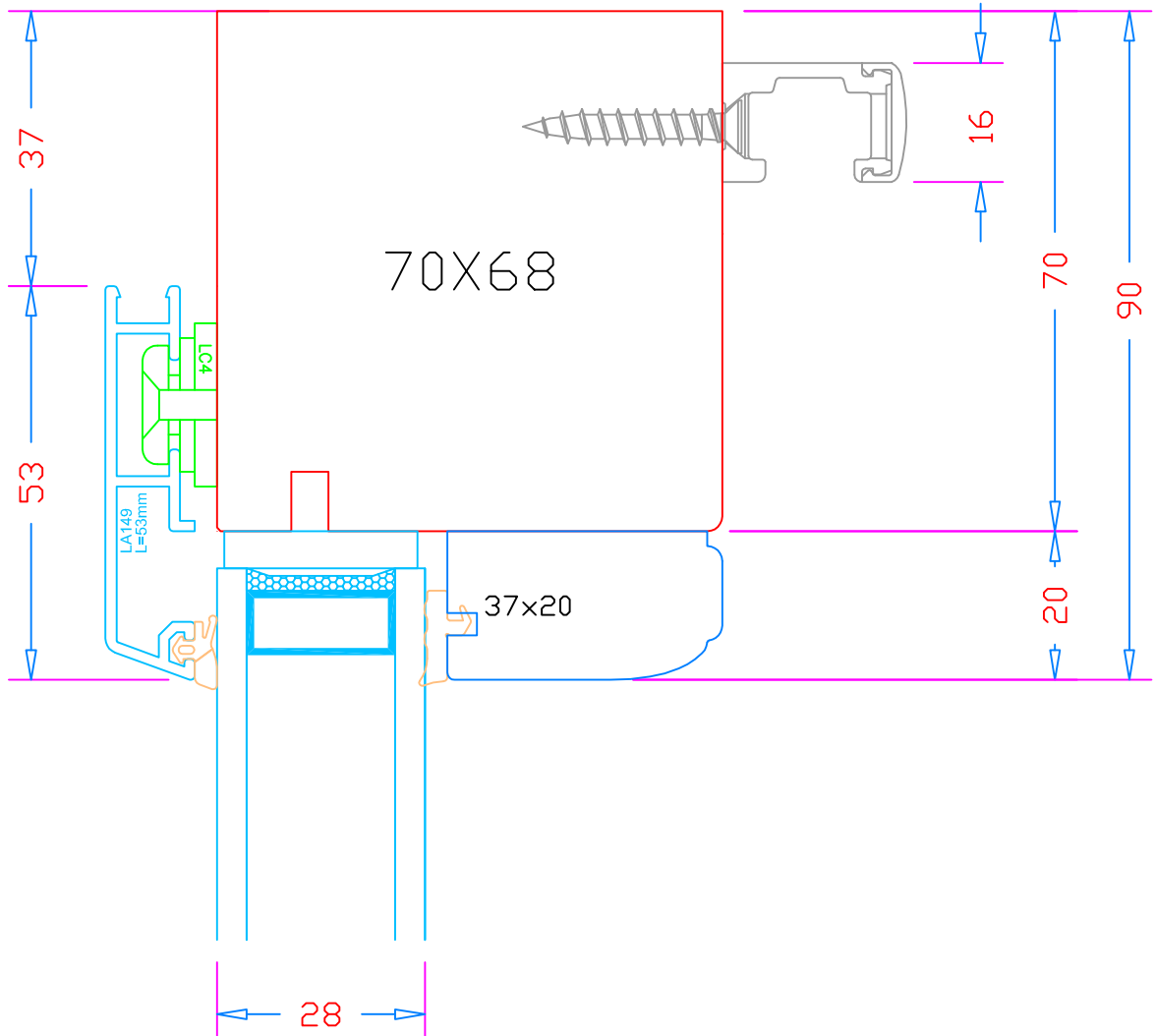
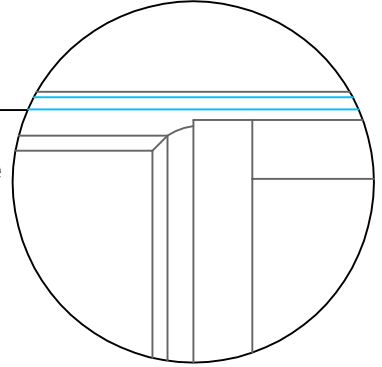

Coupe 33

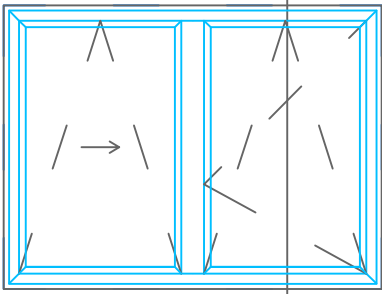

POIGNEE EXT



Attention, coulissant basculant avec poignée saillie réduite à l'extérieure fixe latéral obligatoire.

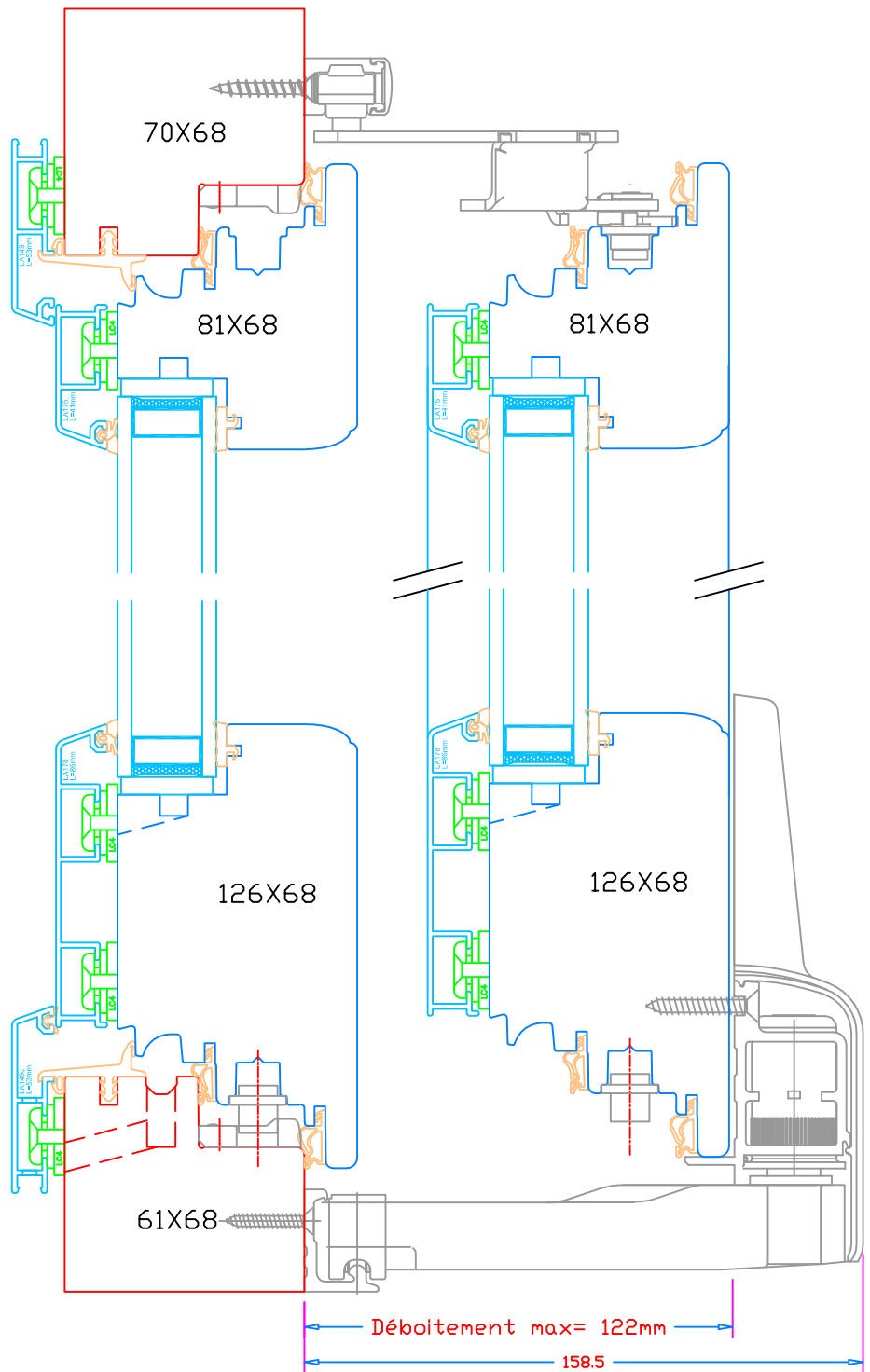

Coupes Ouverture Extérieure

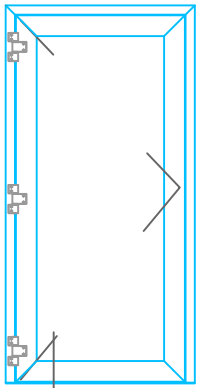

Coupe 34

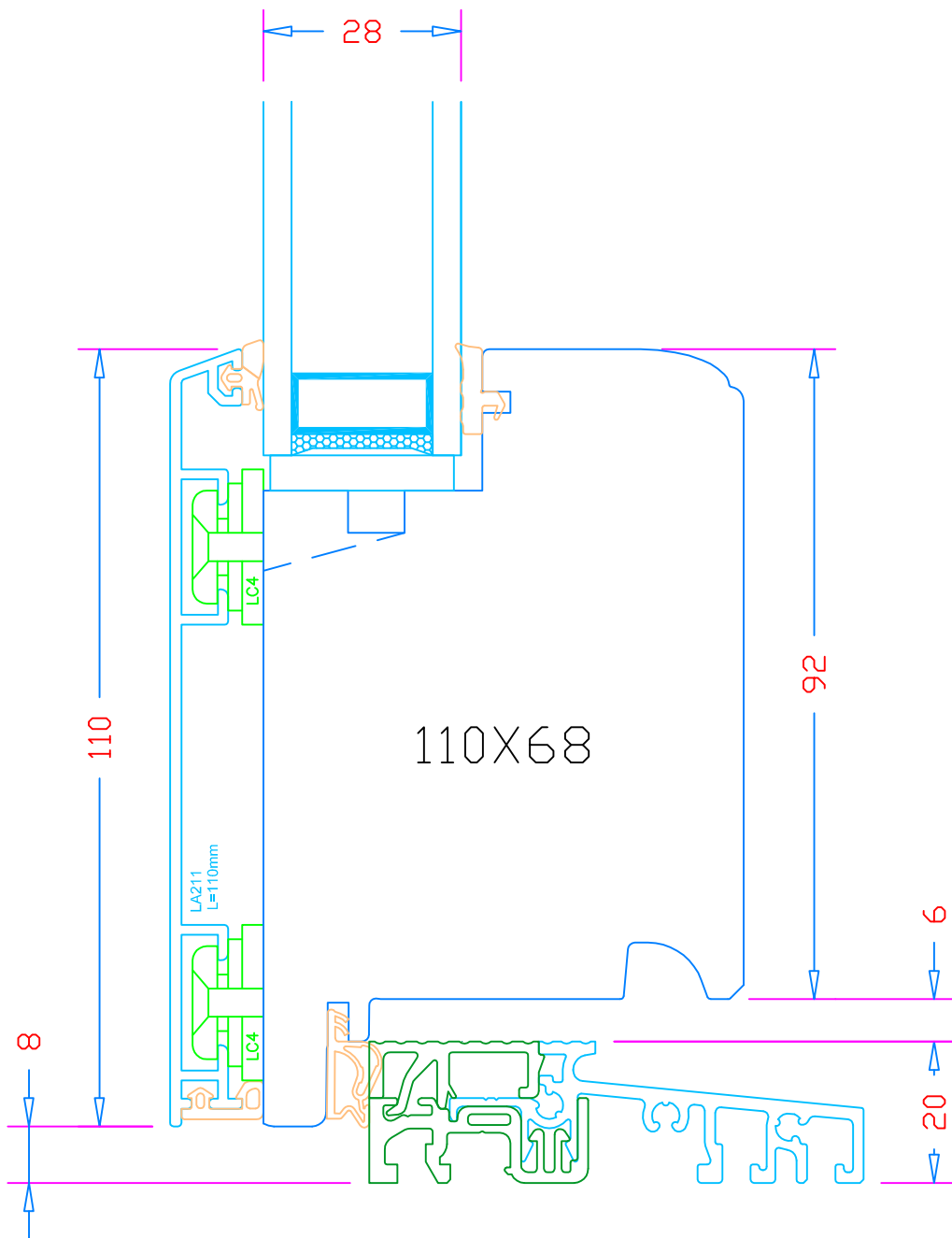

Coupe 35

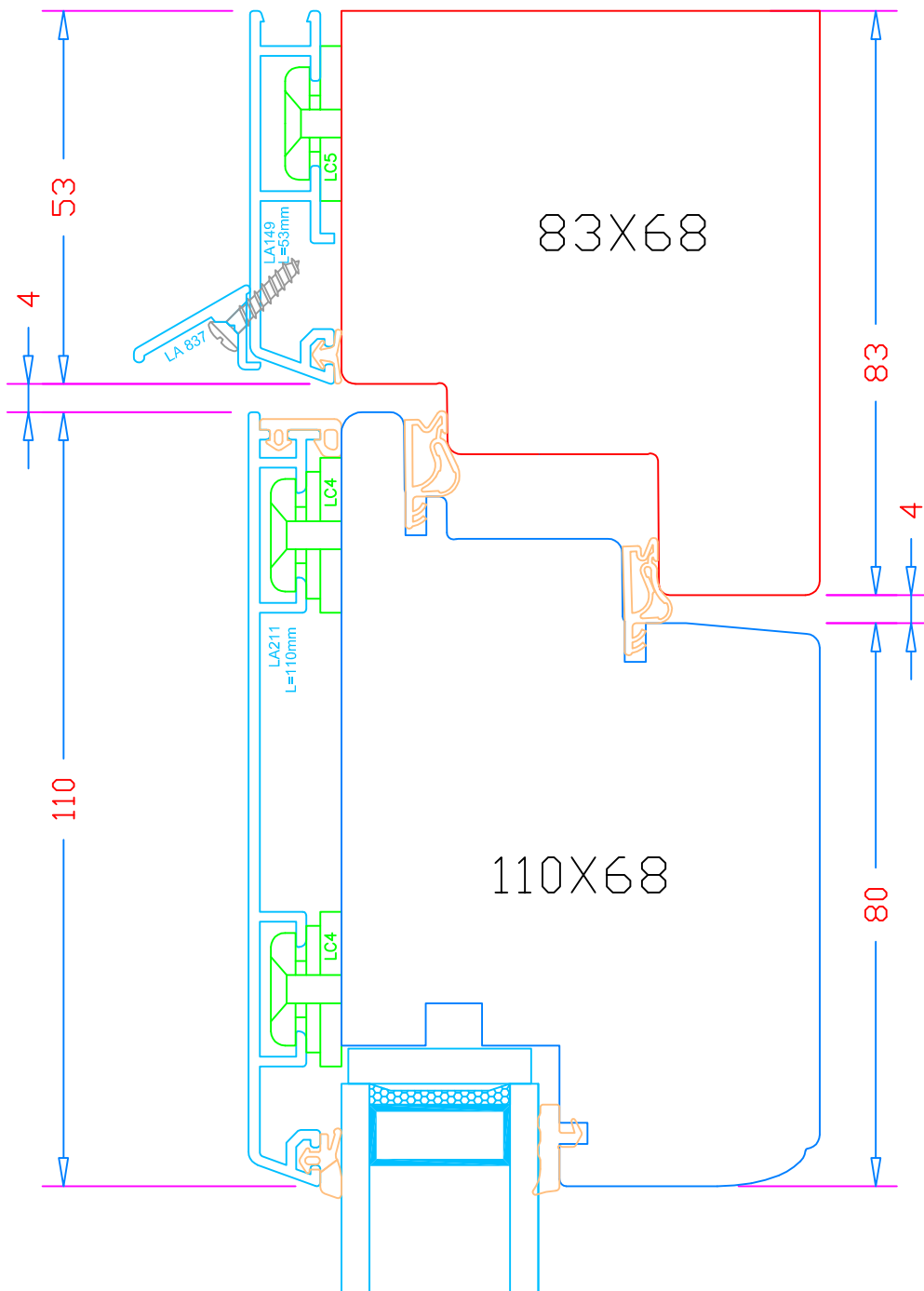
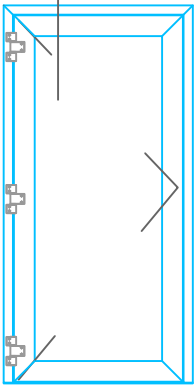

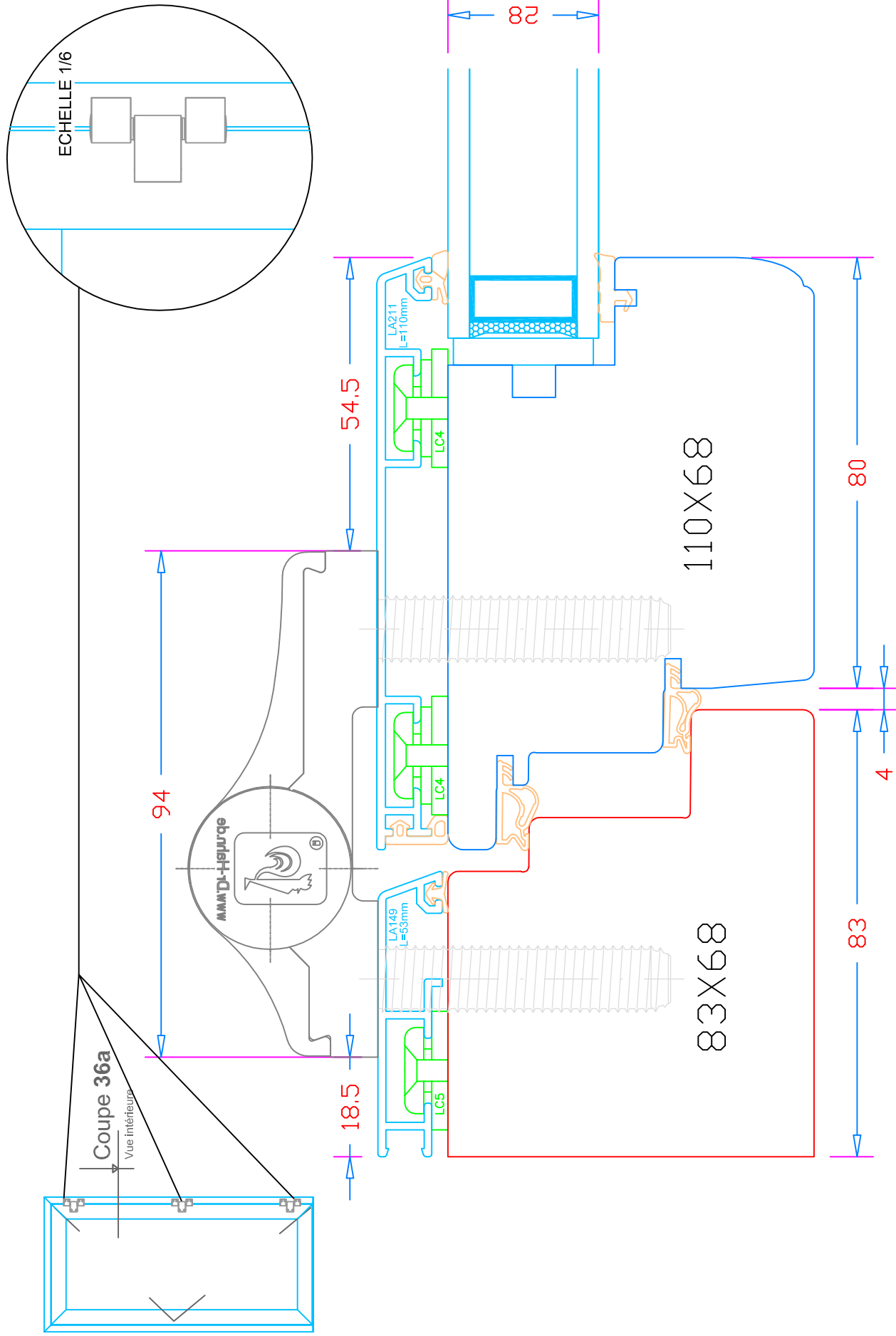

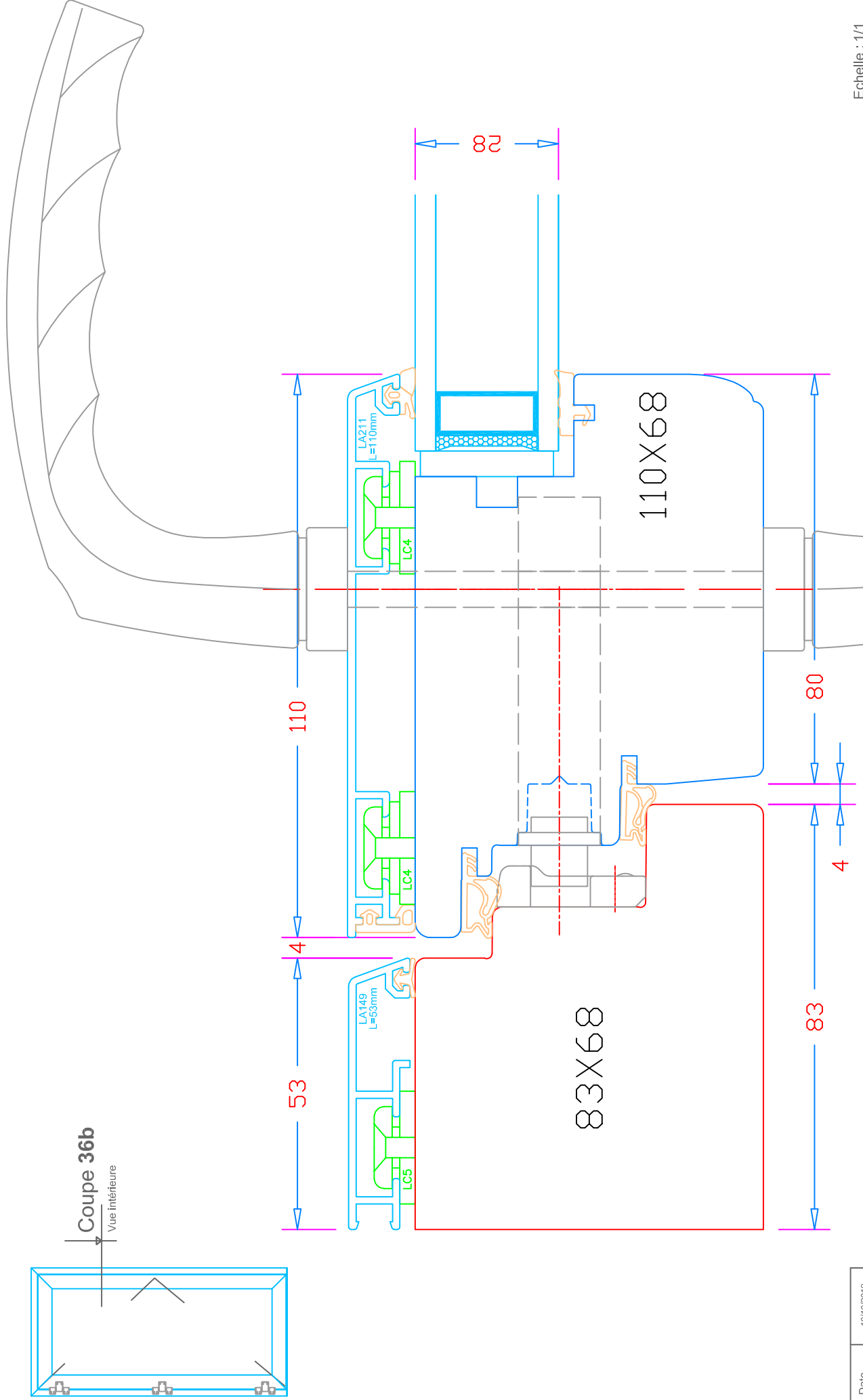

Coupe 37

Vue intérieure

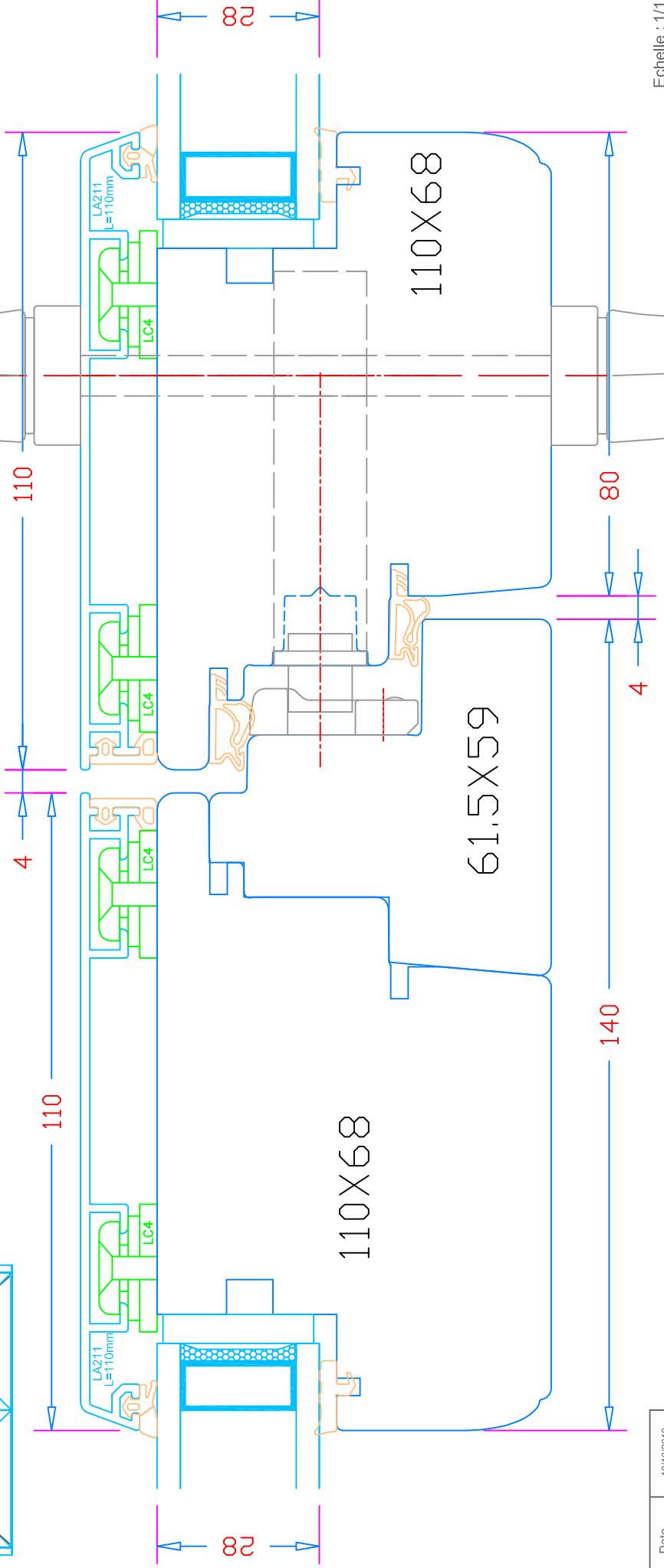
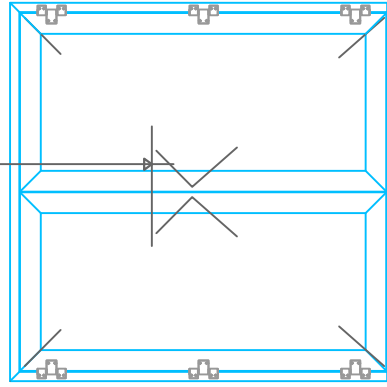

Coupes Passif

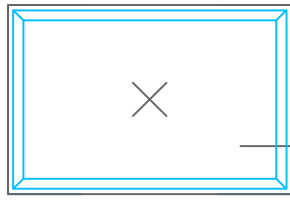

Coupe 38

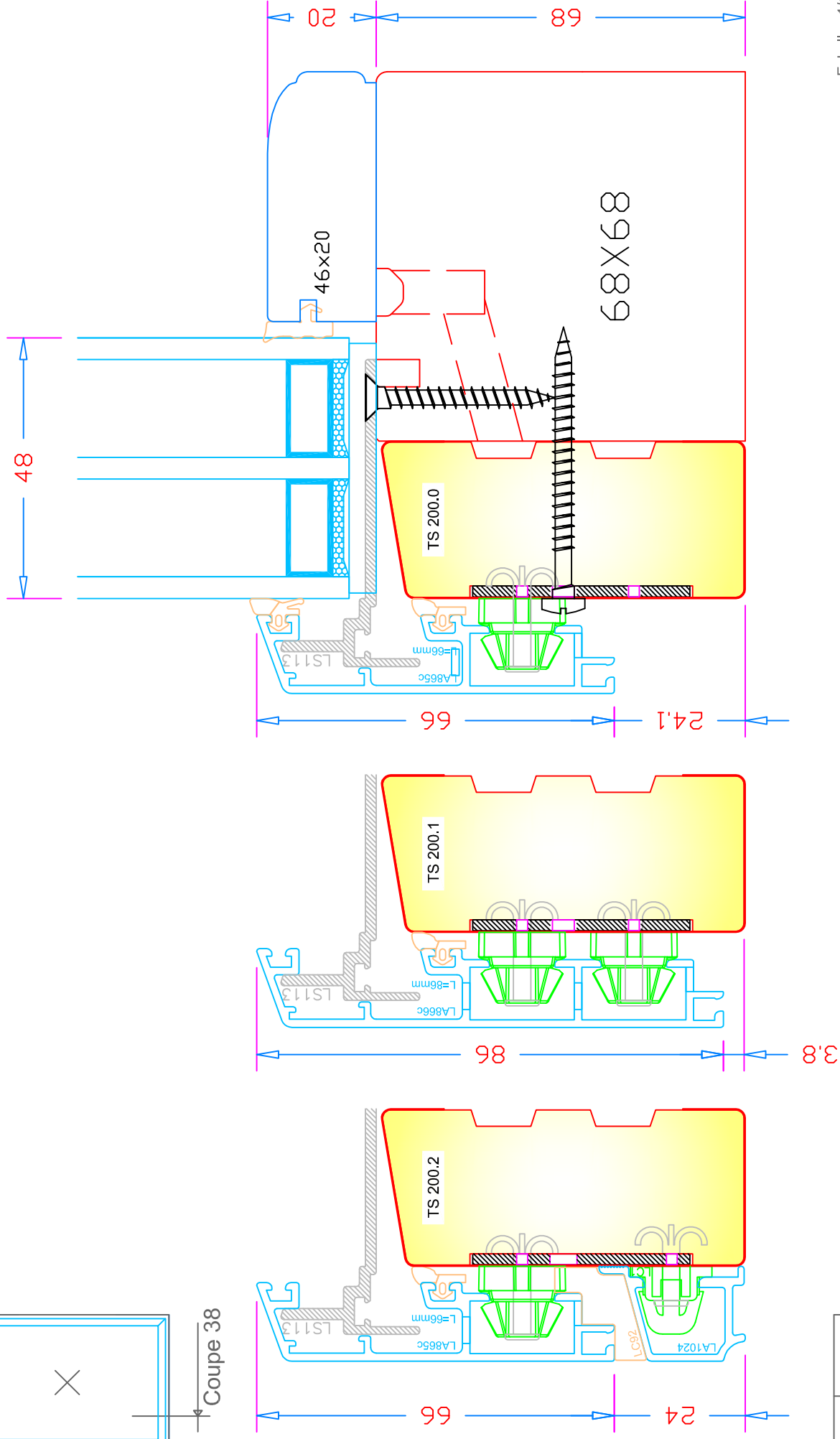

Coupe 39

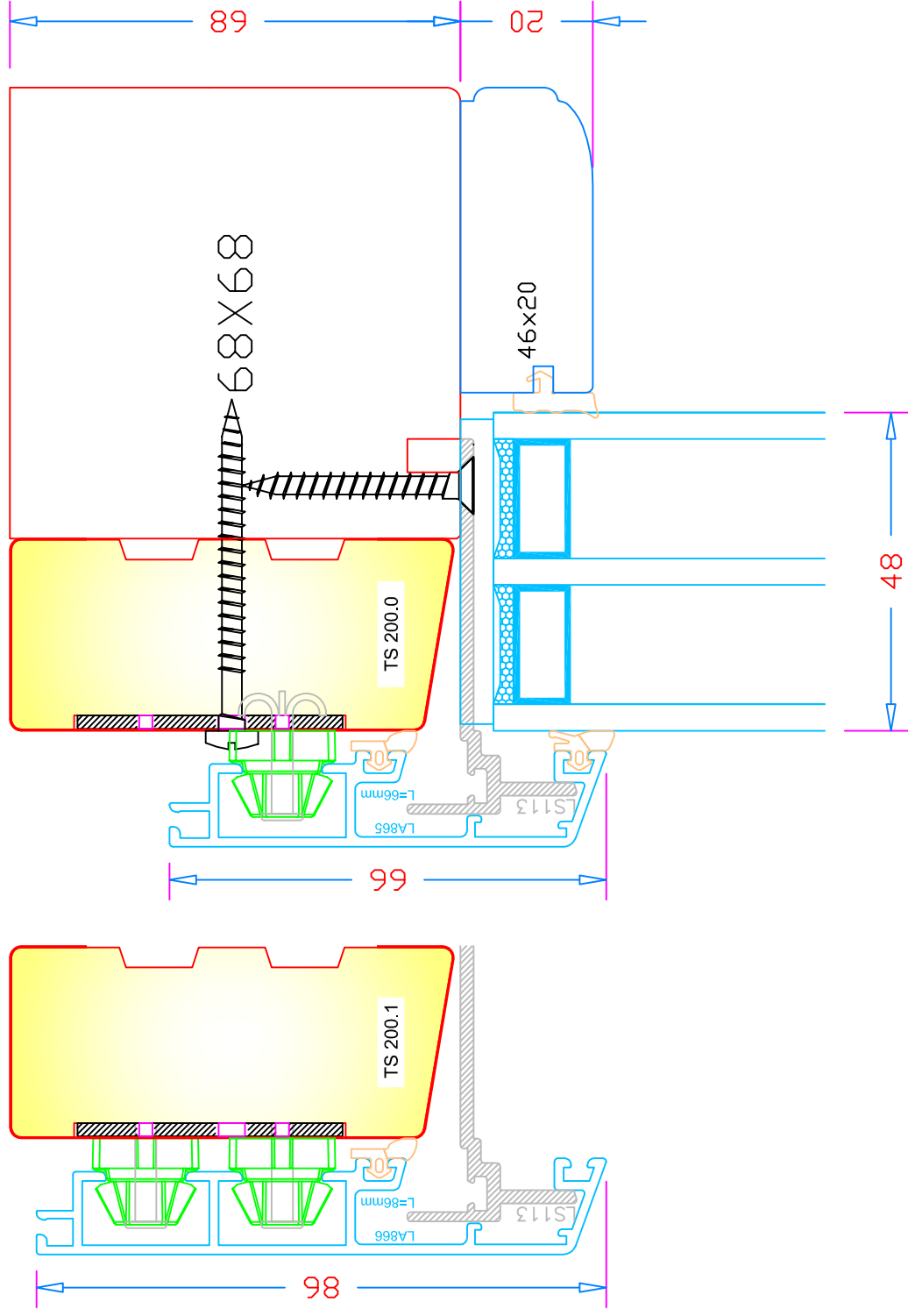
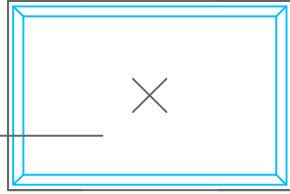

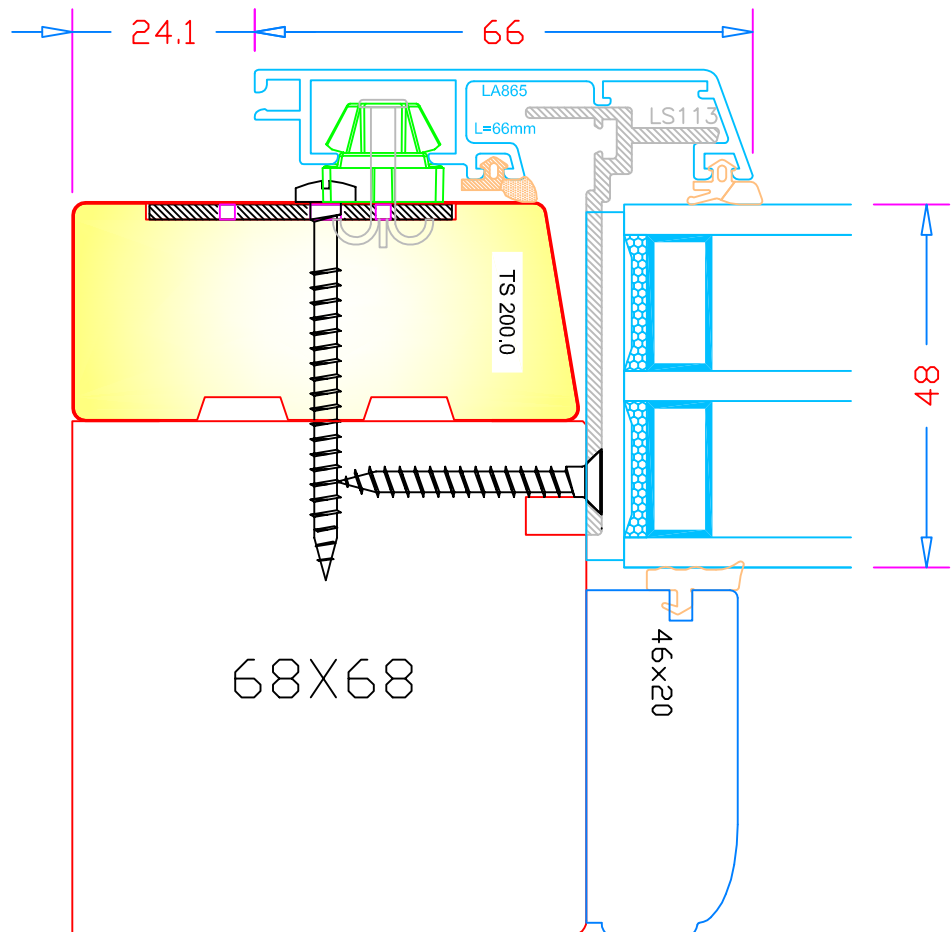
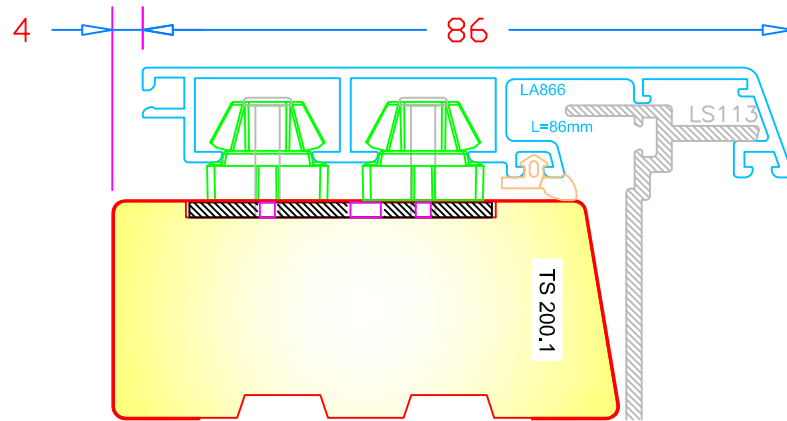
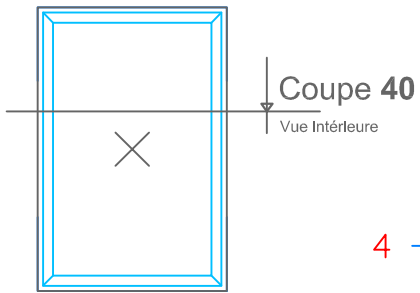

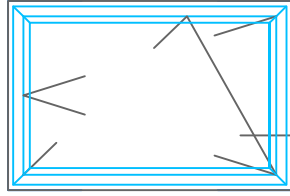

Coupe 41a

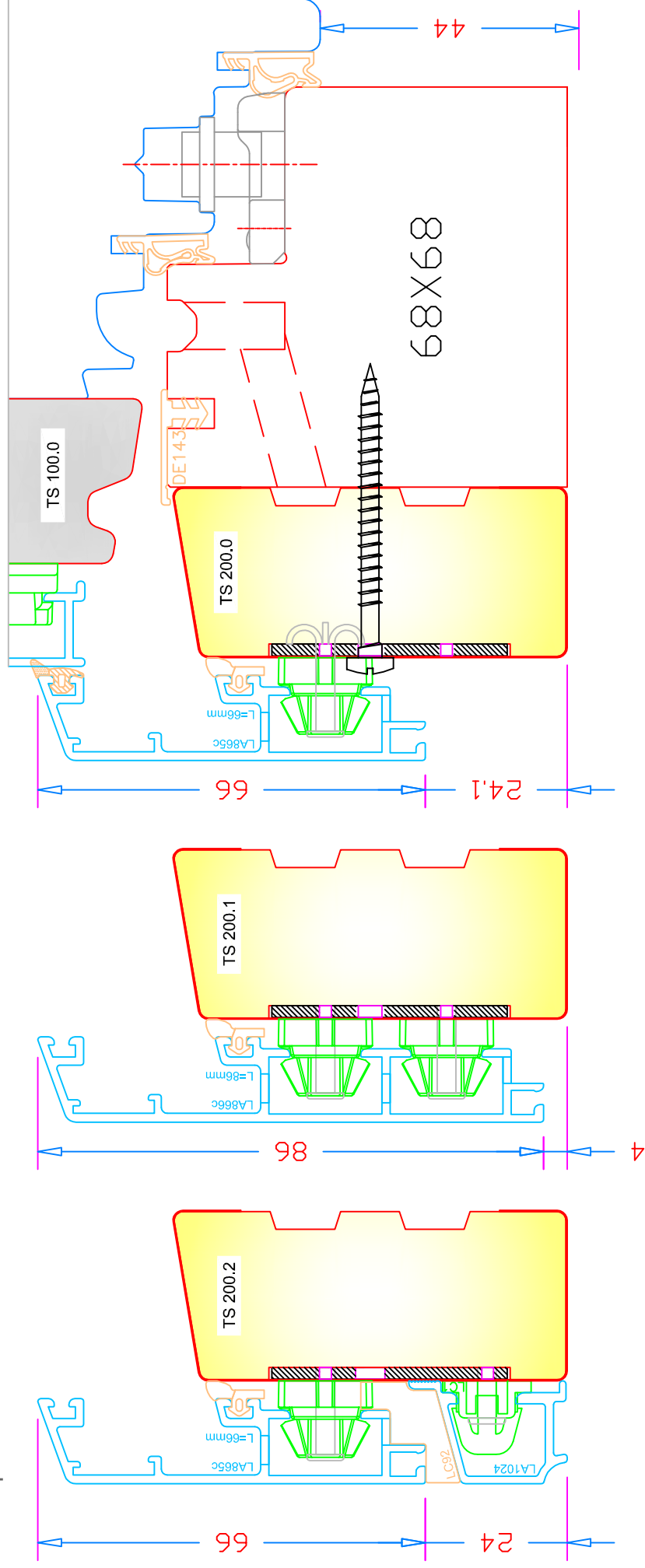

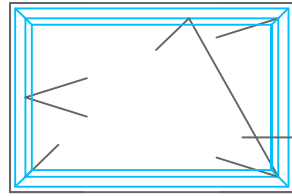

Coupe 41b

Largueur possible de bavette

50mm	150mm	225mm	320mm
70mm	165mm	240mm	360mm
90mm	180mm	260mm	400mm
110mm	195mm	280mm	
130mm	210mm	300mm	

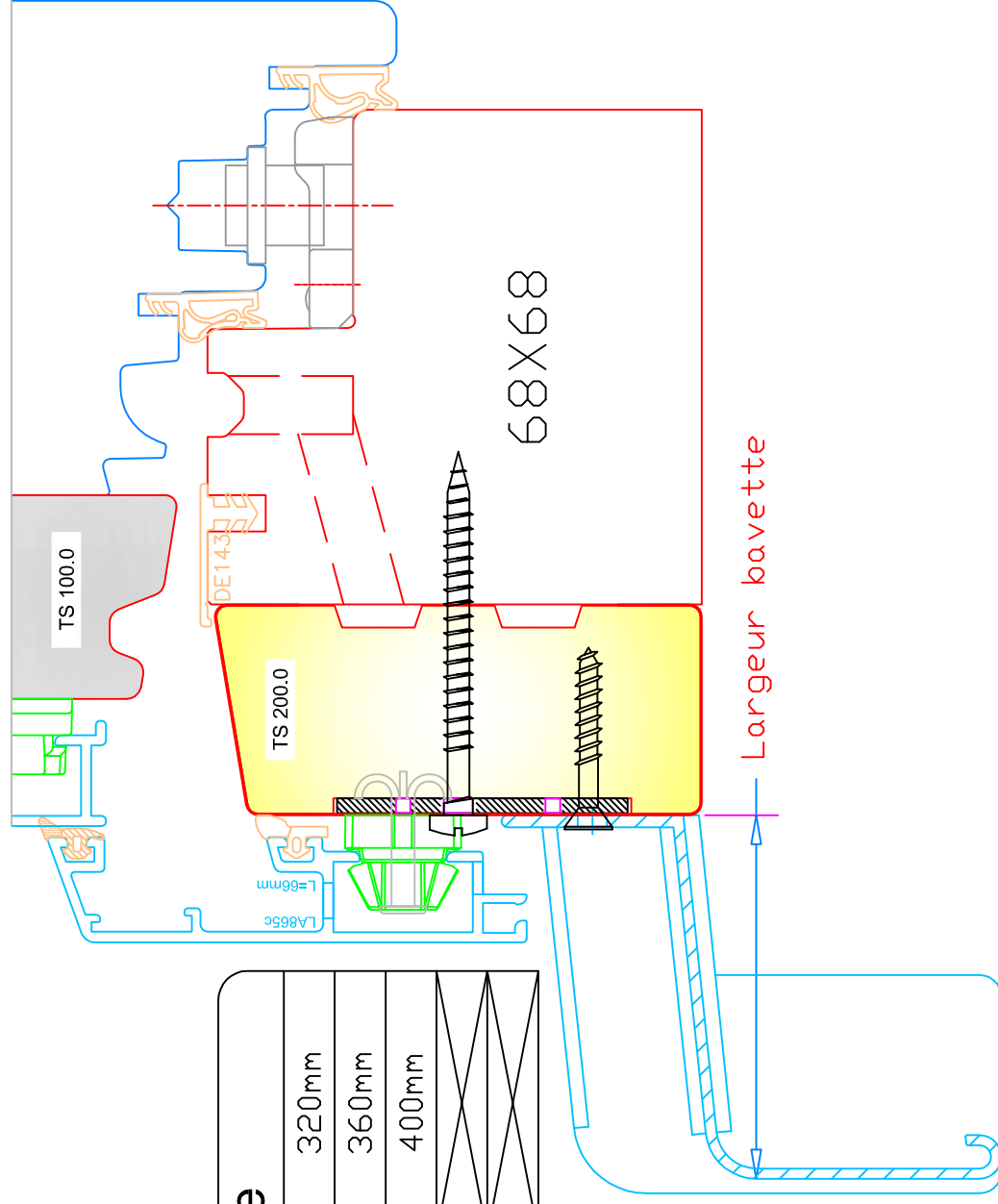

Ouvrant
Traverse haute (Détail du dormant)

Coupe 42

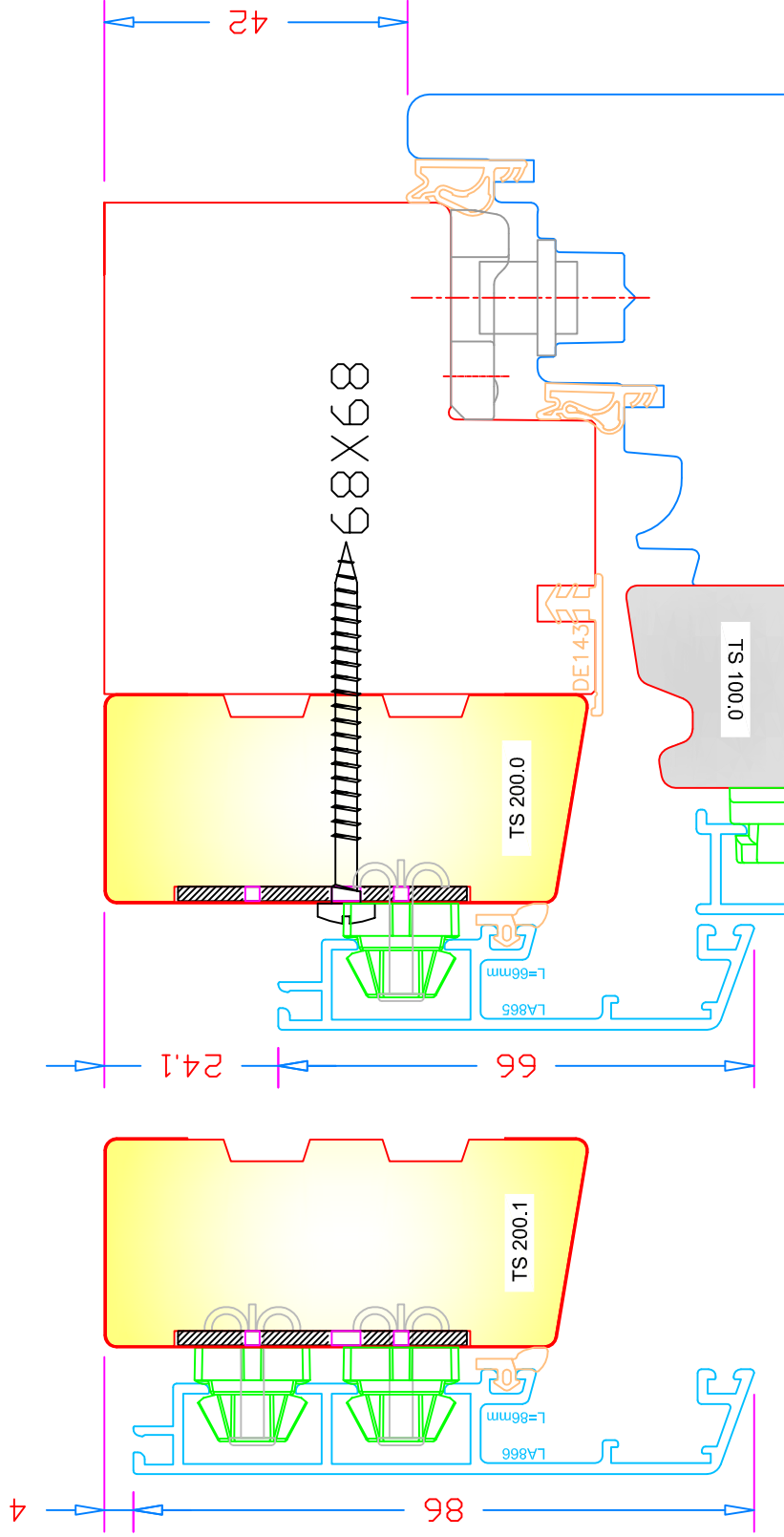
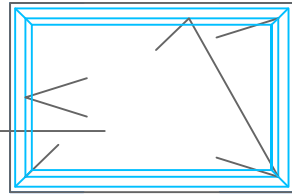

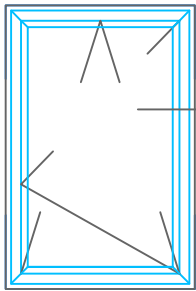

Coupe 43
 Vue Intérieure

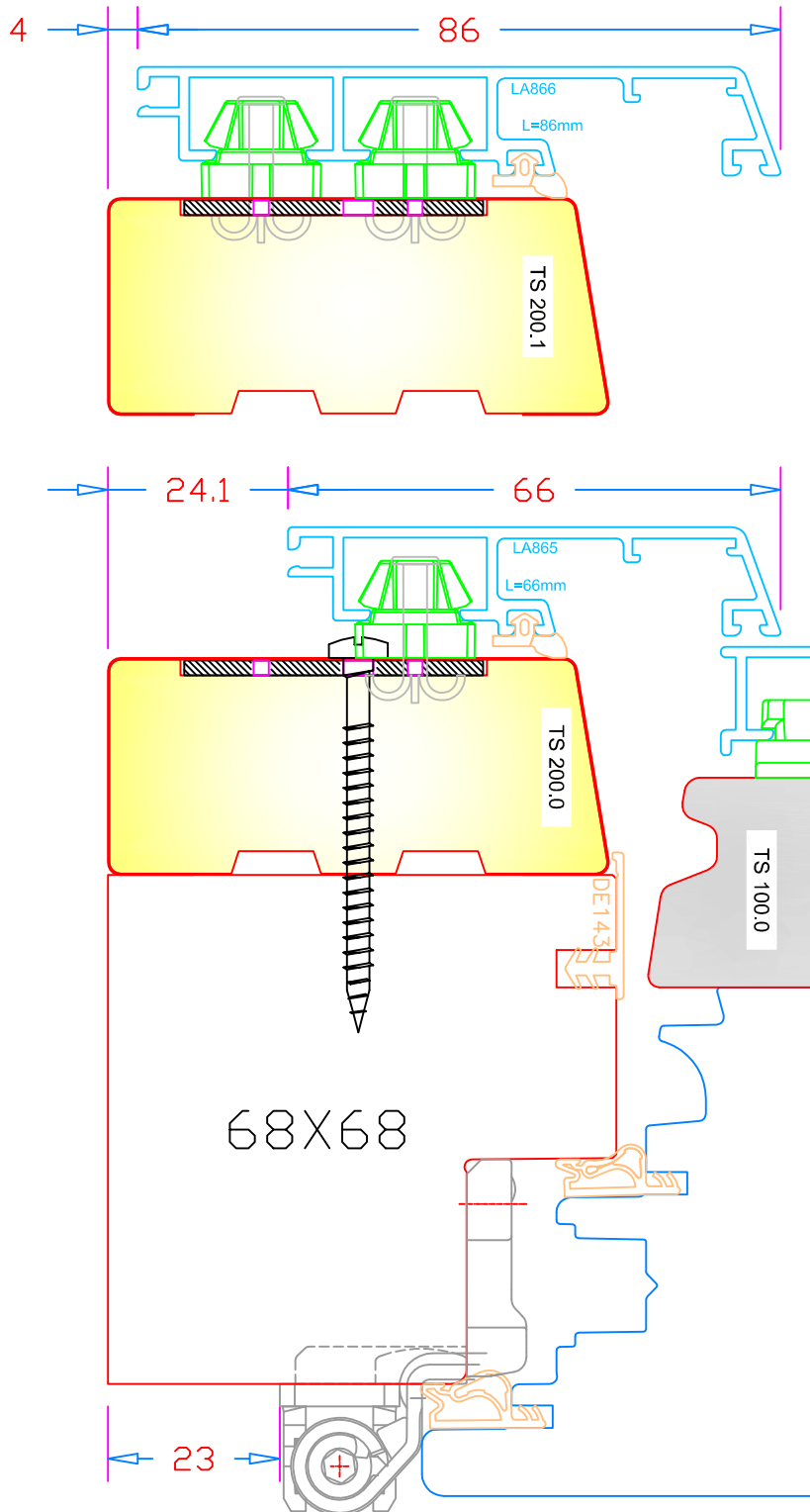

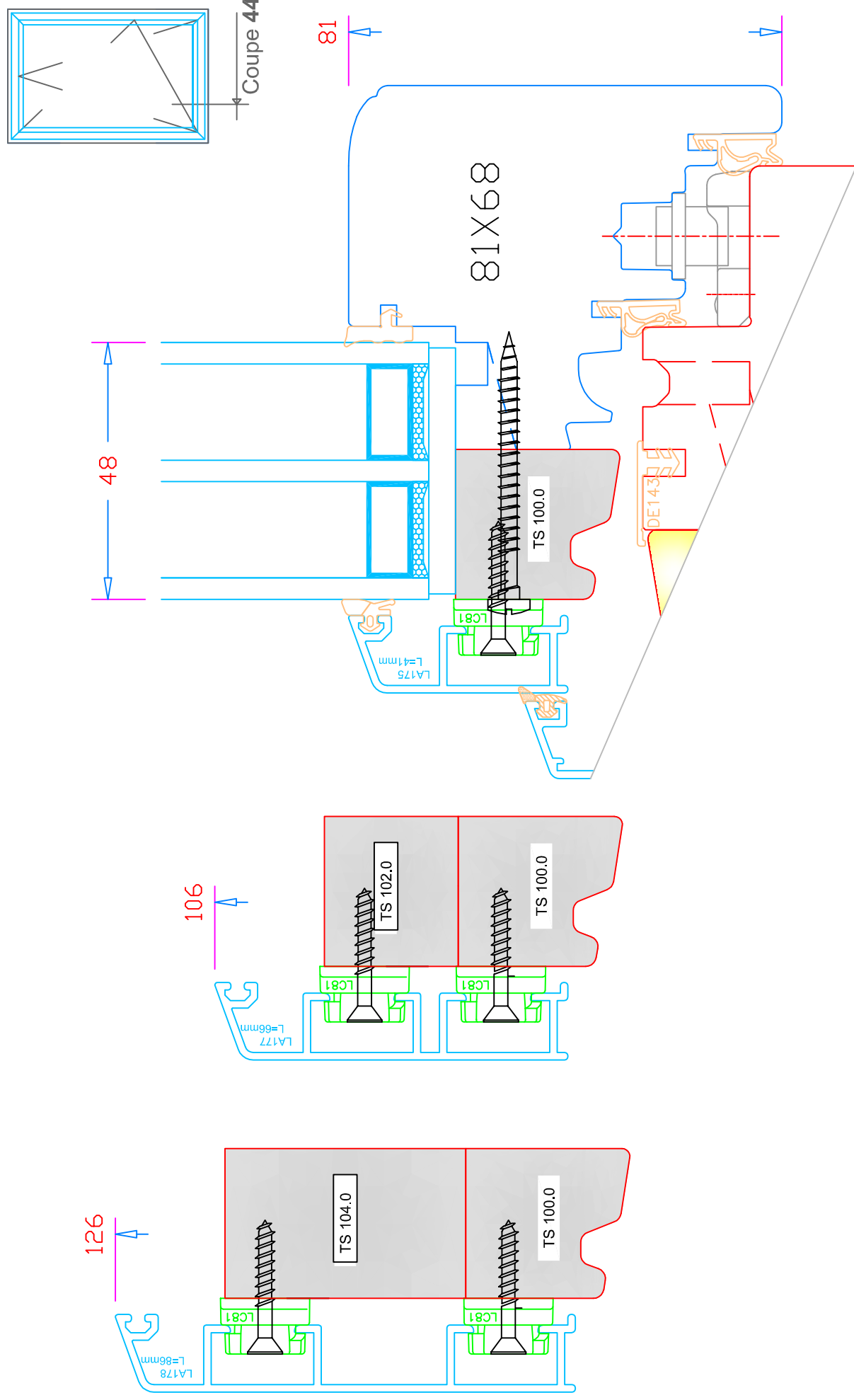

Coupe 45

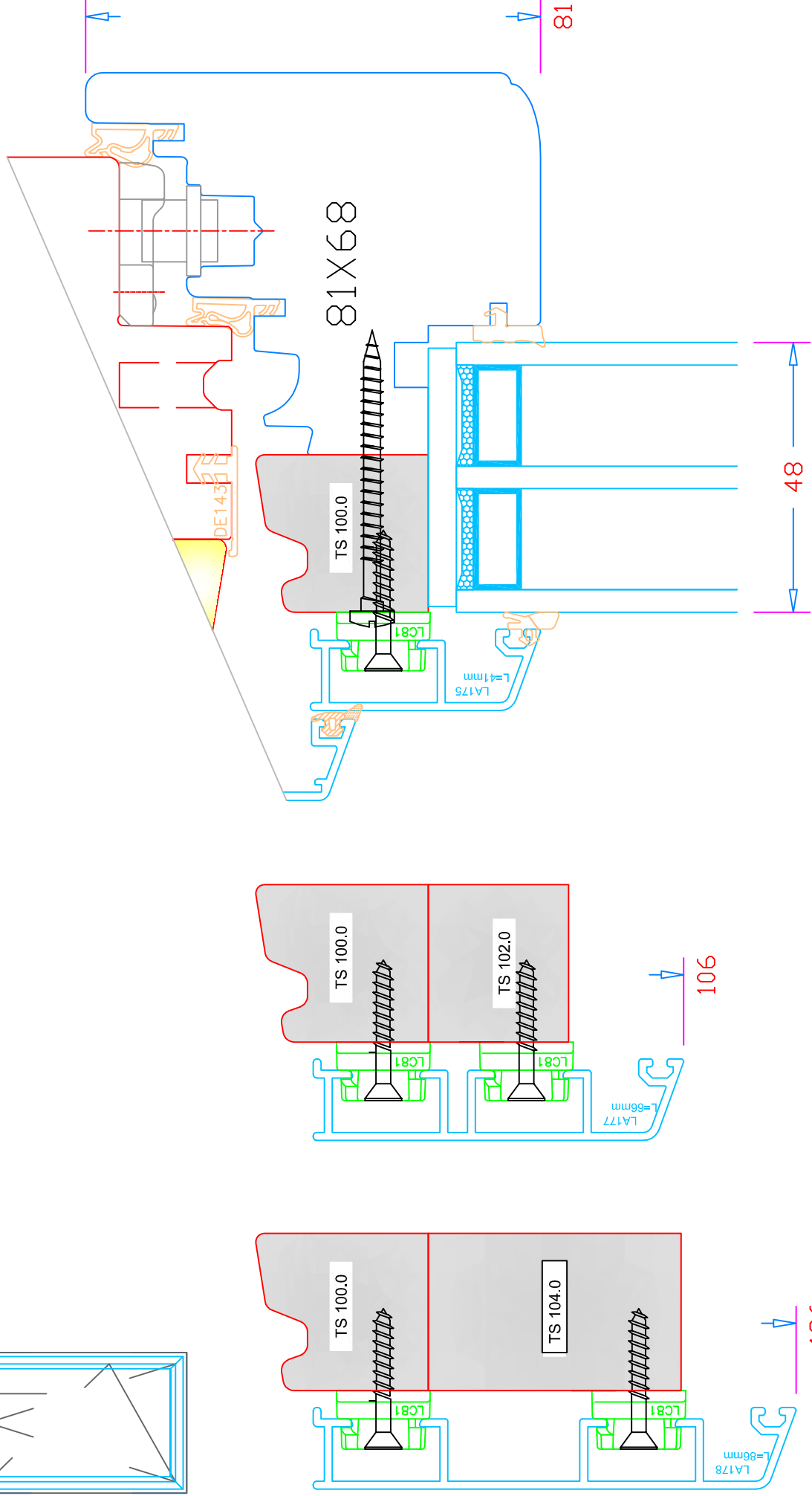
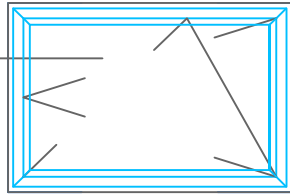

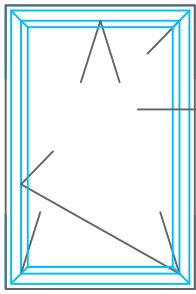

Coupe 46
Vue Intérieure

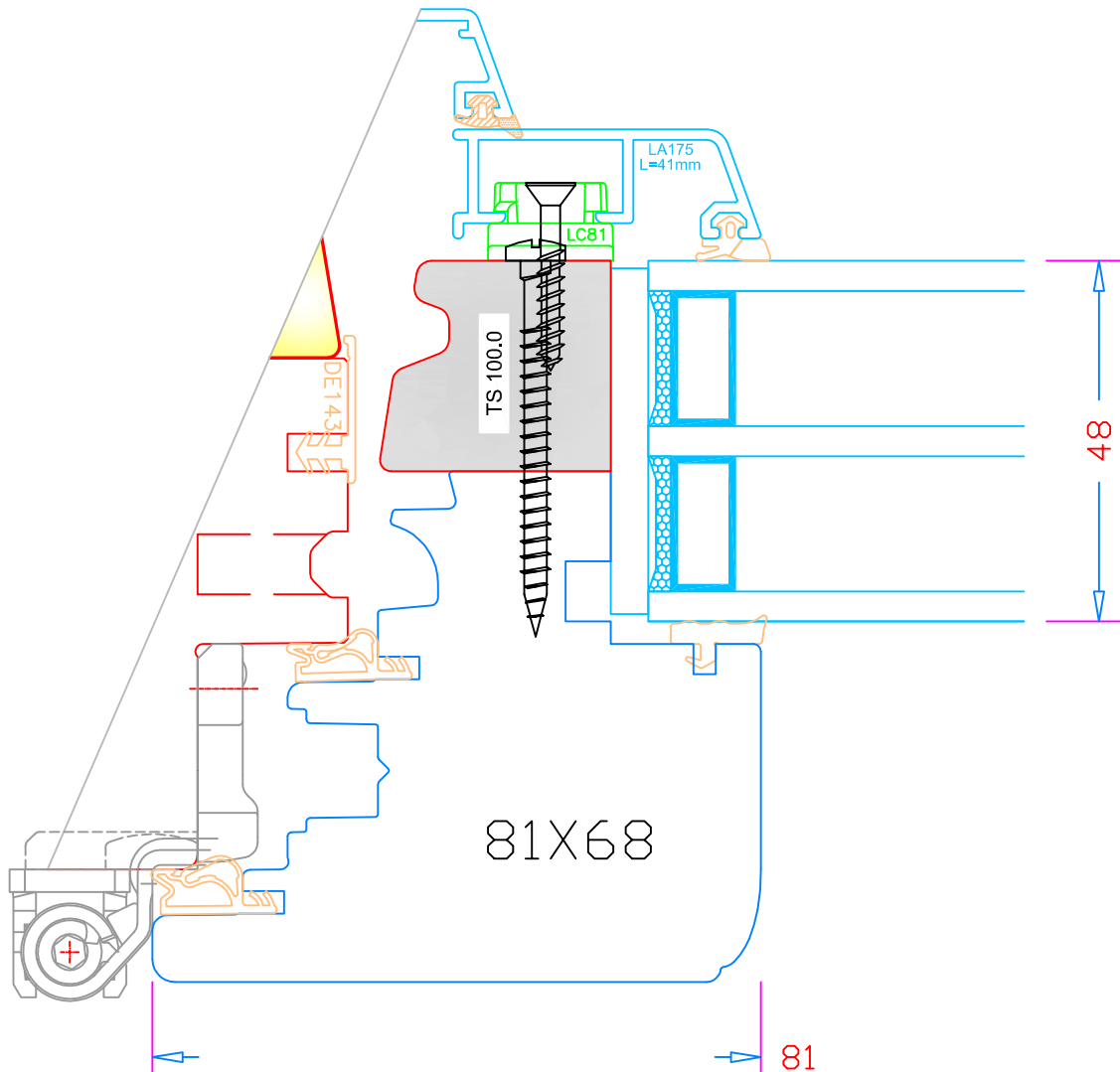
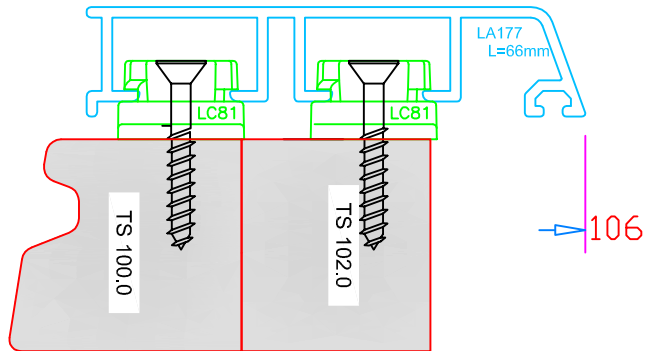
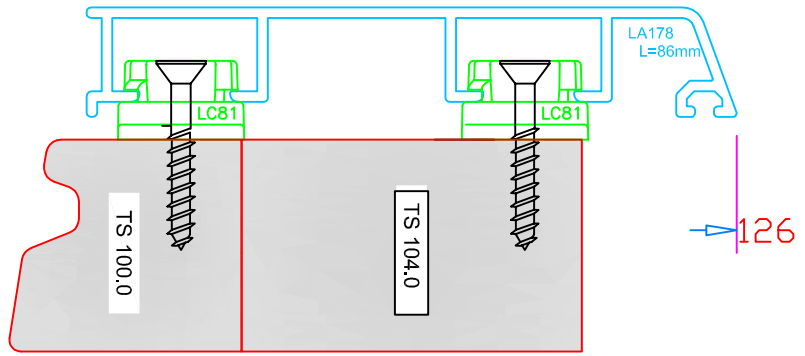

Coupe 47
 Vue intérieure

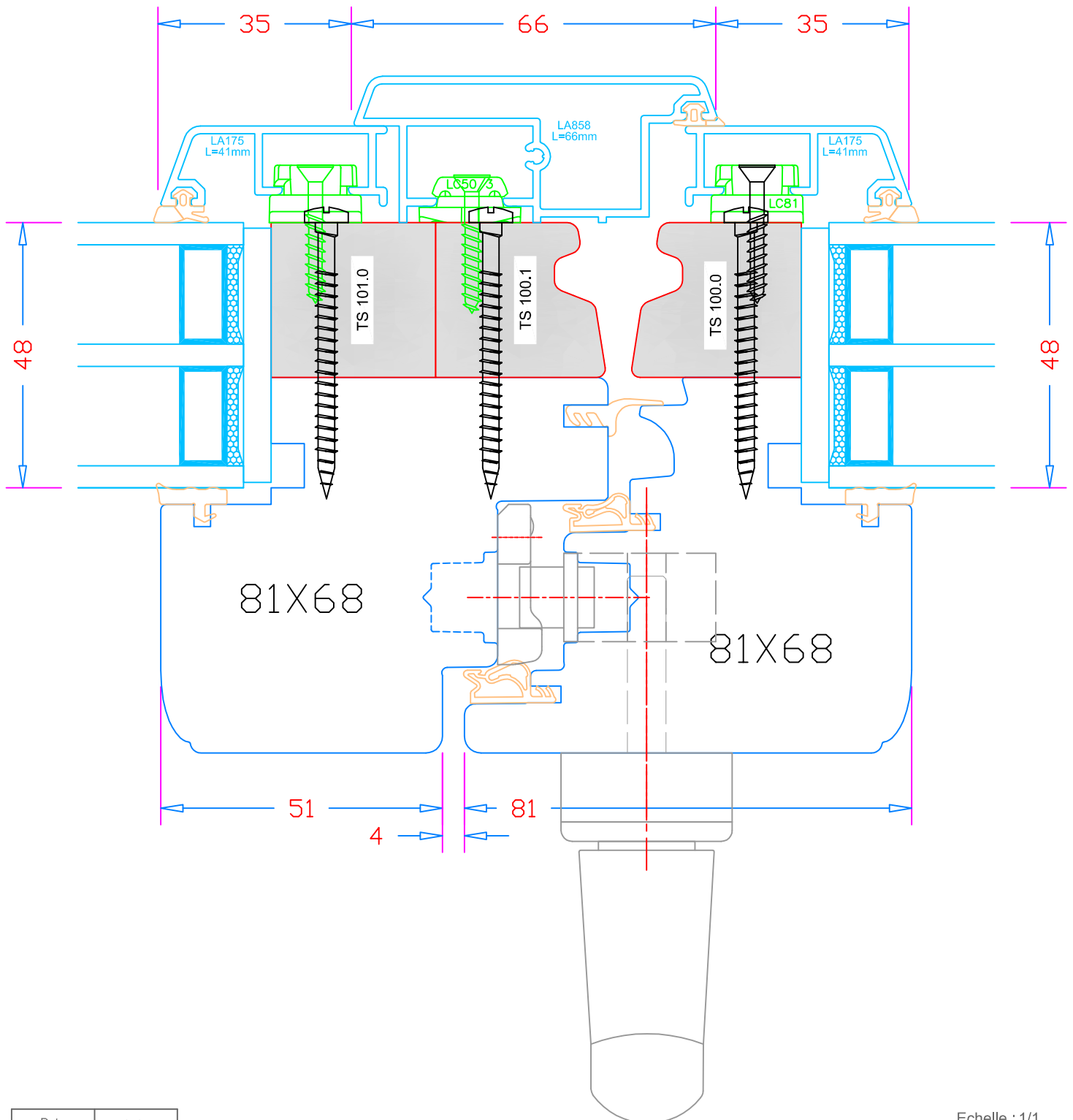
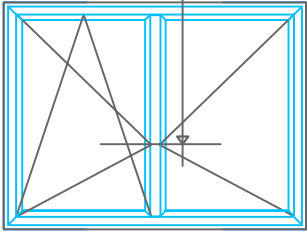

Coupe 48
 Vue intérieure

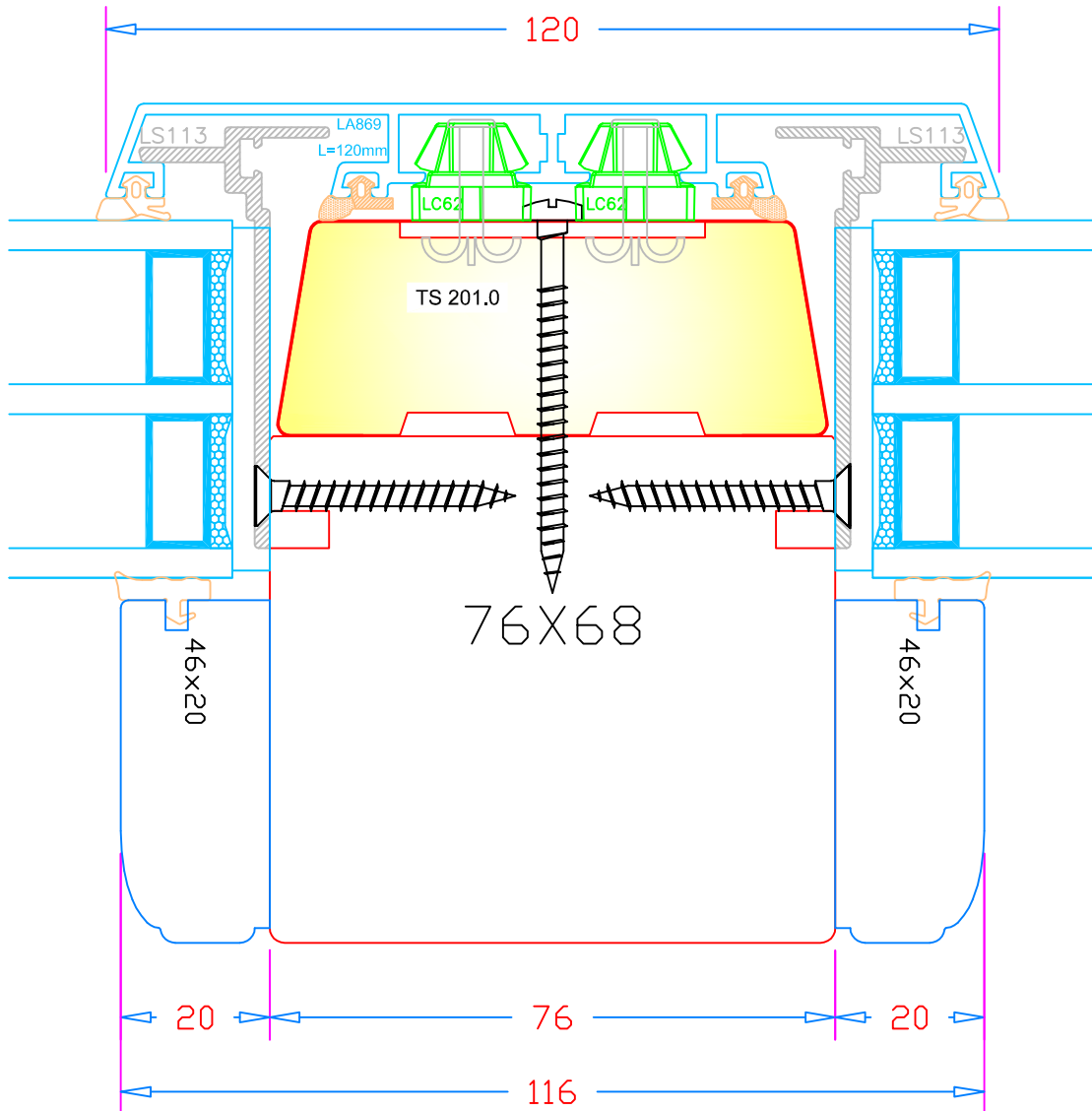
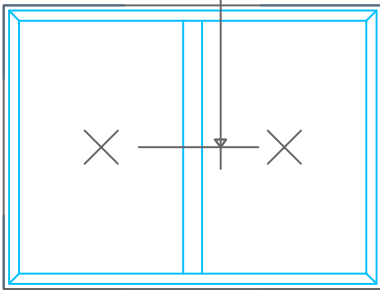

Coupe 49a
Vue intérieure

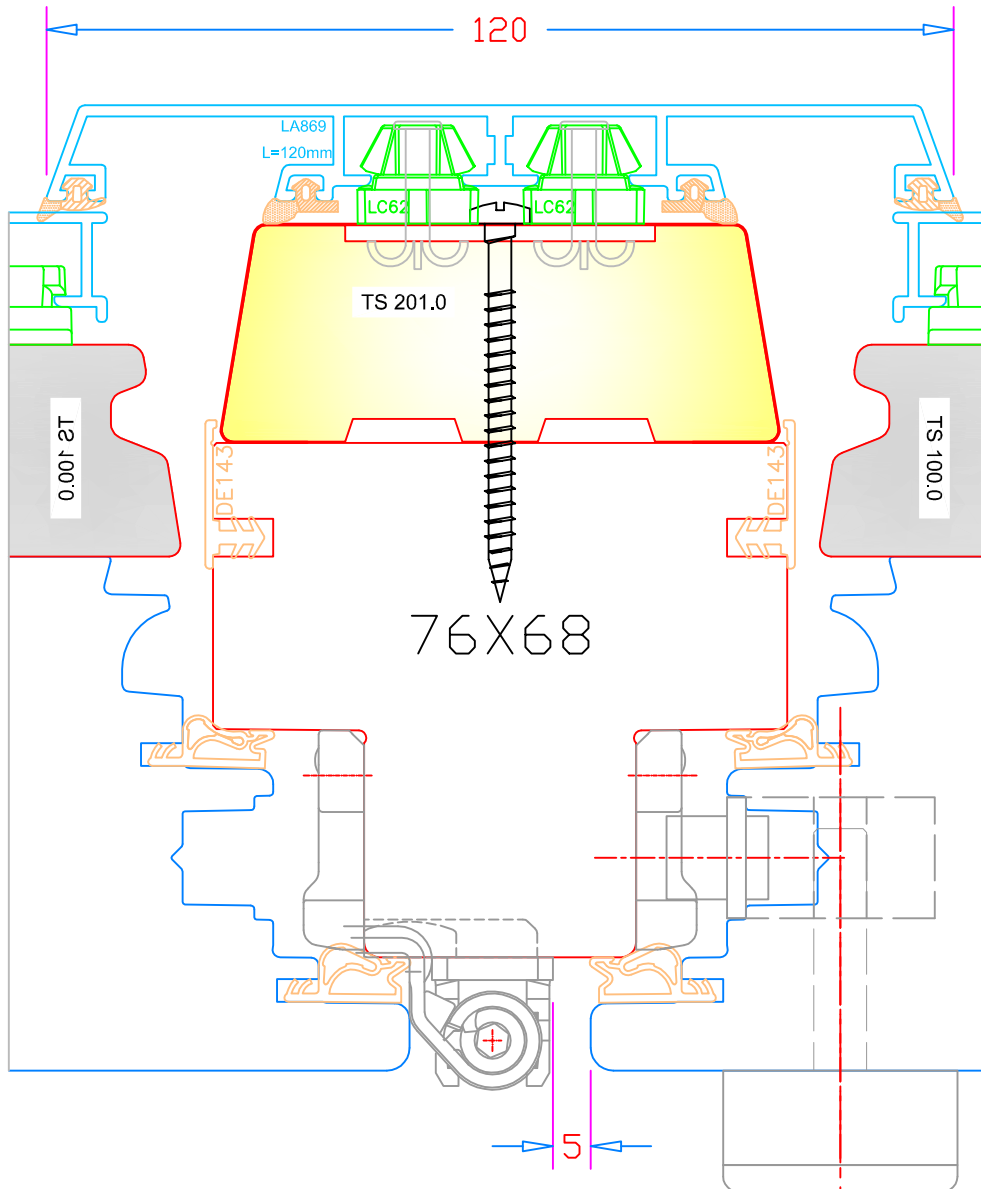
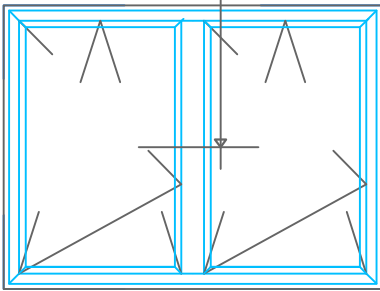

PALIER

Attention, meneau ouvrant + ouvrant, avec double palier impossible.

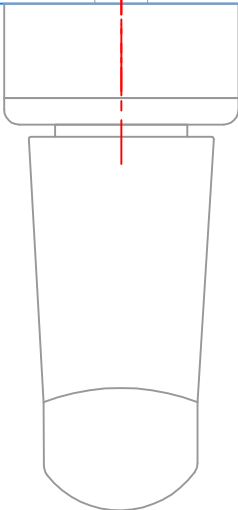

Coupe 49b
 Vue intérieure

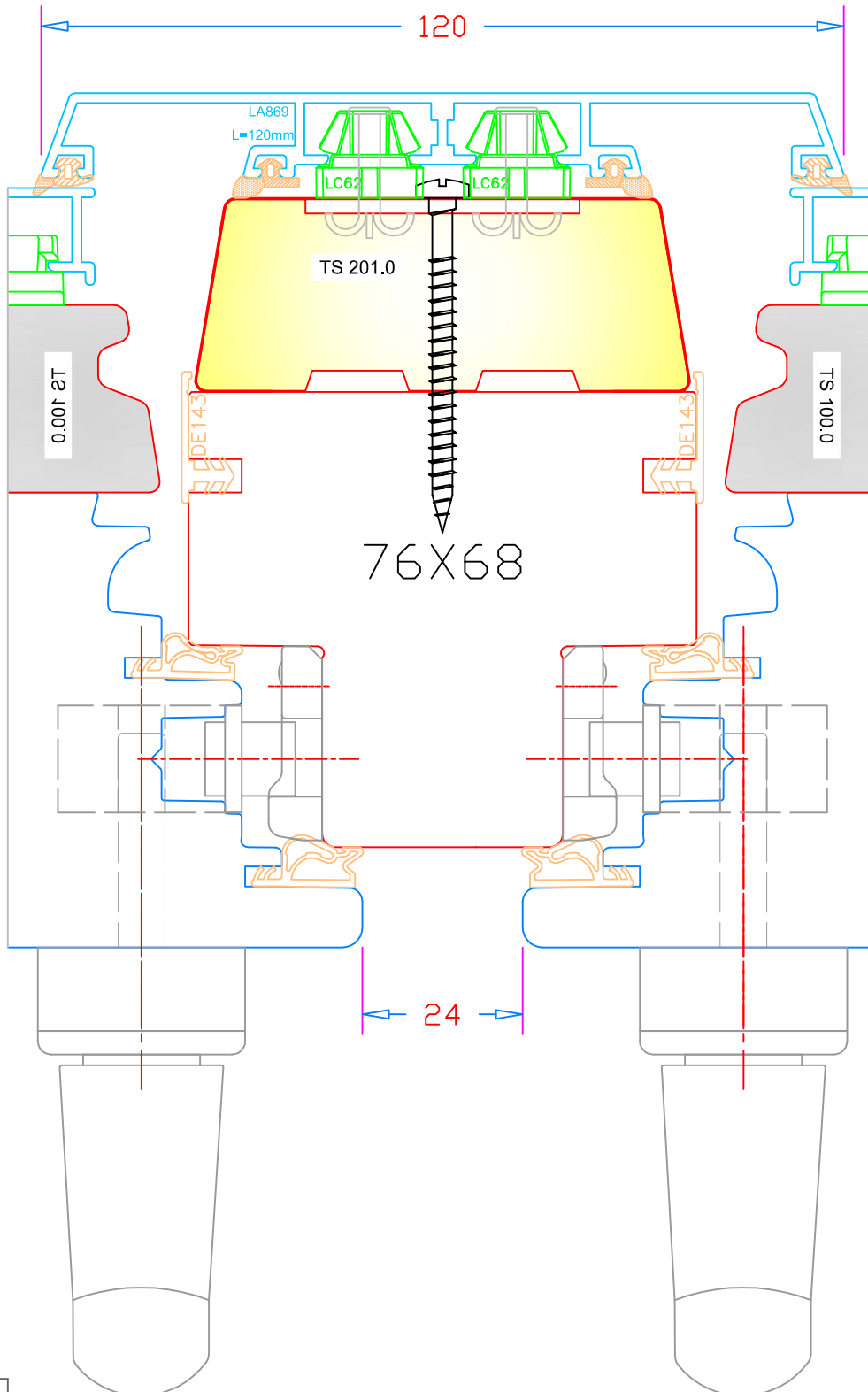
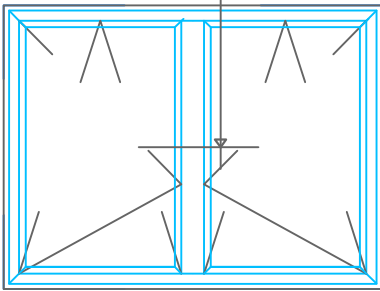

Coupe 50a
Vue intérieure

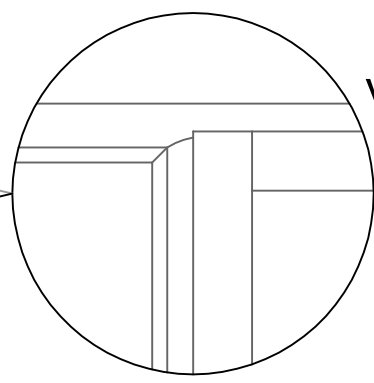
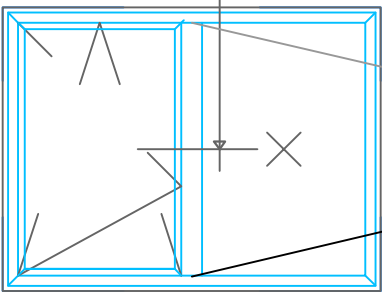

Vue intérieure
Assemblage du meneau

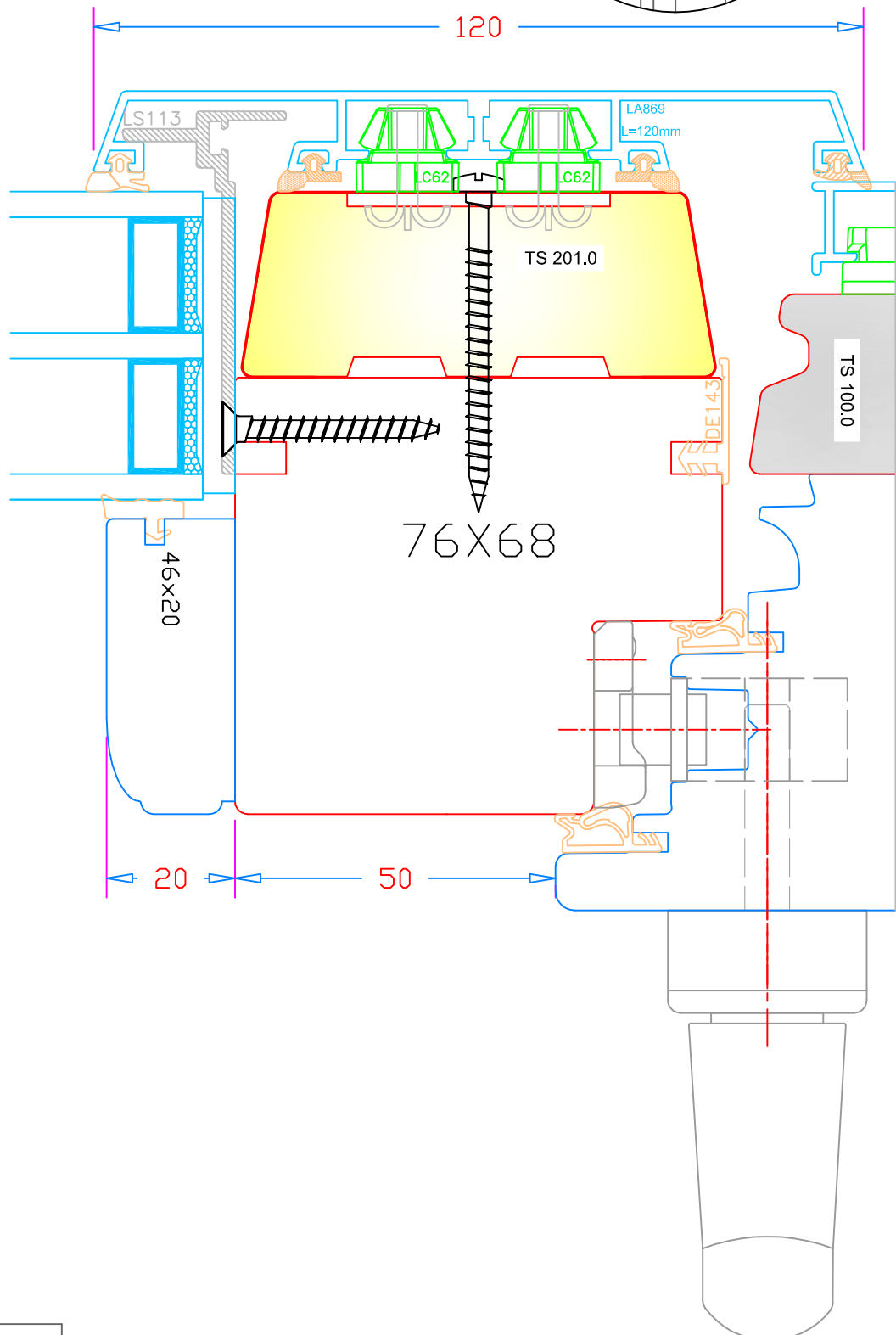

Coupe 50b
 Vue intérieure

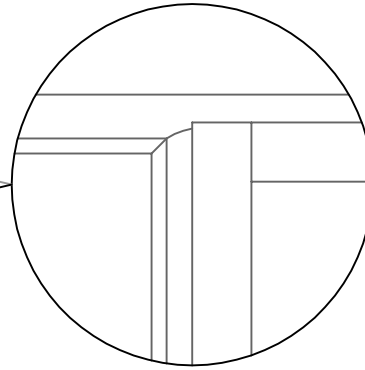
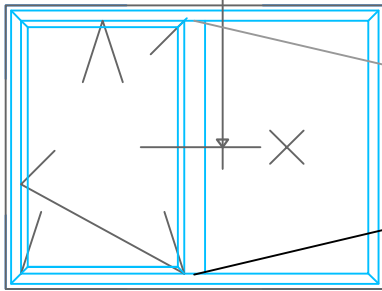

Vue intérieure
 Assemblage du meneau

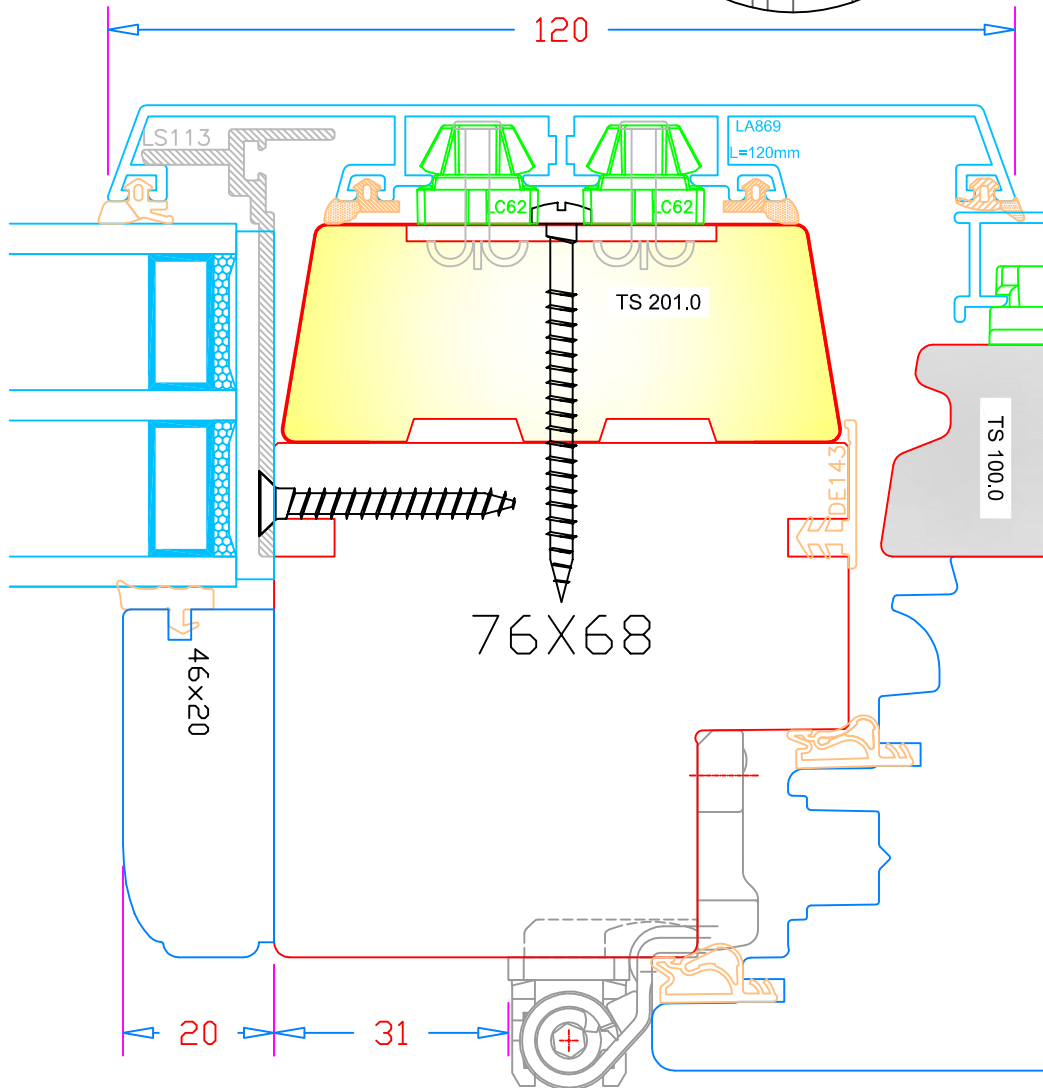

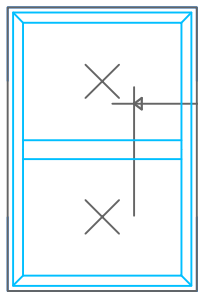

Coupe 51

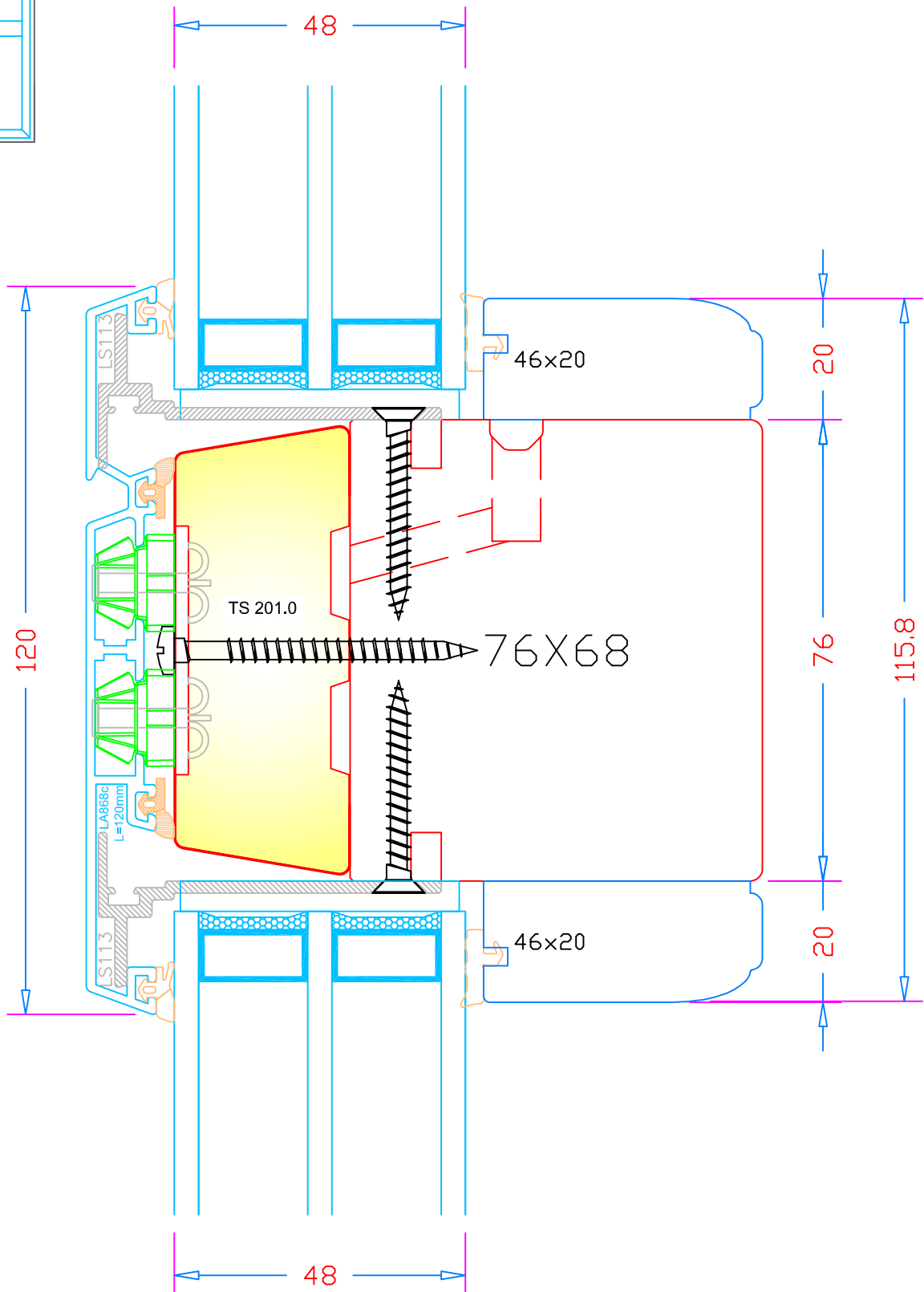

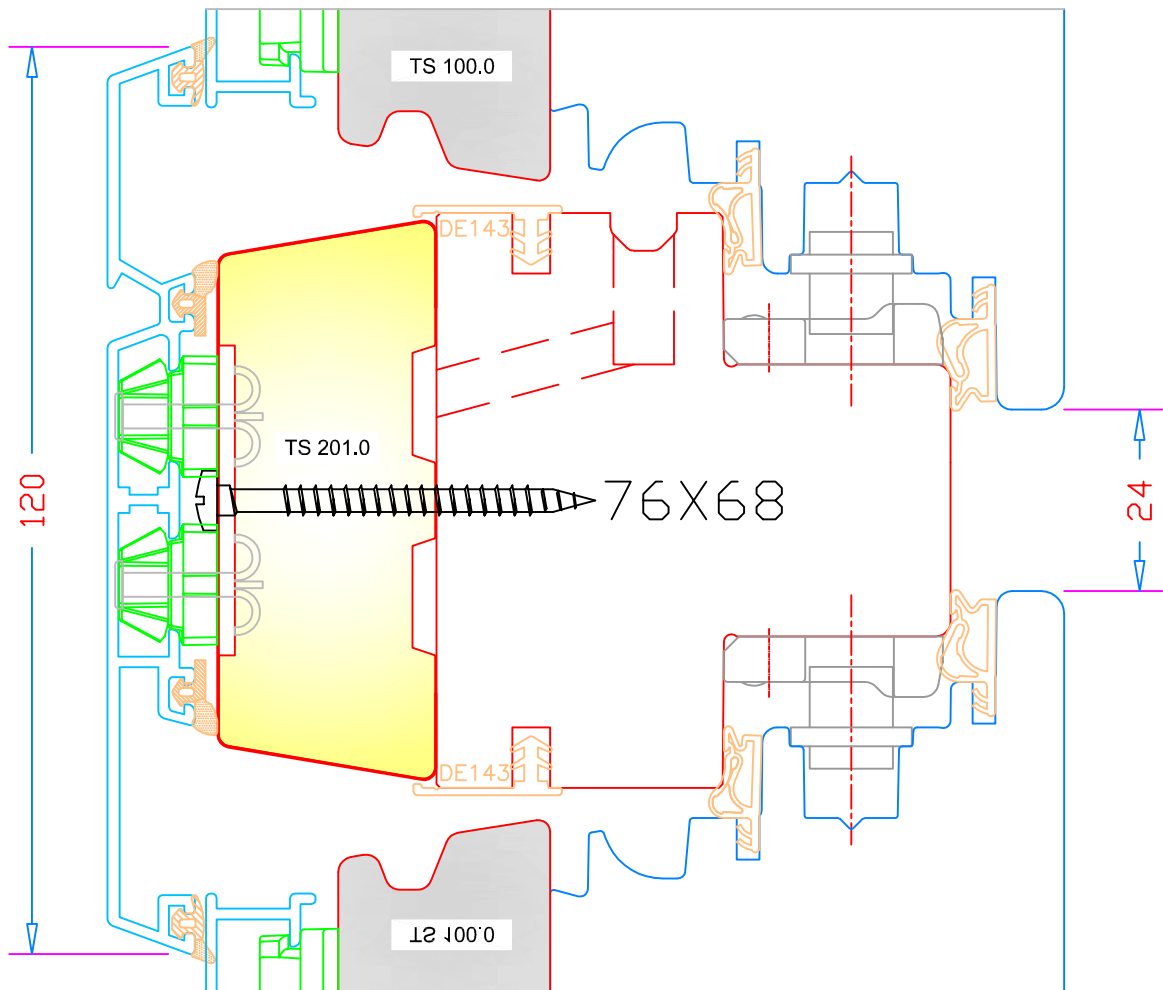
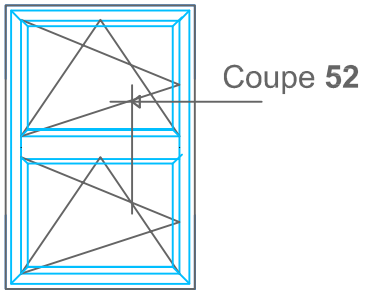

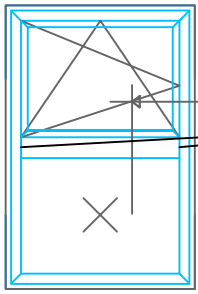

Coupe 53

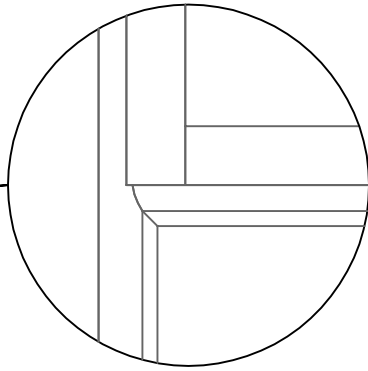

Vue intérieure

Assemblage de la traverse intermédiaire

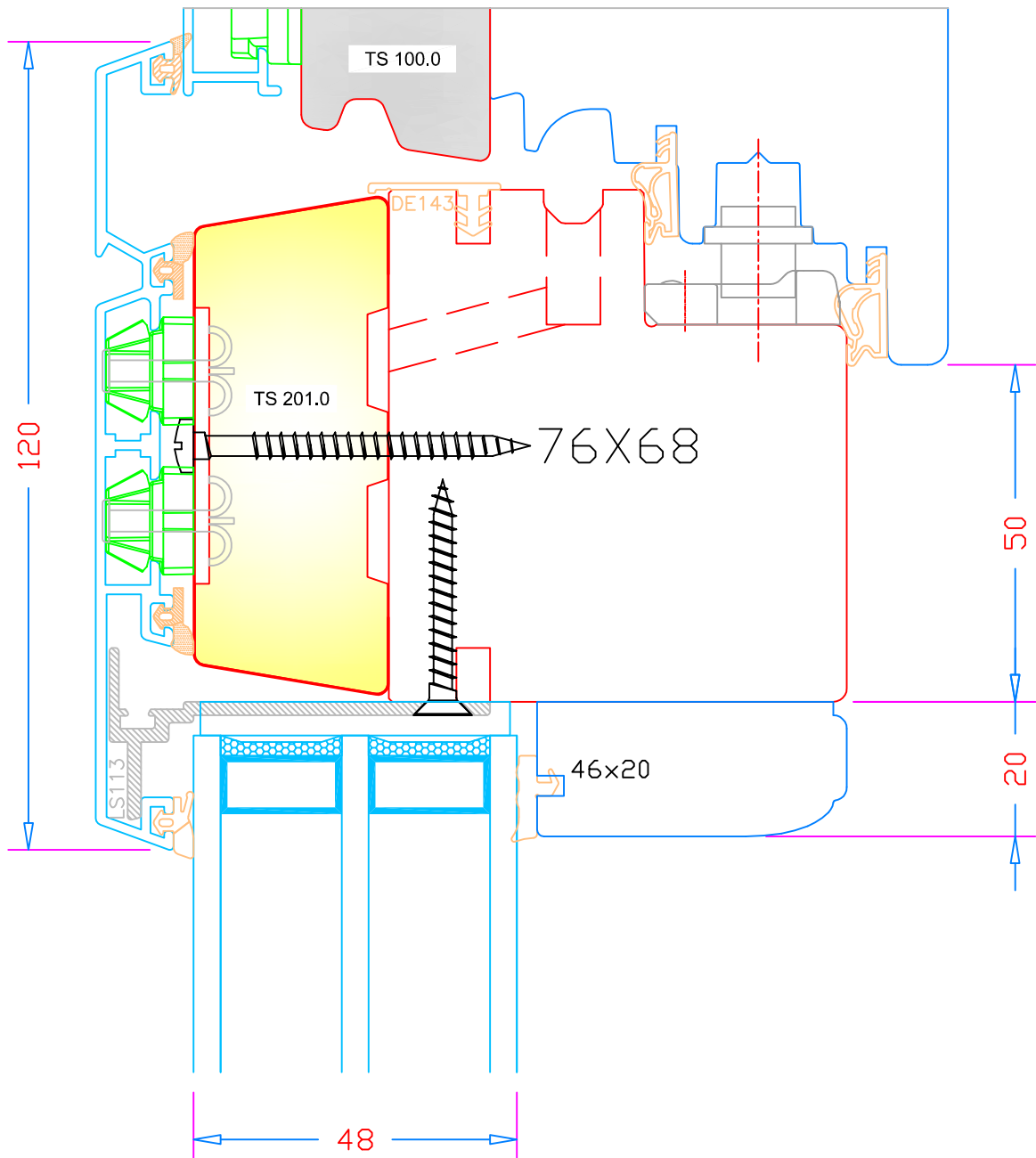

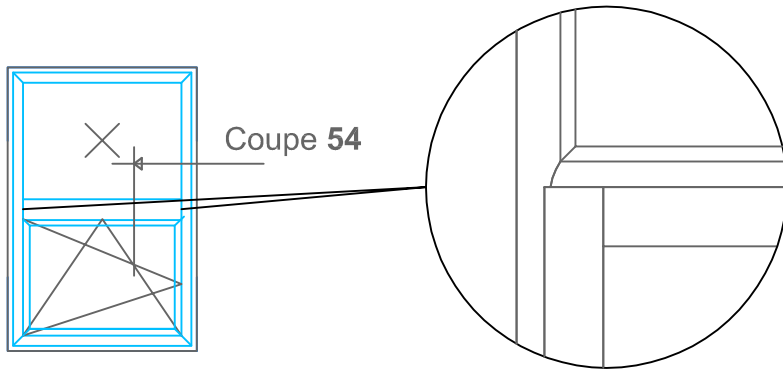

Vue intérieure
 Assemblage de la traverse intermédiaire

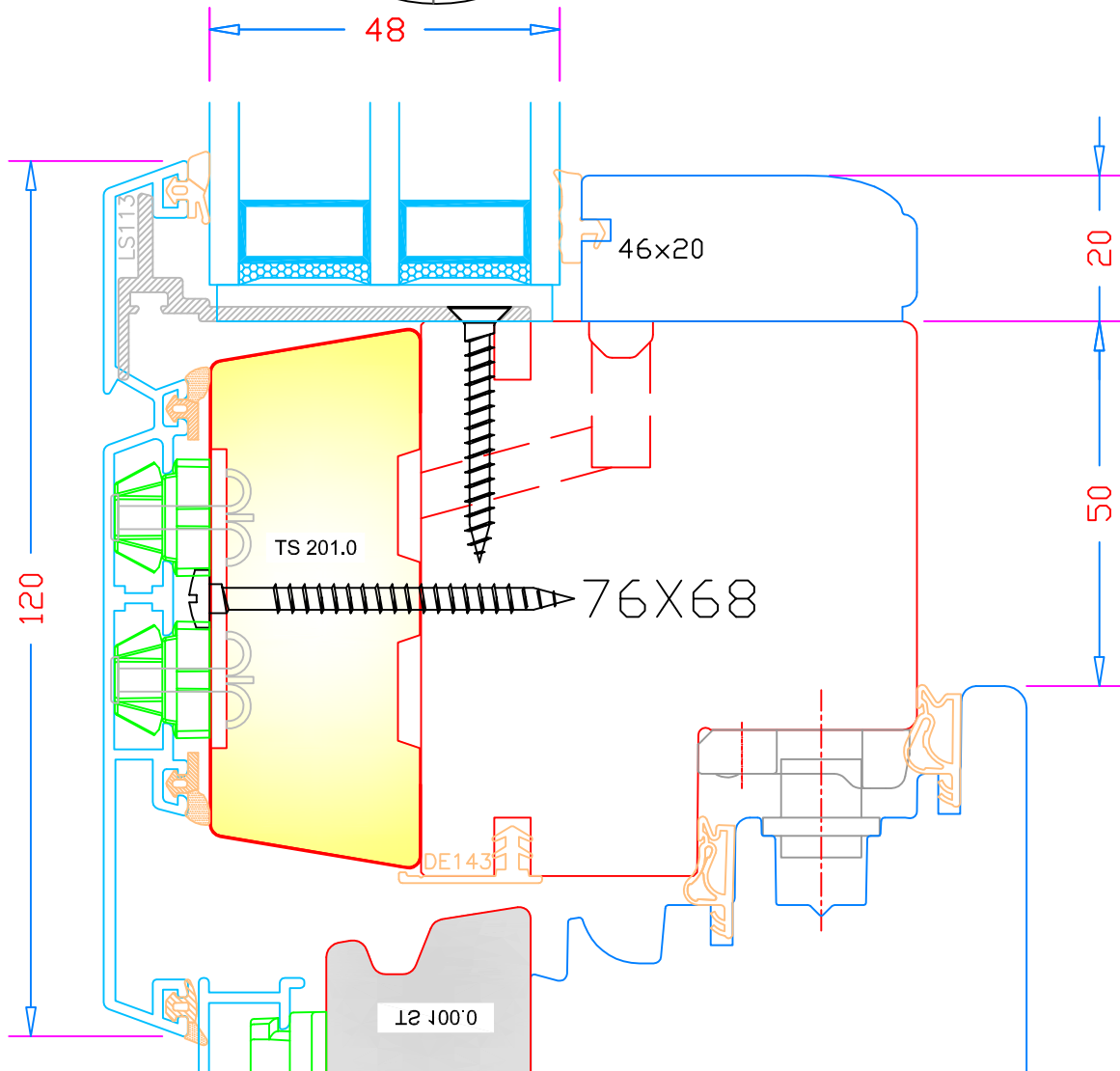

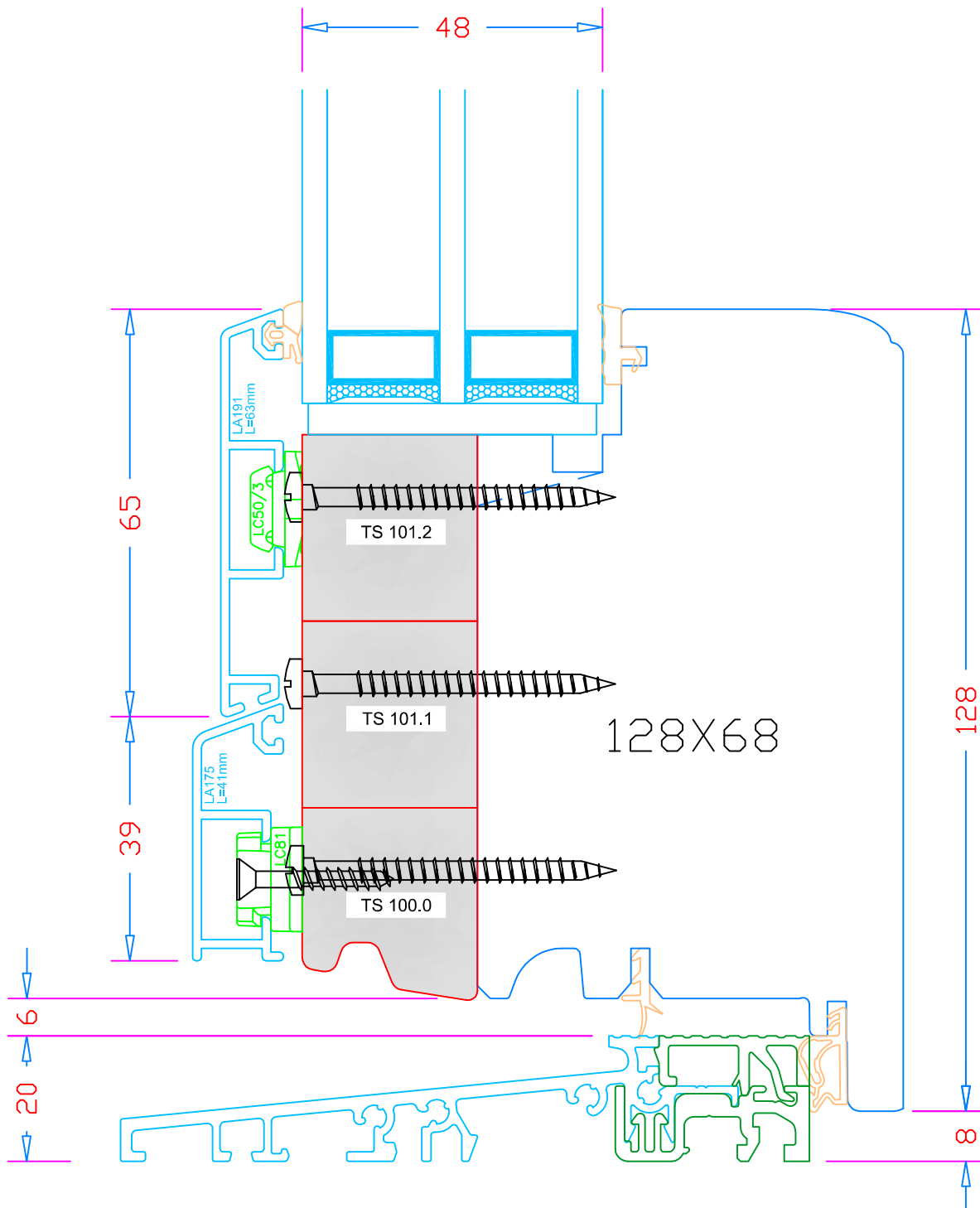
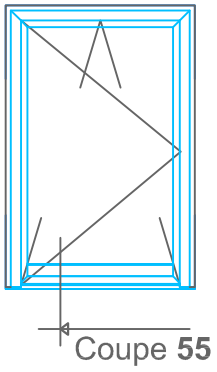

Mise en oeuvre de pose

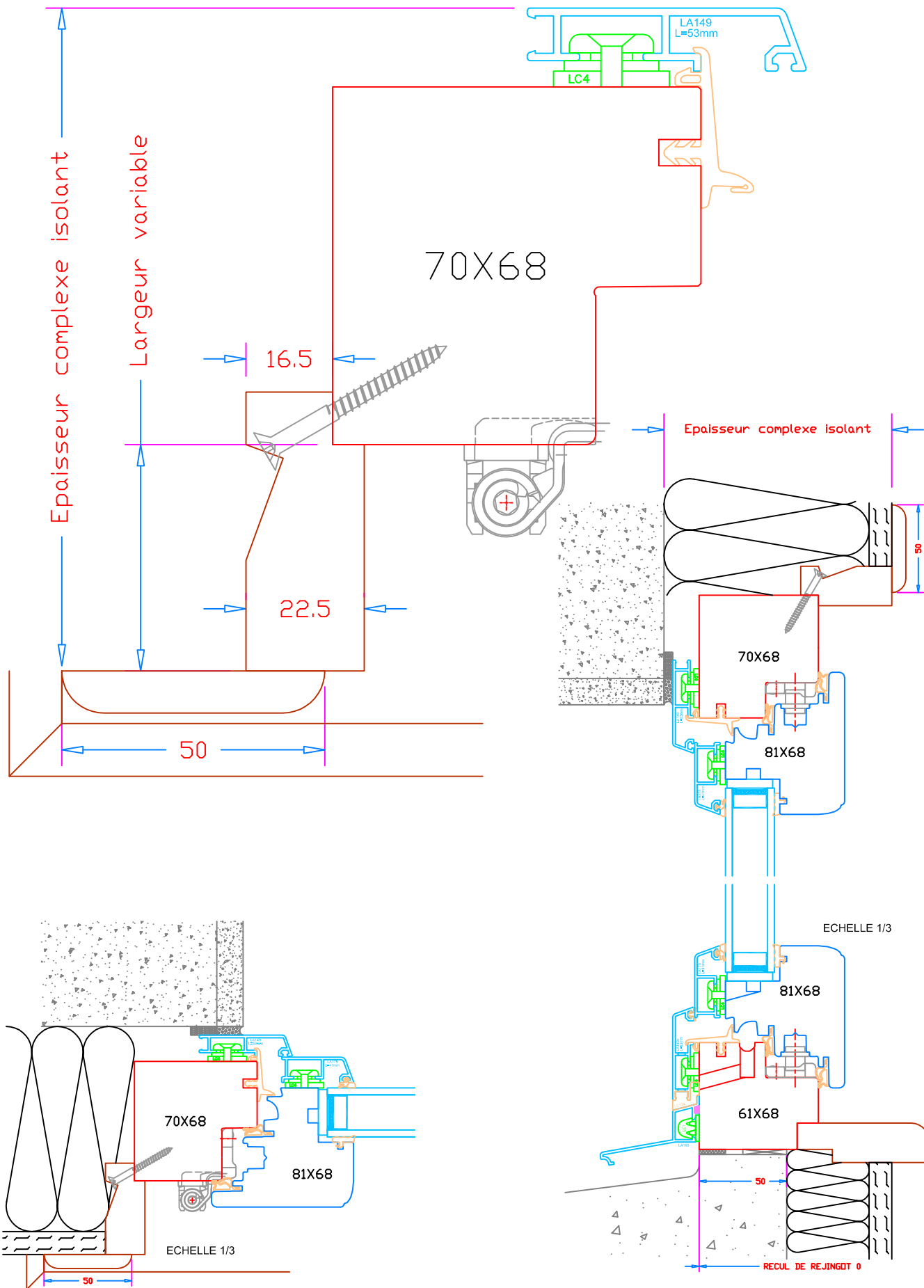

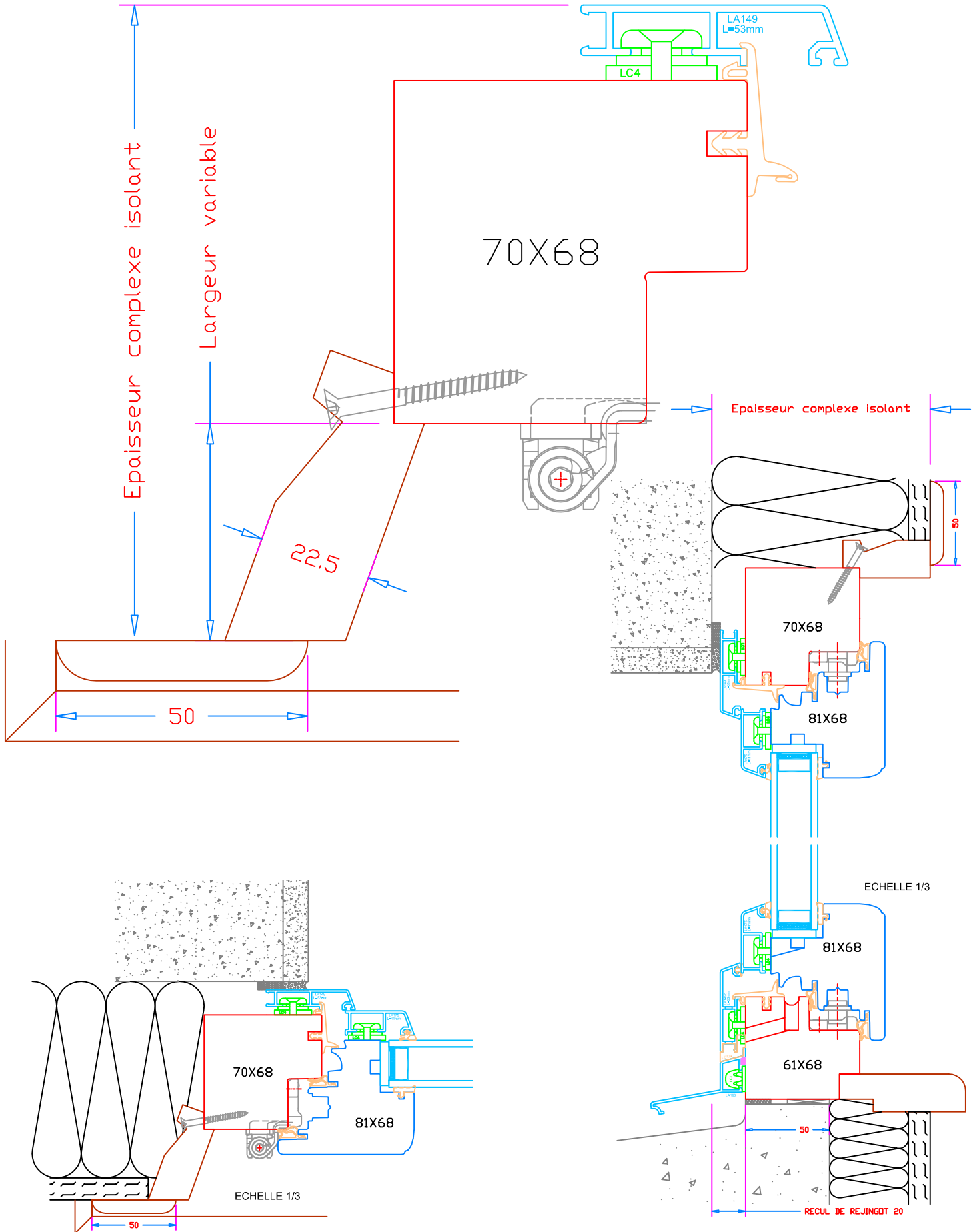

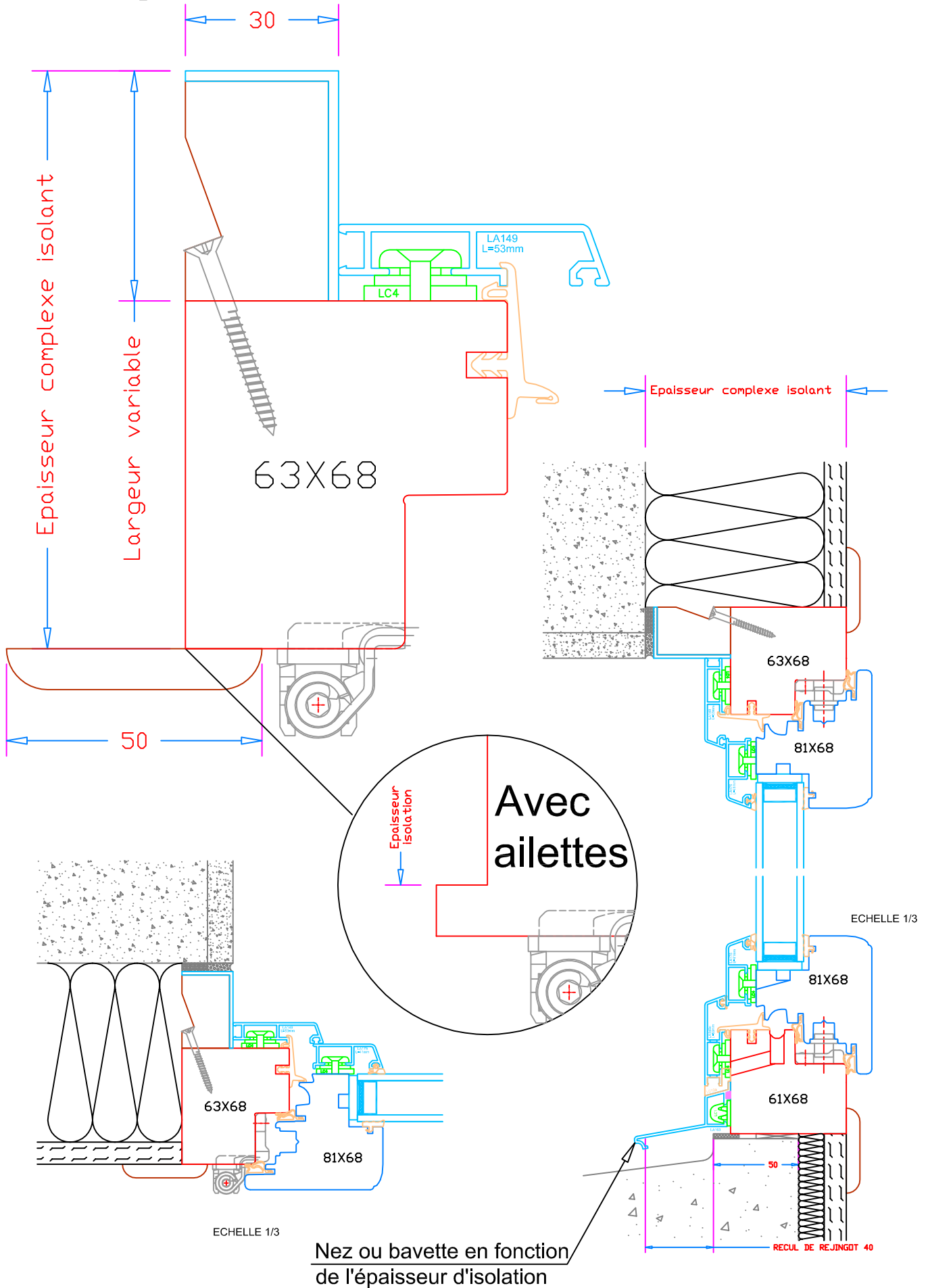

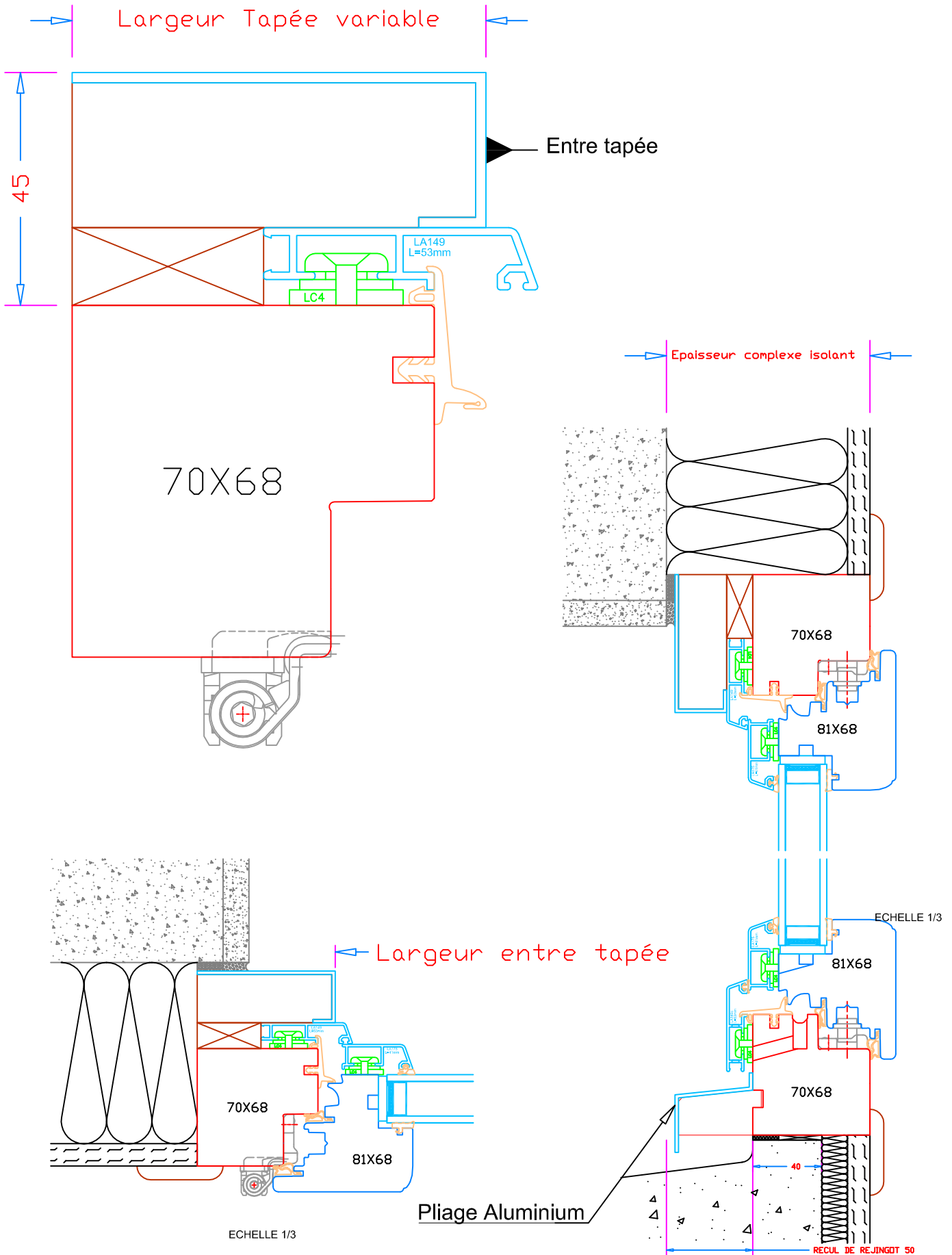

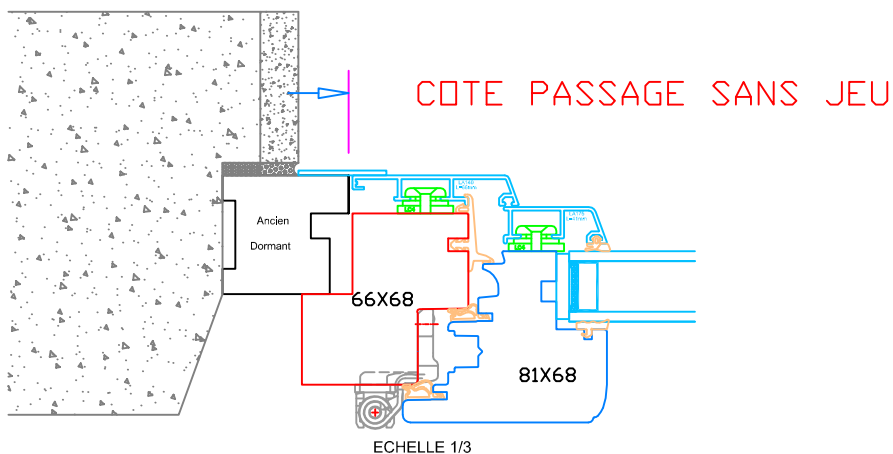
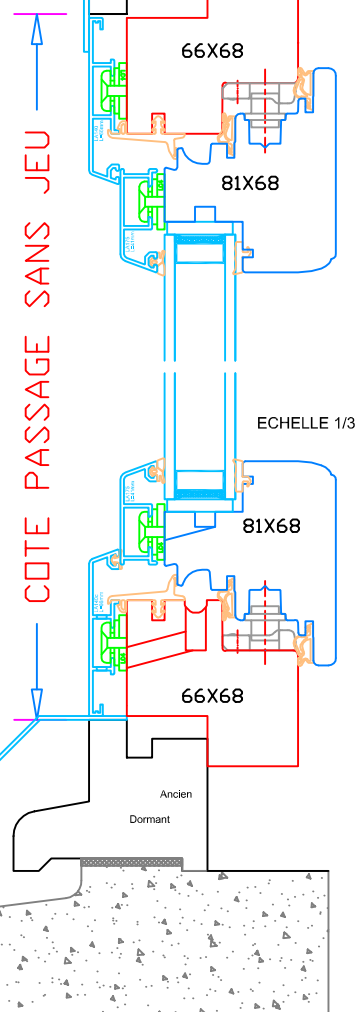
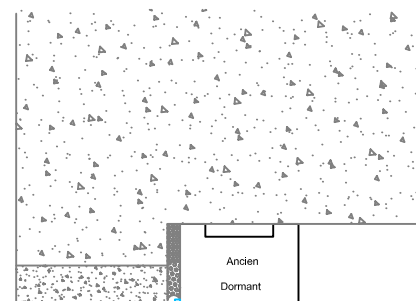
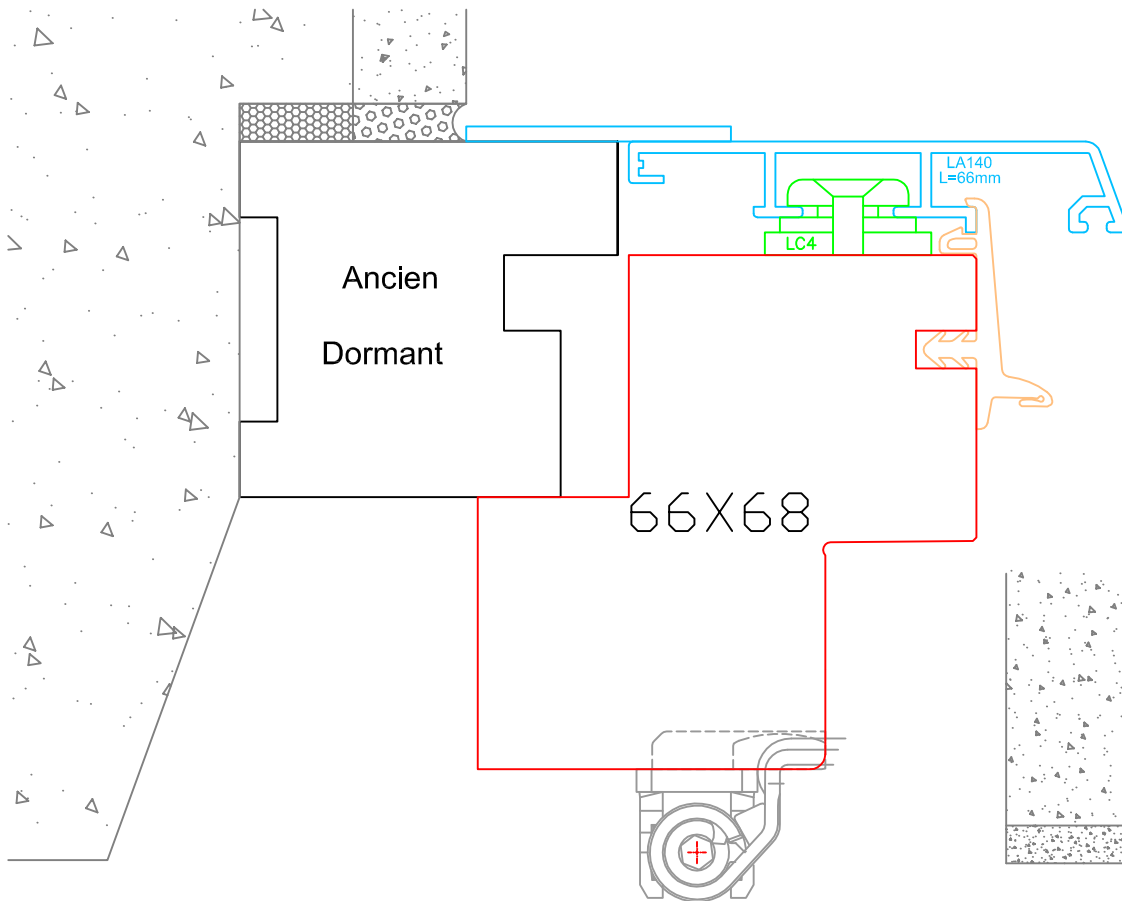

Cornière Aluminium

Echelle : 1/1

Date	10/10/2019
------	------------

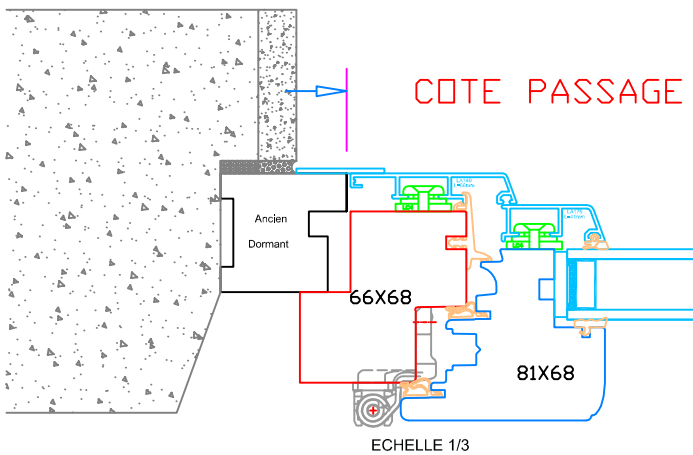
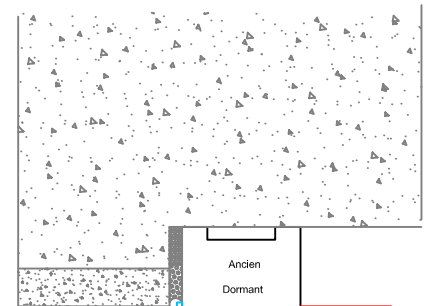
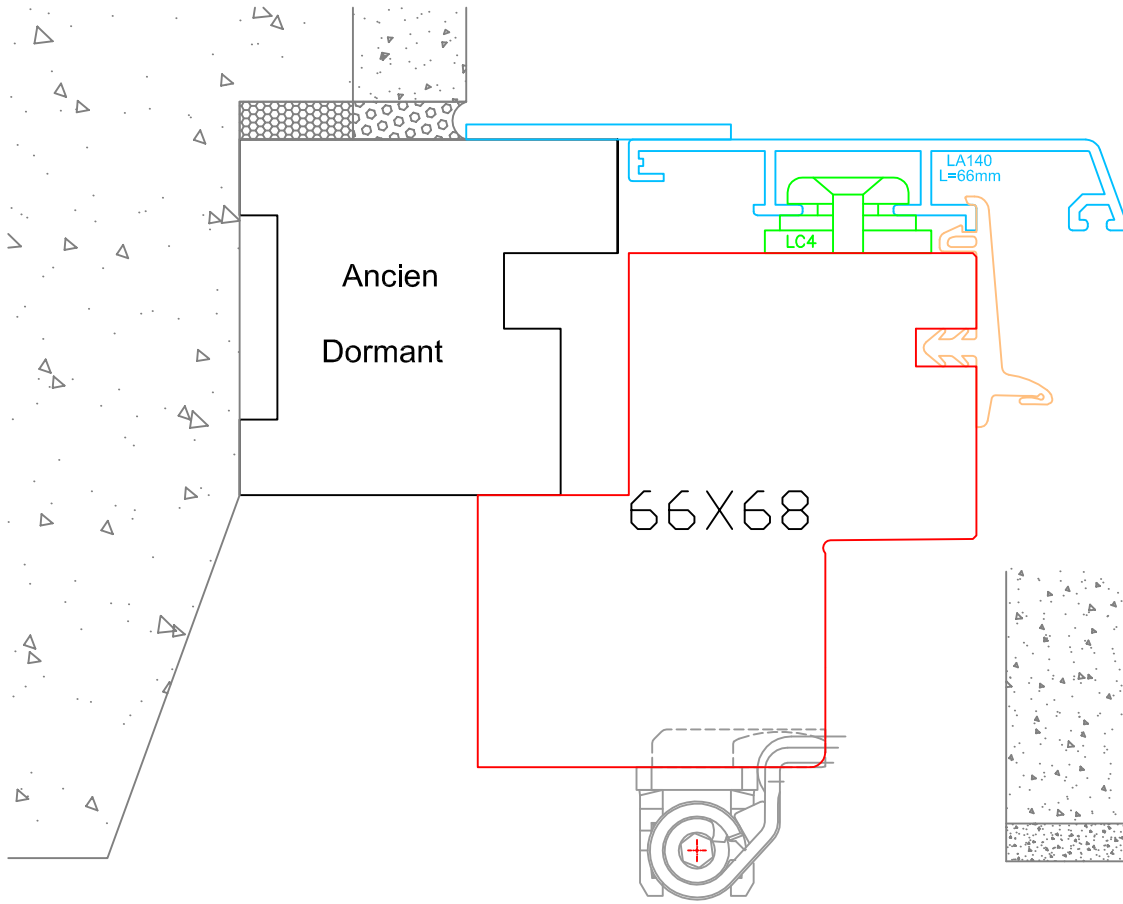

COTE PASSAGE SANS JEU

ECHELLE 1/3

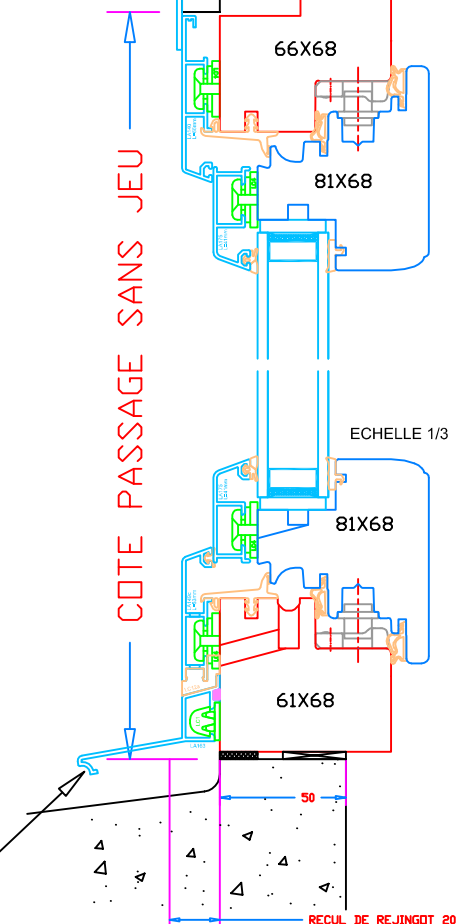

COTE PASSAGE SANS JEU

ECHELLE 1/3

81X68

61X68

50

RECU DE REJINGOT 20

Nez en fourniture

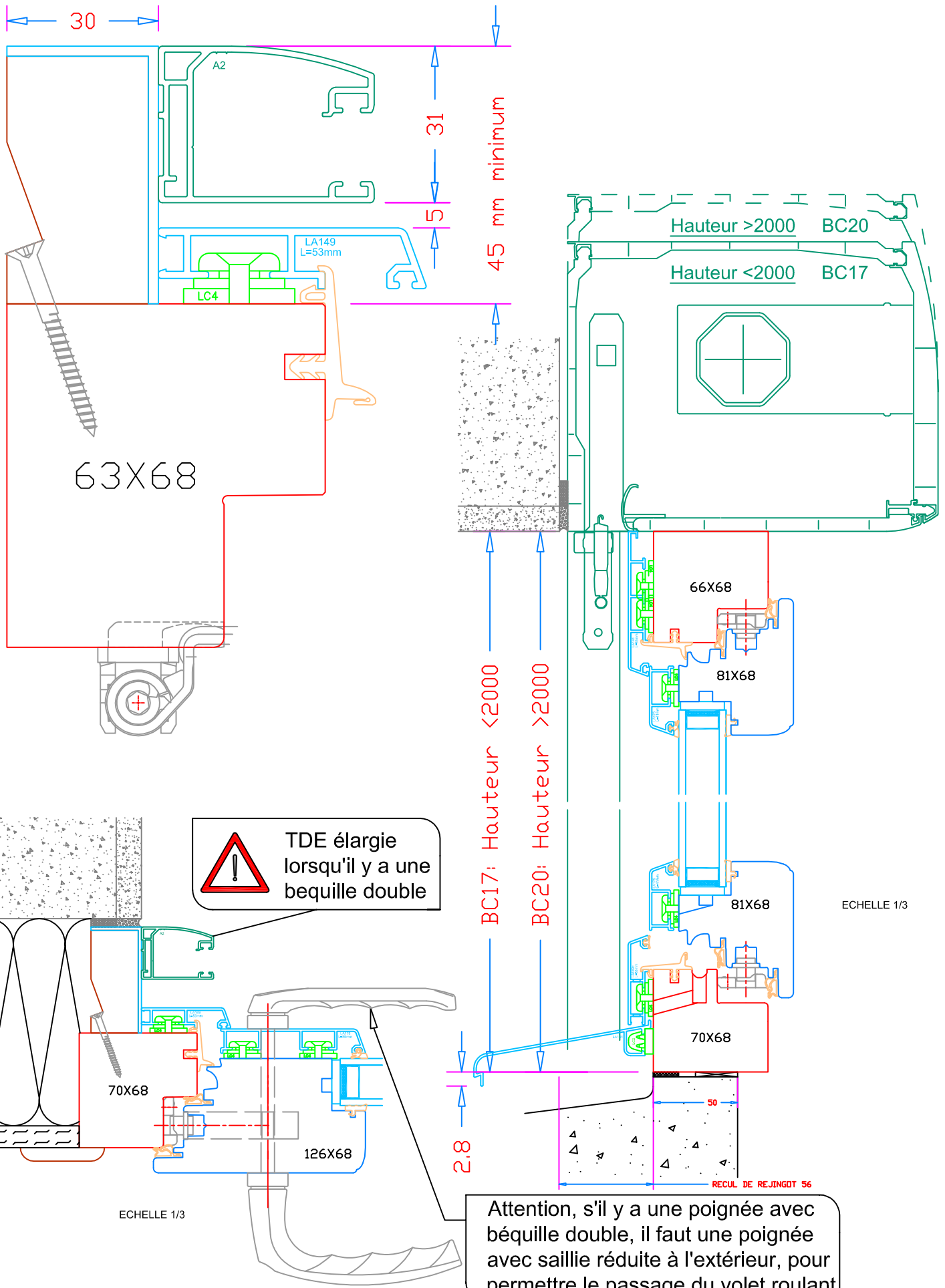

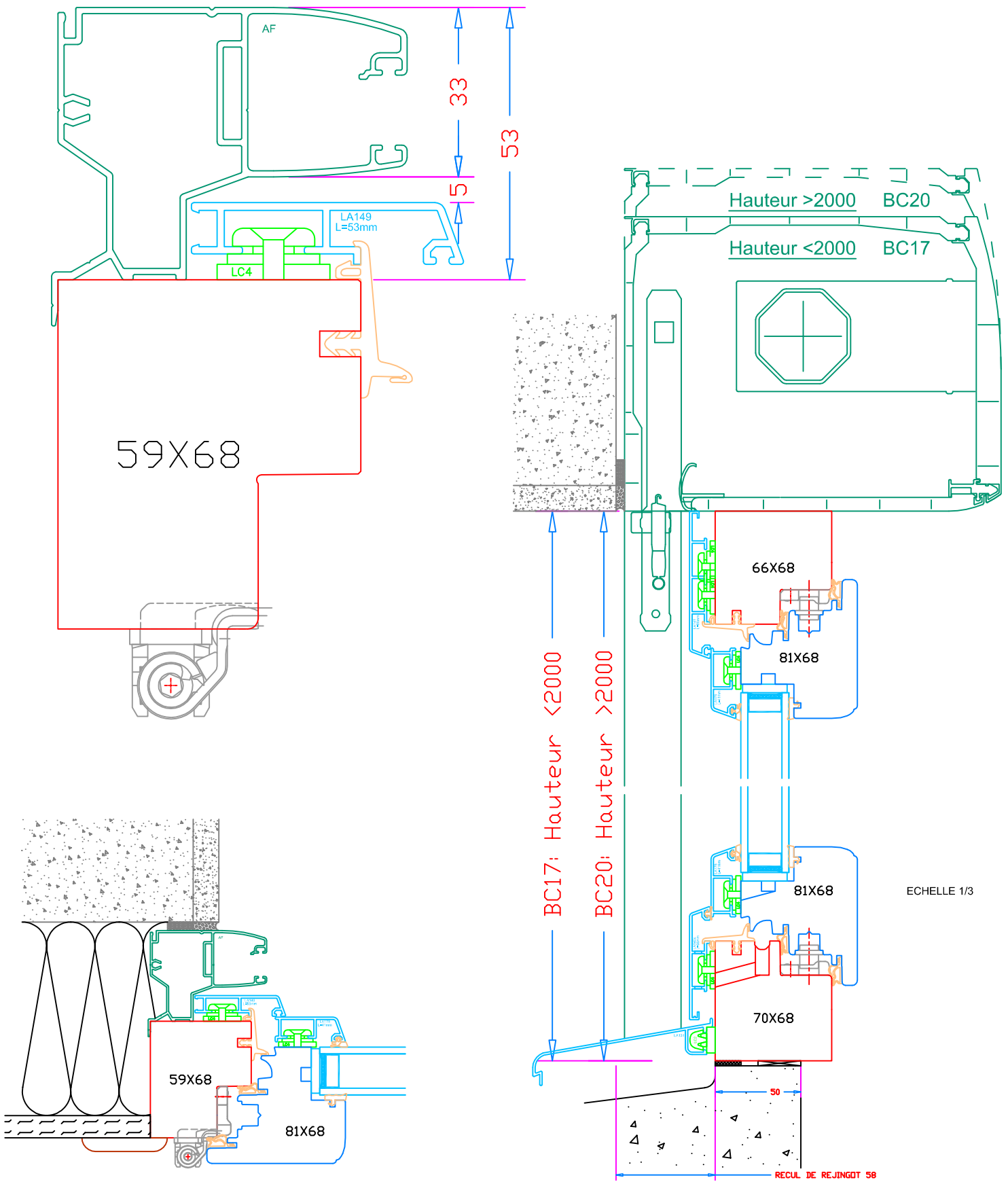

ECHELLE 1/3

ECHELLE 1/3



Avec une béquille double, il faut utiliser la coulisse aluminium A2

Date 10/10/2019

Echelle : 1/1

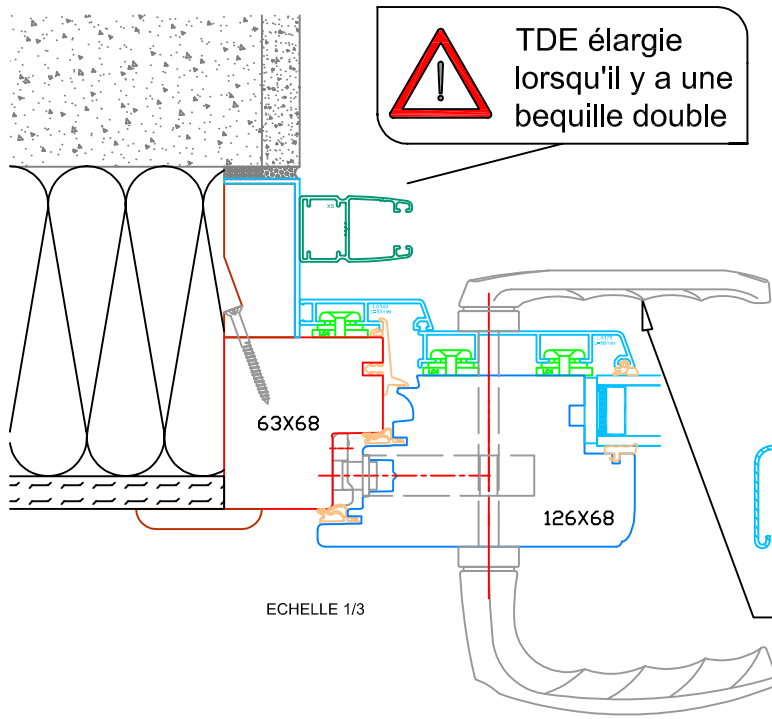
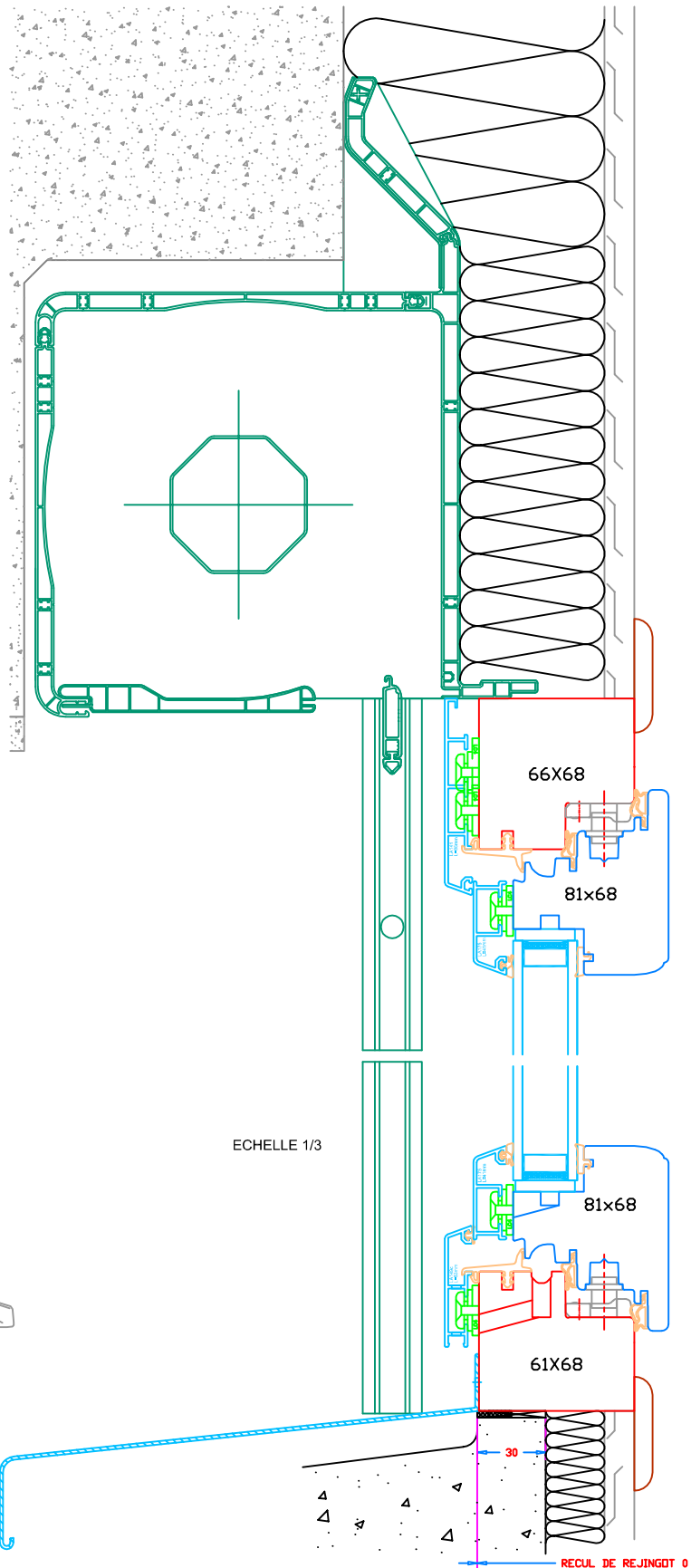
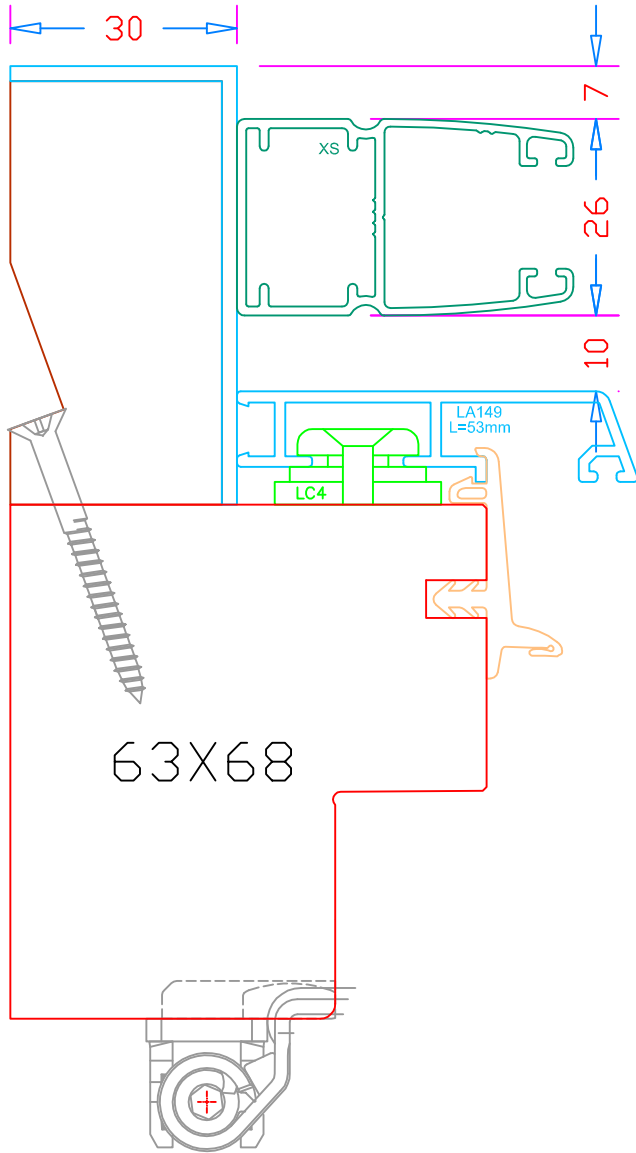

Attention, s'il y a une poignée avec béquille double, il faut une poignée avec saillie réduite à l'extérieur, pour permettre le passage du volet roulant.

Date	10/10/2019
------	------------

Echelle : 1/1

