

UNI 9

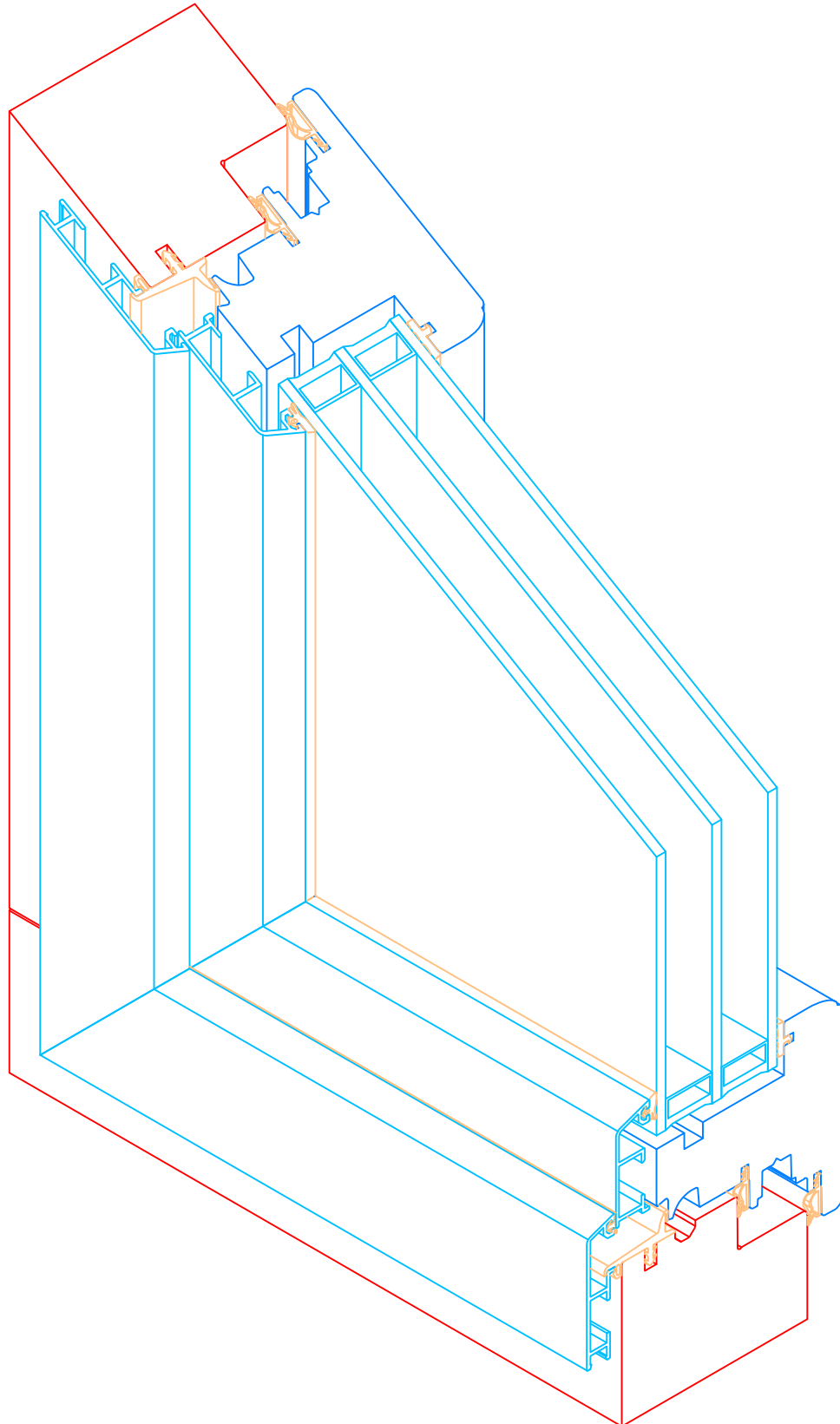















Date	17/10/2014
------	------------







Détails divers	
Typologies de menuiseries	D 01
Profils ouvrants	D 02
Composition des vitrages	D 03
Parclofes	D 04
Petits bois collés	D 05
Poignées	D 06
Dimension cylindre	D 07
Anti-panique	D 08 à D 09
Paumelles	D 10 à D11

Coupes	
Standard	
Vitrage en dormant	C 01 à C 03
Ouvrant	C 04 à C 10
Pièce intermédiaire ouvrant	C 11 à C 12
Meneau	C 13 à C 15
Traverse intermédiaire dormant	C 16 à C 19
Seuil porte-fenêtre	C 20 à C 21
Soubassement de porte-fenêtre	C 22 à C 24
Panneau de soubassement	C 25 à C 28
Coulissant basculant	C 29 à C 33
Ouverture Extérieure	
Ouvrant	C 34 à C 37

Mise en oeuvre de pose	
Tapée de doublage intérieure	P 01 à P 02
Tapée de doublage extérieure	P 03
Tapée persienne	P 04
Rénovation	P 05 à P 06
Volet roulant bloc N	P 07 à P 08
Volet roulant bloc Y	P 09 à P 10
Brise soleil orientable	P 11

Détails divers

	Vitrage en dormant
	Ouvrant un vantail
	Ouvrant deux vantaux
	Ouvrant avec petit bois massif vertical
	Ouvrant avec petit bois massif horizontal
	Vitrage en dormant double avec meneau
	Ouvrant double avec meneau
	Ouvrant avec partie latérale fixe
	Vitrage en dormant double avec traverse intermédiaire
	Ouvrant double avec traverse intermédiaire
	Ouvrant avec allège fixe
	Ouvrant avec imposte fixe
	Porte-fenêtre avec seuil PMR
	Porte-fenêtre avec appui bois

	Porte fenêtre avec seuil PMR et traverses empilées
	Porte-fenêtre avec appui bois et traverses empilées
	Porte-fenêtre avec seuil PMR et panneau de soubassement
	Porte-fenêtre avec appui bois et panneau de soubassement
	Coulissant basculant
	Ouverture extérieure un vantail
	Ouverture extérieure deux vantaux

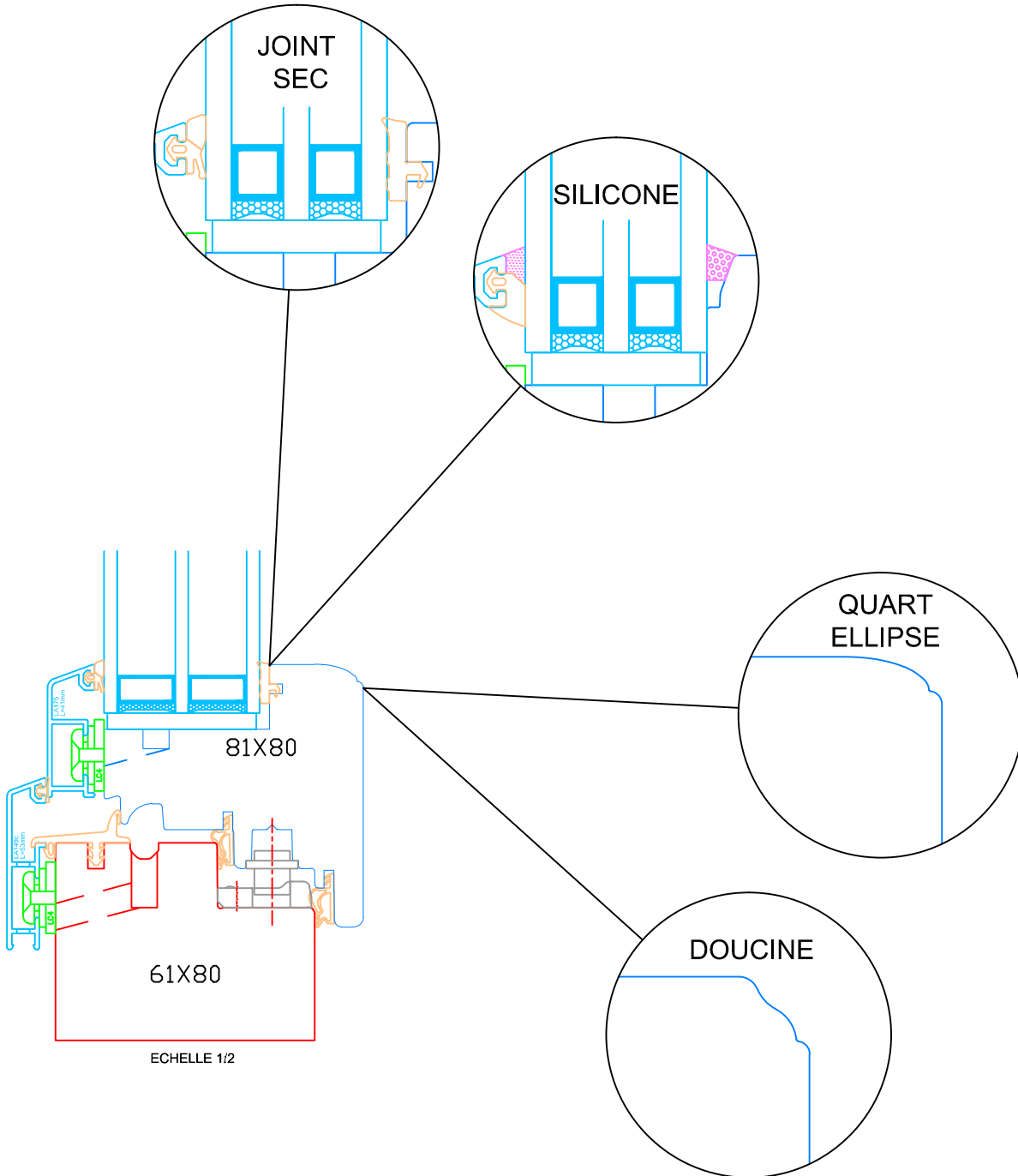

Triple vitrage

Standard:

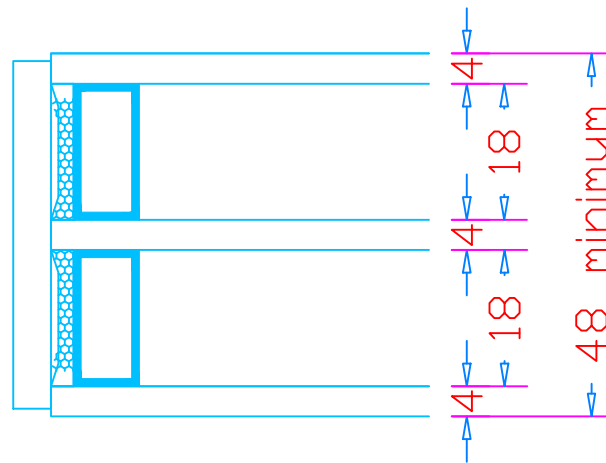

Avec joint sec:

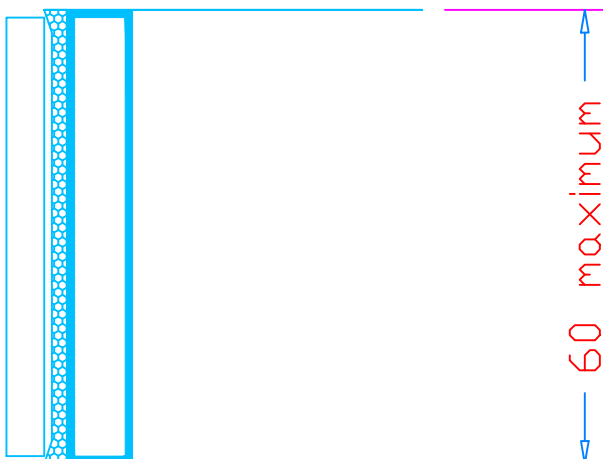

Avec silicone:

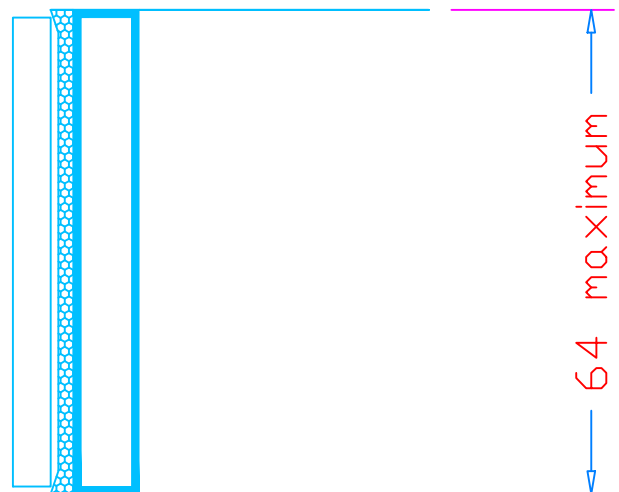

La gamme UNI 9 peut accueillir des vitrage allant de 48 à 60 mm (jusqu'à 64 mm en version silicone).



En standard, la composition du triple vitrage est 4/18/4/18/4.

Il est possible d'intégrer des vitrages feuilleté 44² ou 66².

La largeur minimale d'intercalaire est de 10mm.

Parcloze 29 mm (Pour vitrage de 48mm)

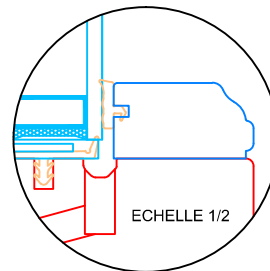
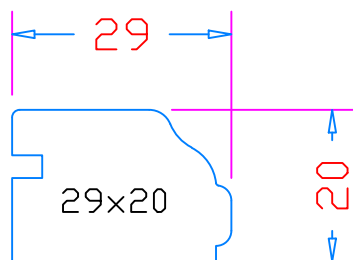
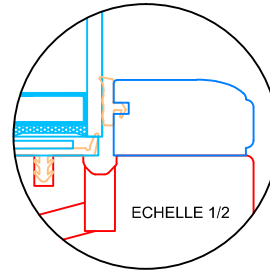
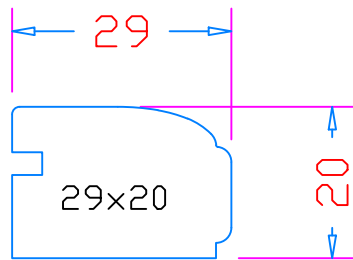

Parcloze 17 mm (Pour vitrage de 60 mm)

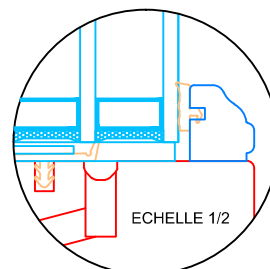
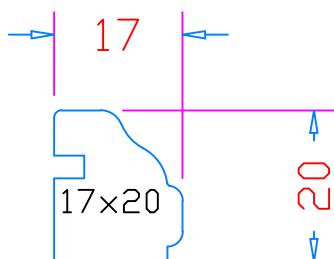
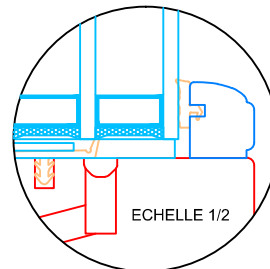
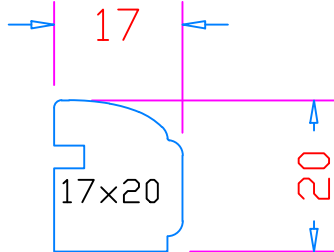

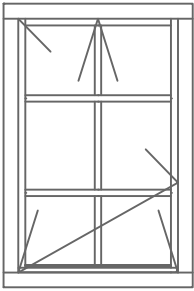

Quart ellipse



Il n'existe pas de petit bois collé avec un profil quart ellipse. Il faut associer le profil de l'ouvrant quart ellipse avec un petit bois collé profil pente.

PENTE

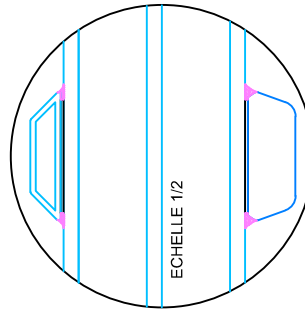
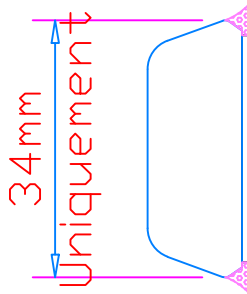

DOUCINE

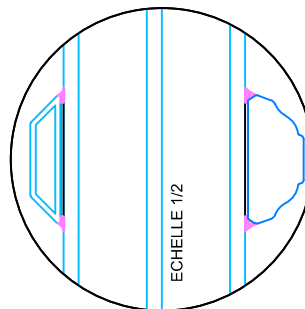
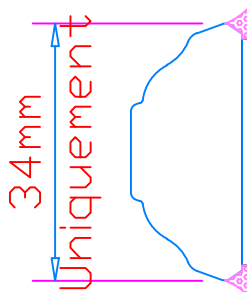

HOPPE ATLANTA

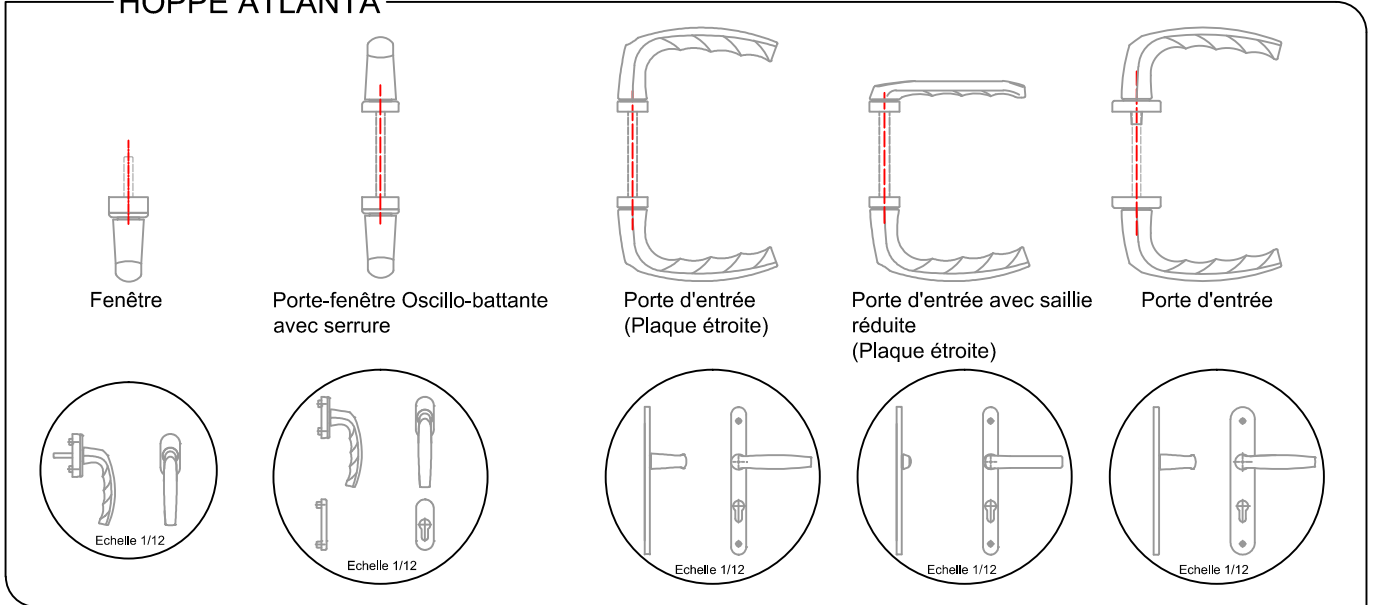

BRIONNE ENTRAYGUES

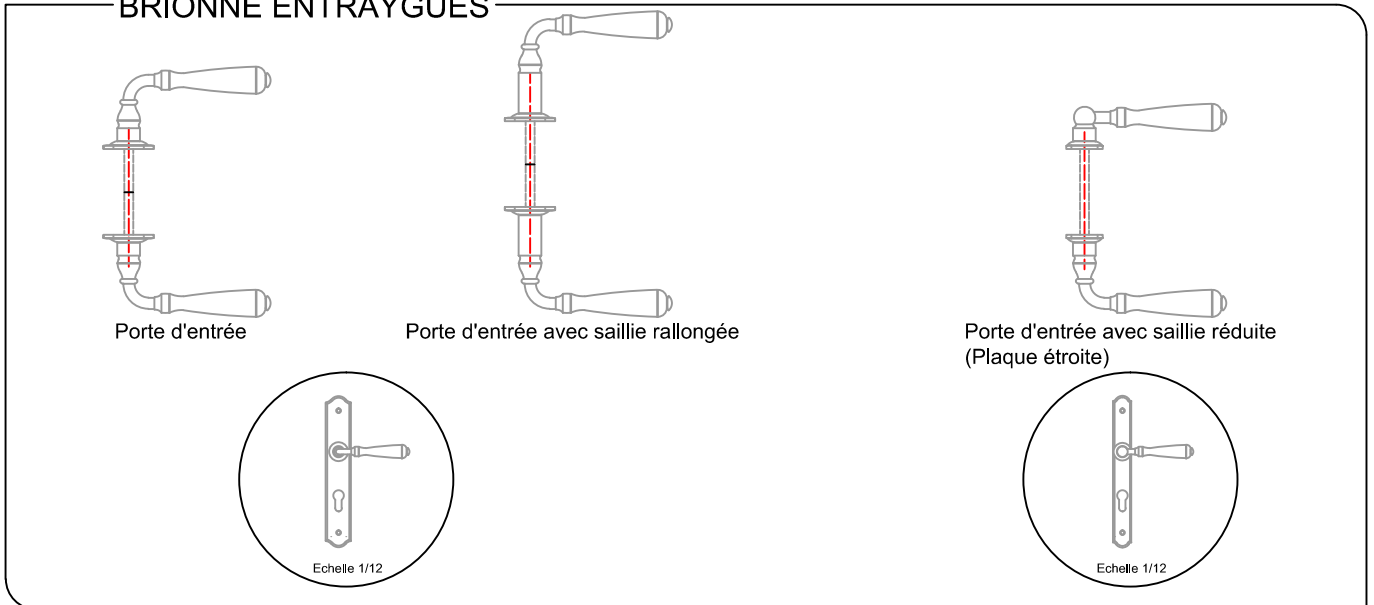

NORMBAU

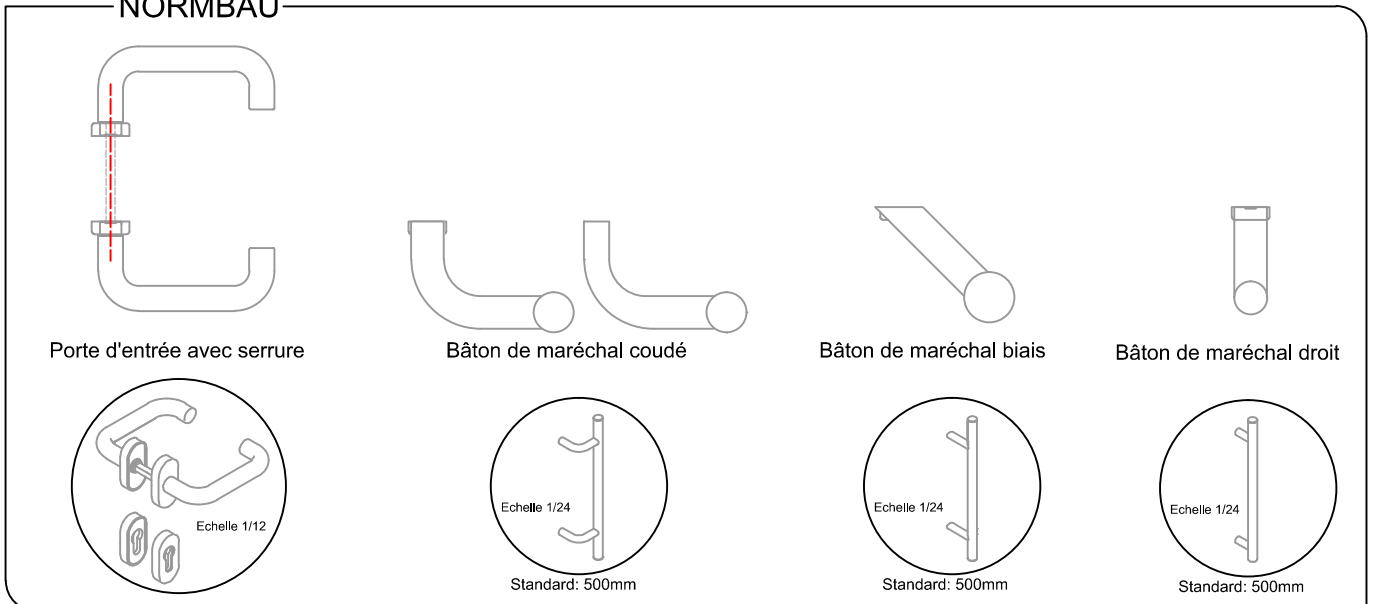

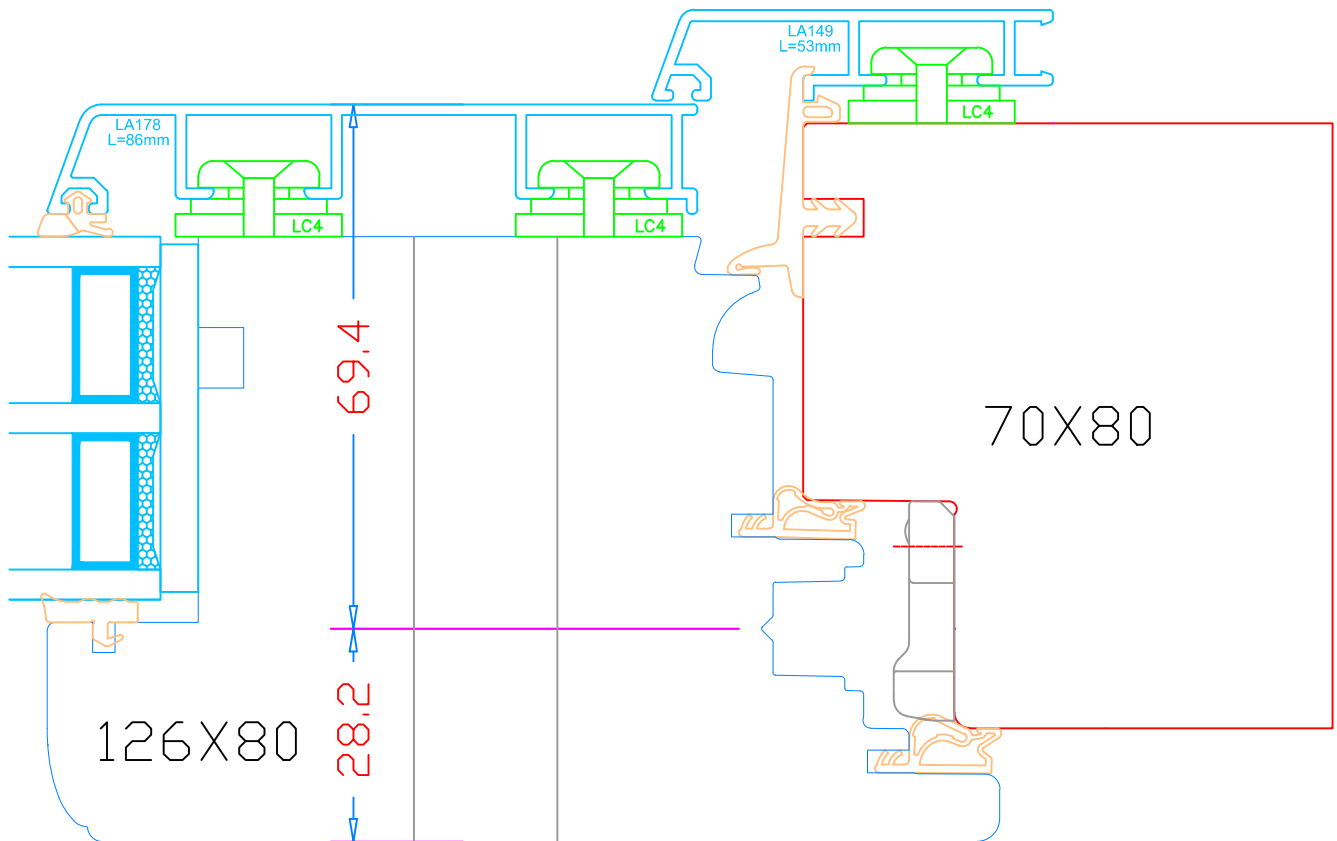

Ouverture intérieure

Dimension de cylindre (EXT/INT)			
	Atlanta	Enraygues	Normbau
UNI 9	80/40	75/35	80/40

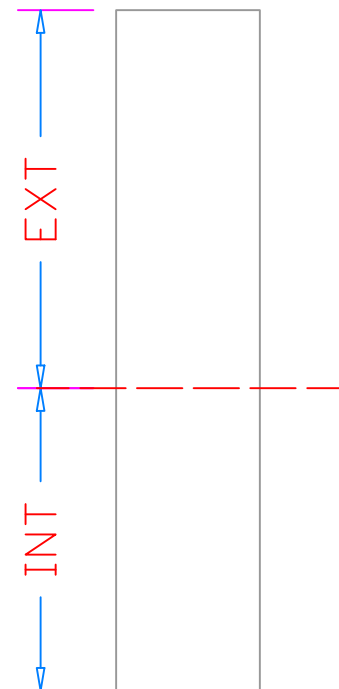

Ouverture extérieure

Dimension de cylindre (EXT/INT)			
	Atlanta	Enraygues	Normbau
UNI 9	50/60	45/55	55/65

Module extérieur en option

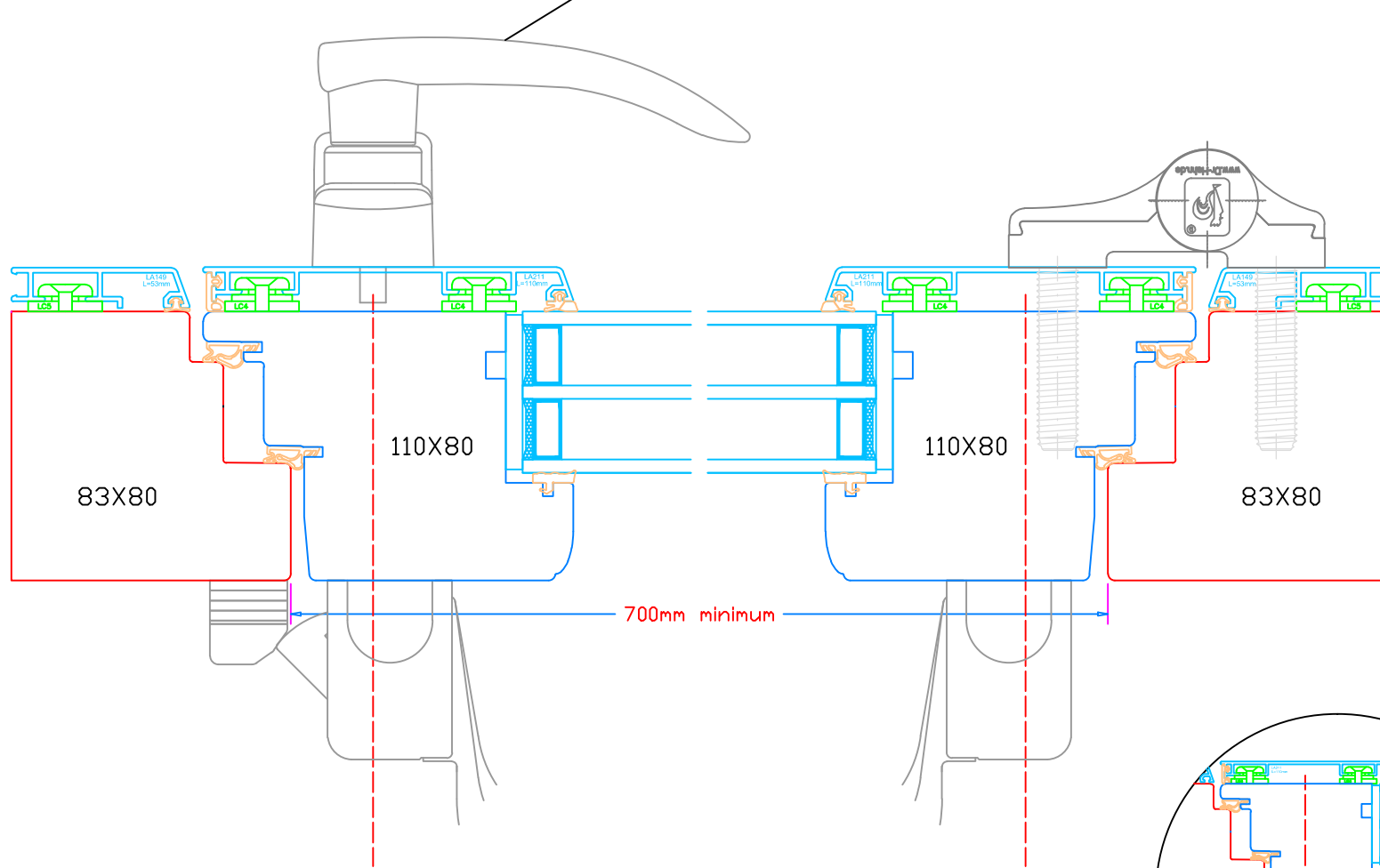
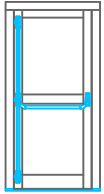

PASSAGE



Attention, le passage entre les montants du dormant doit être de 700 mm au minimum.

PUSH

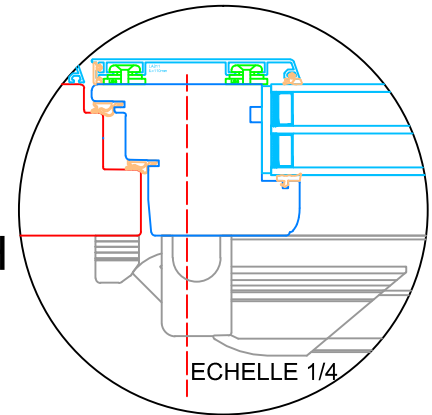

Module extérieur en option

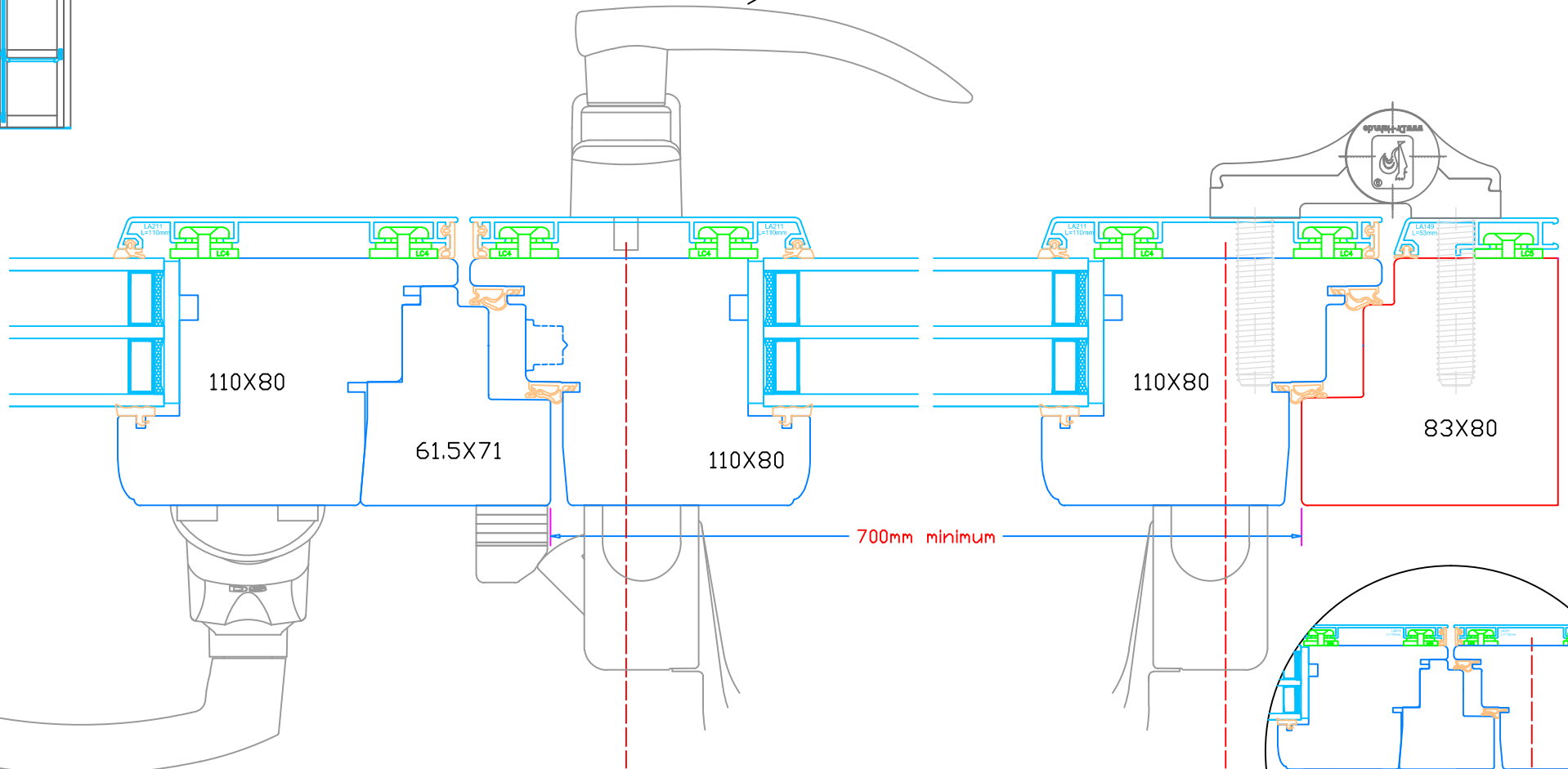
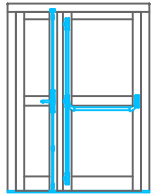

PUSH

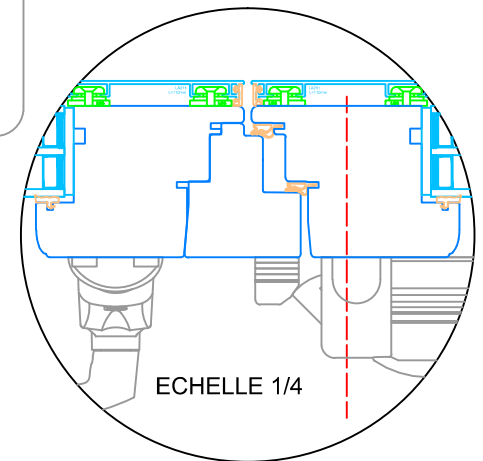

PASSAGE



Attention, le passage entre le montant est le battement central doit être de 700 mm au minimum.

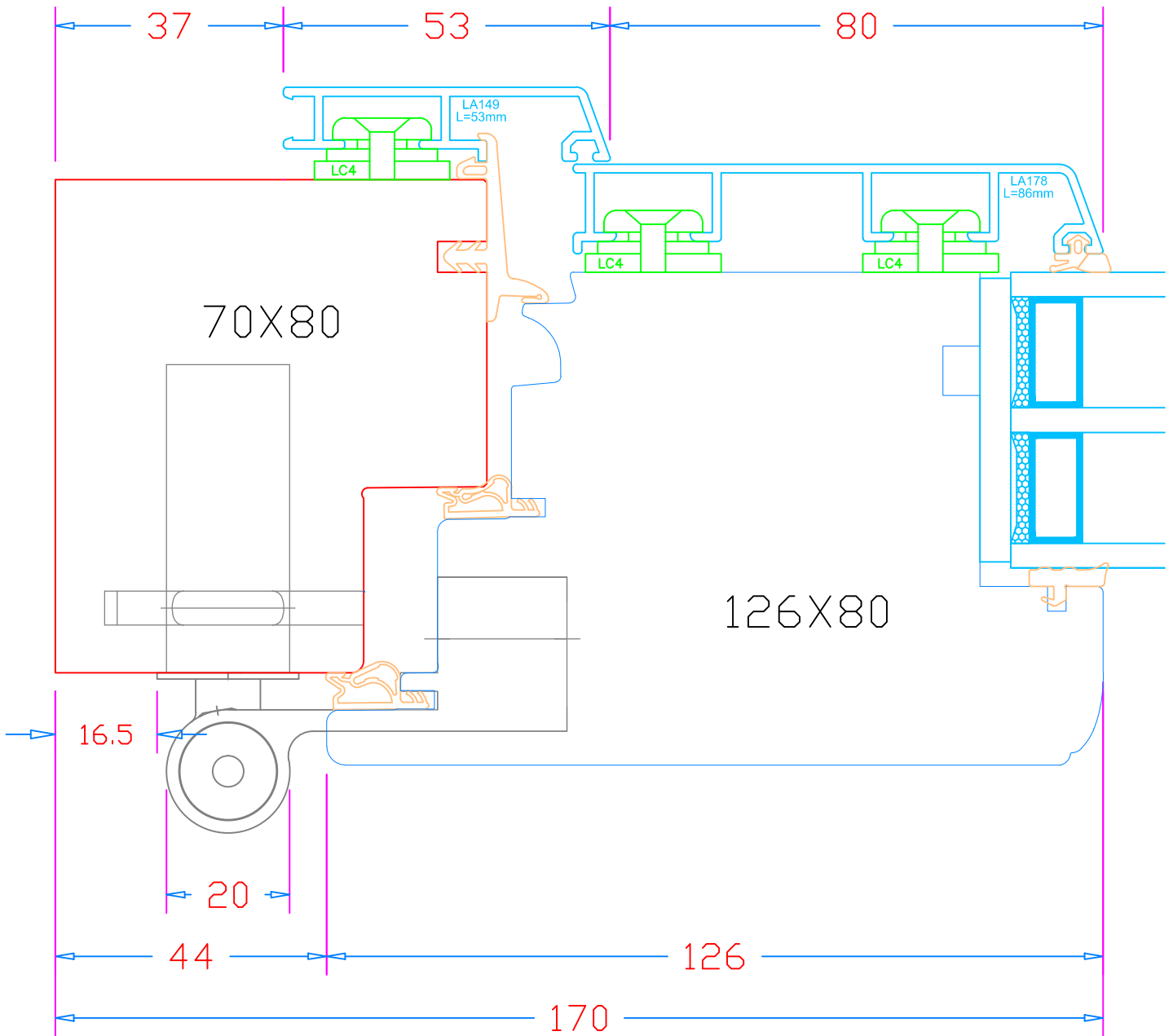
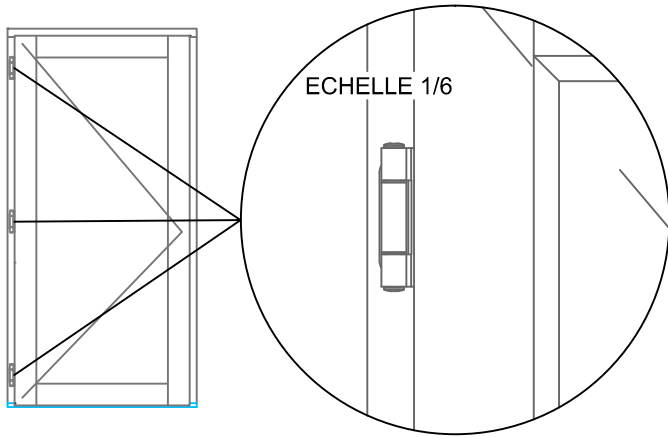

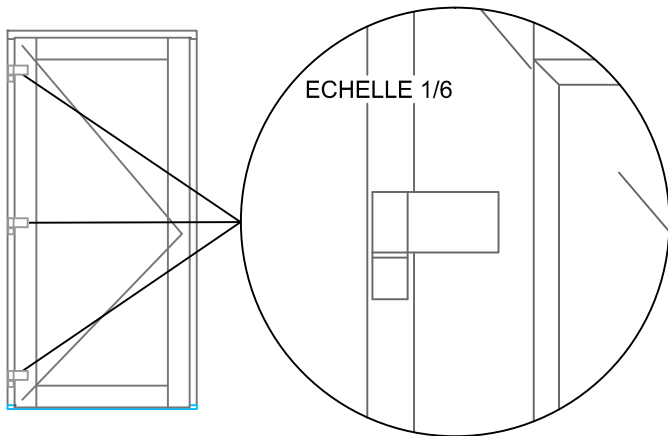

DEGONDAGE



Attention, en partie haute, il faut prévoir un jeu de 47 mm au dessus de l'ouvrant, pour pouvoir dégondage l'ouvrant.

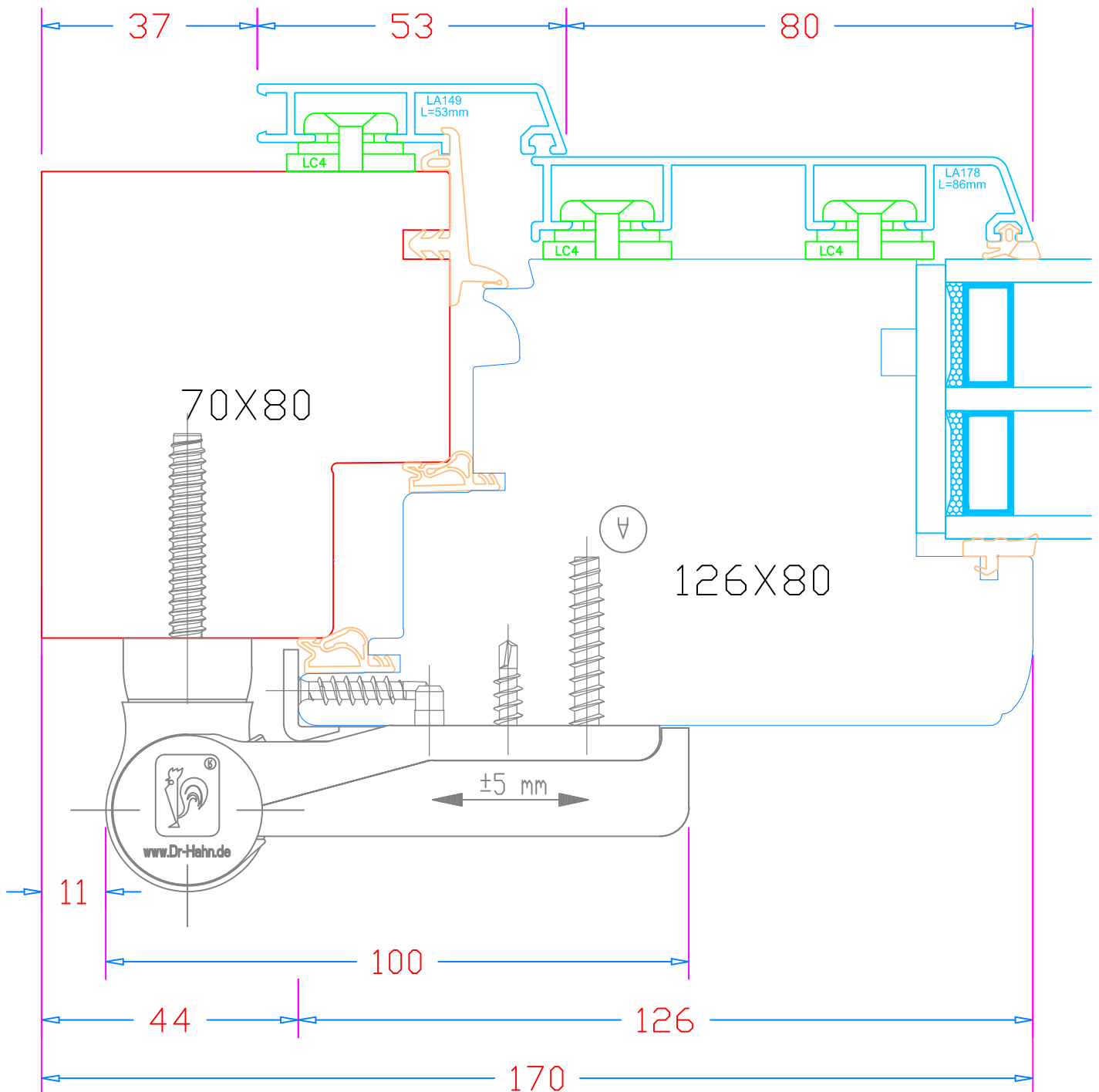

Coupes Standard

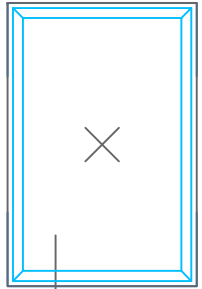

Coupe 01

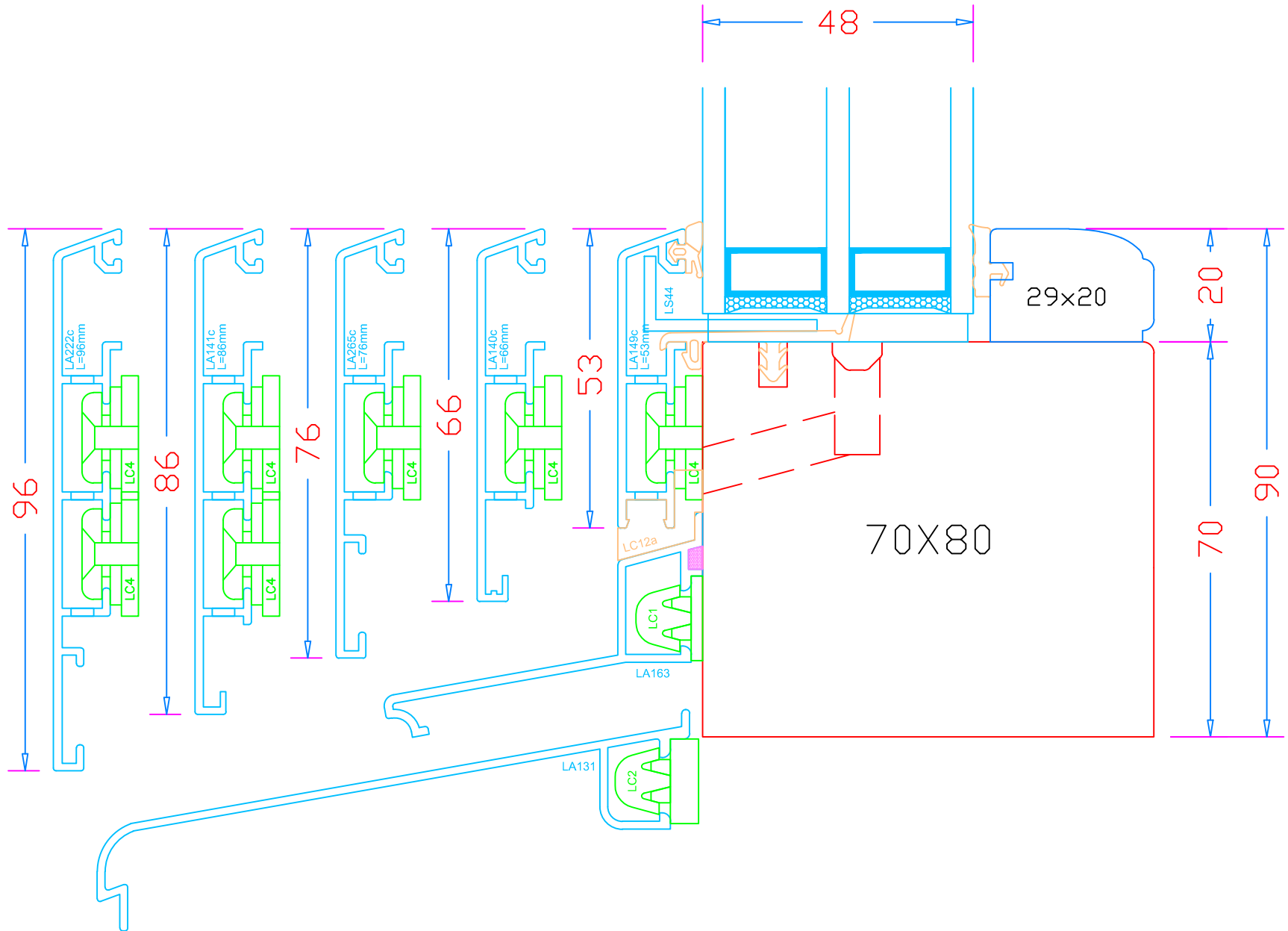

Coupe 02

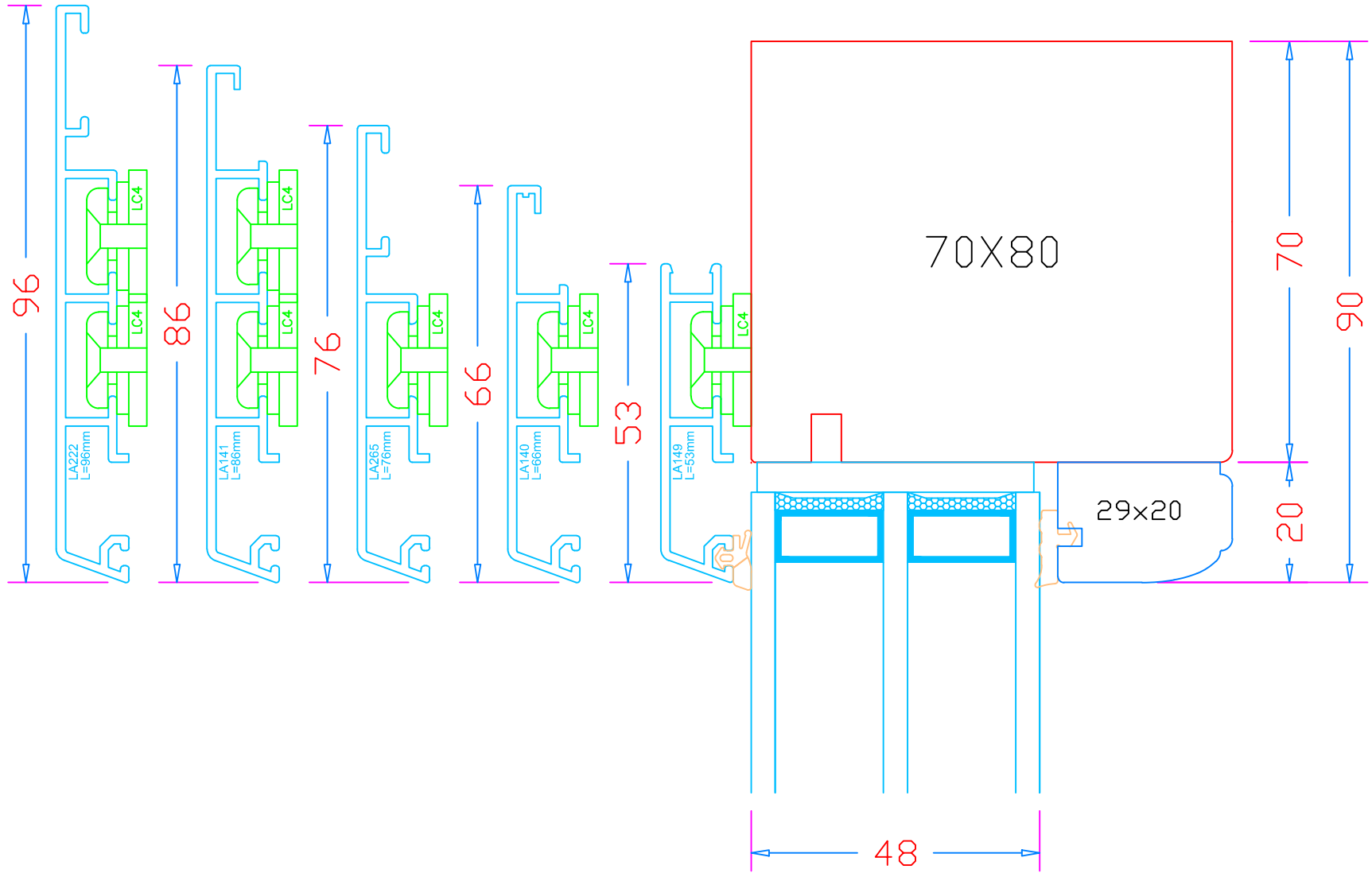
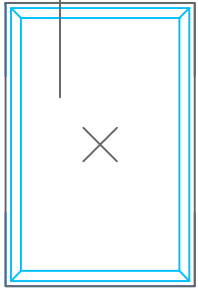

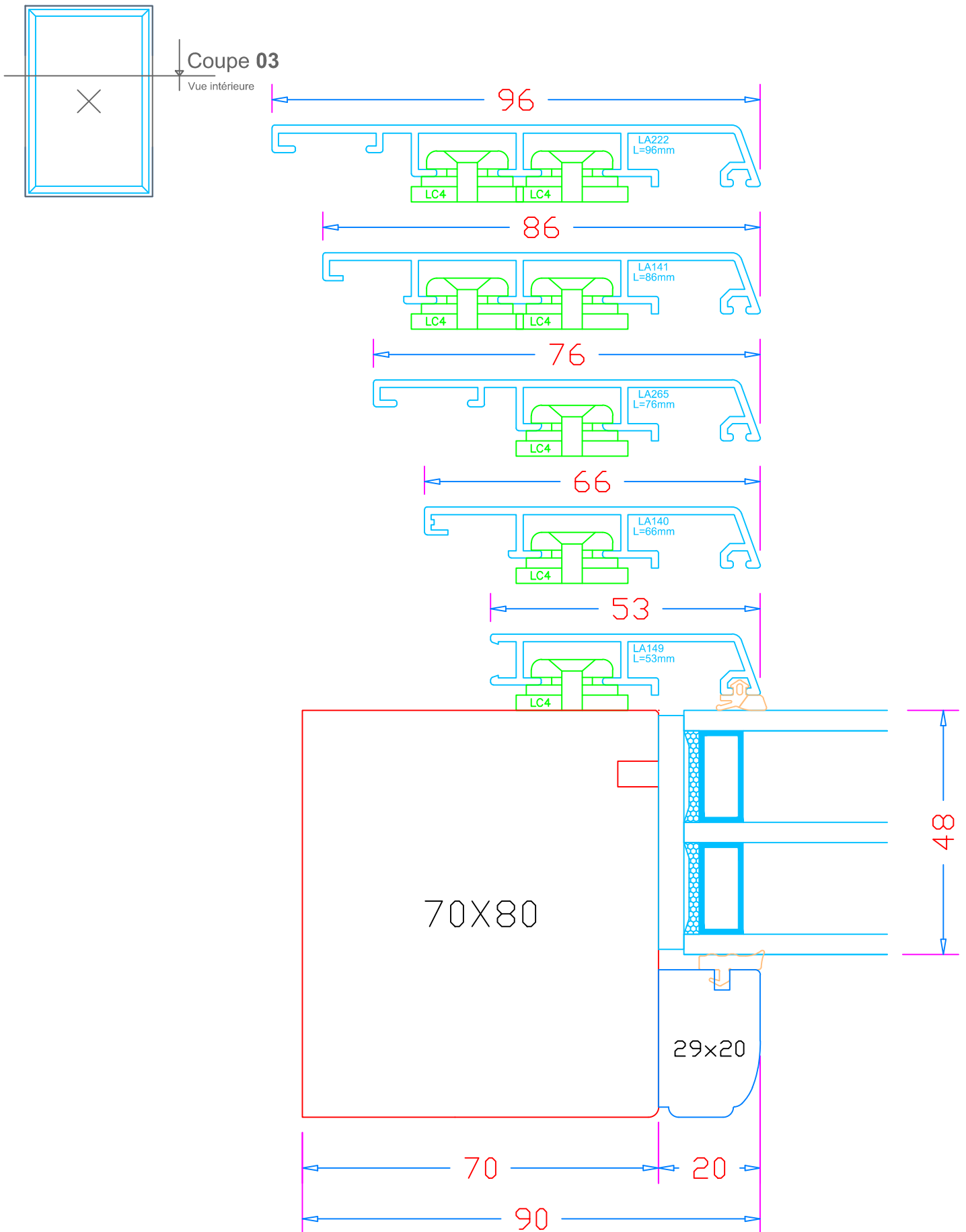

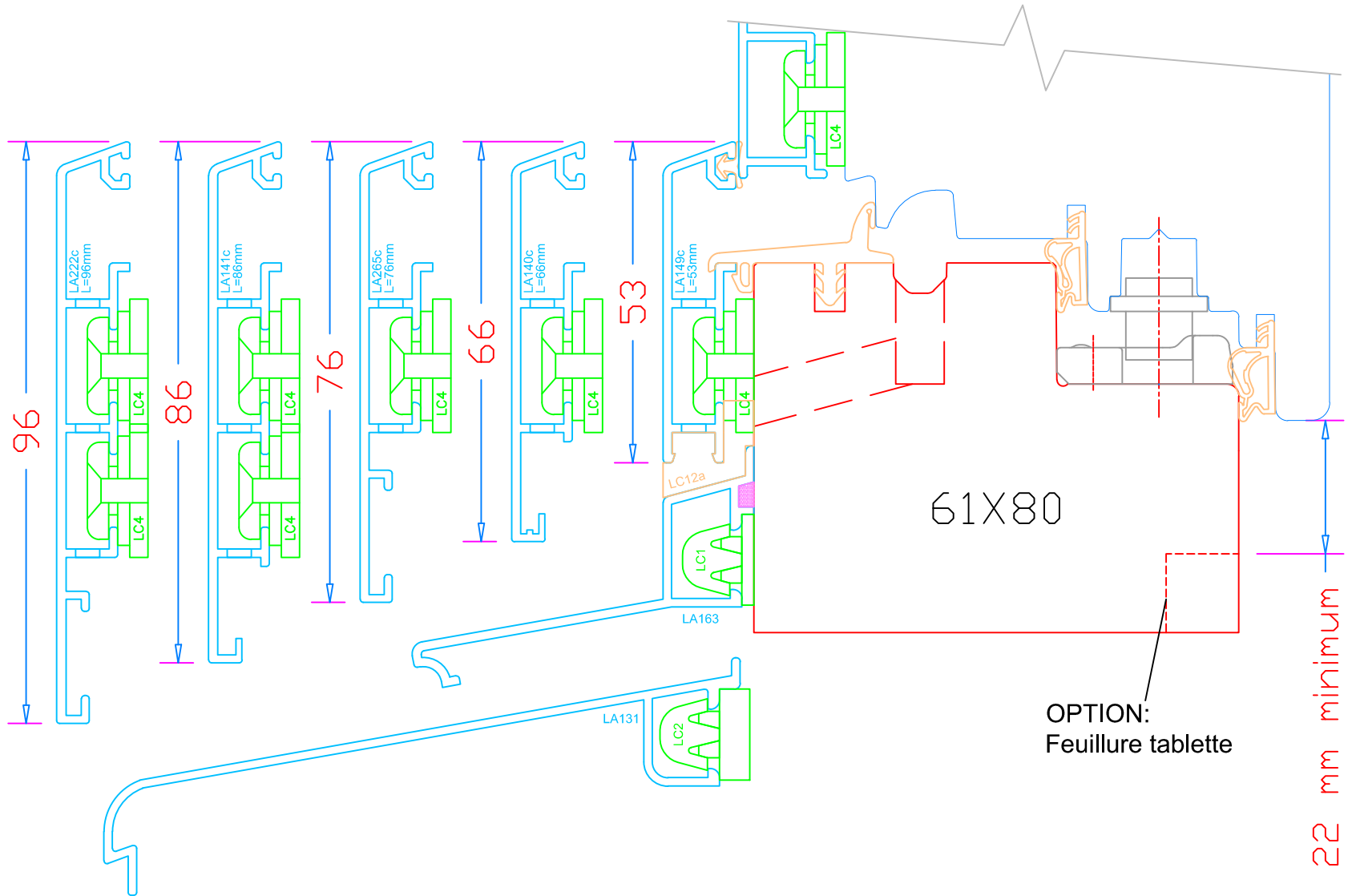
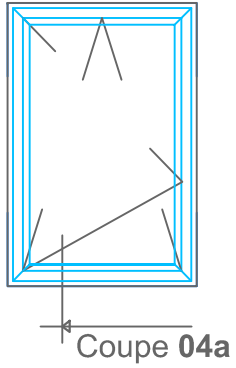

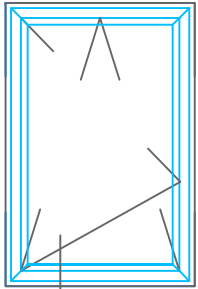

Coupe 04b

Largeur possible de bavette

50mm	150mm	225mm	320mm
70mm	165mm	240mm	360mm
90mm	180mm	260mm	400mm
110mm	195mm	280mm	X
130mm	210mm	300mm	X

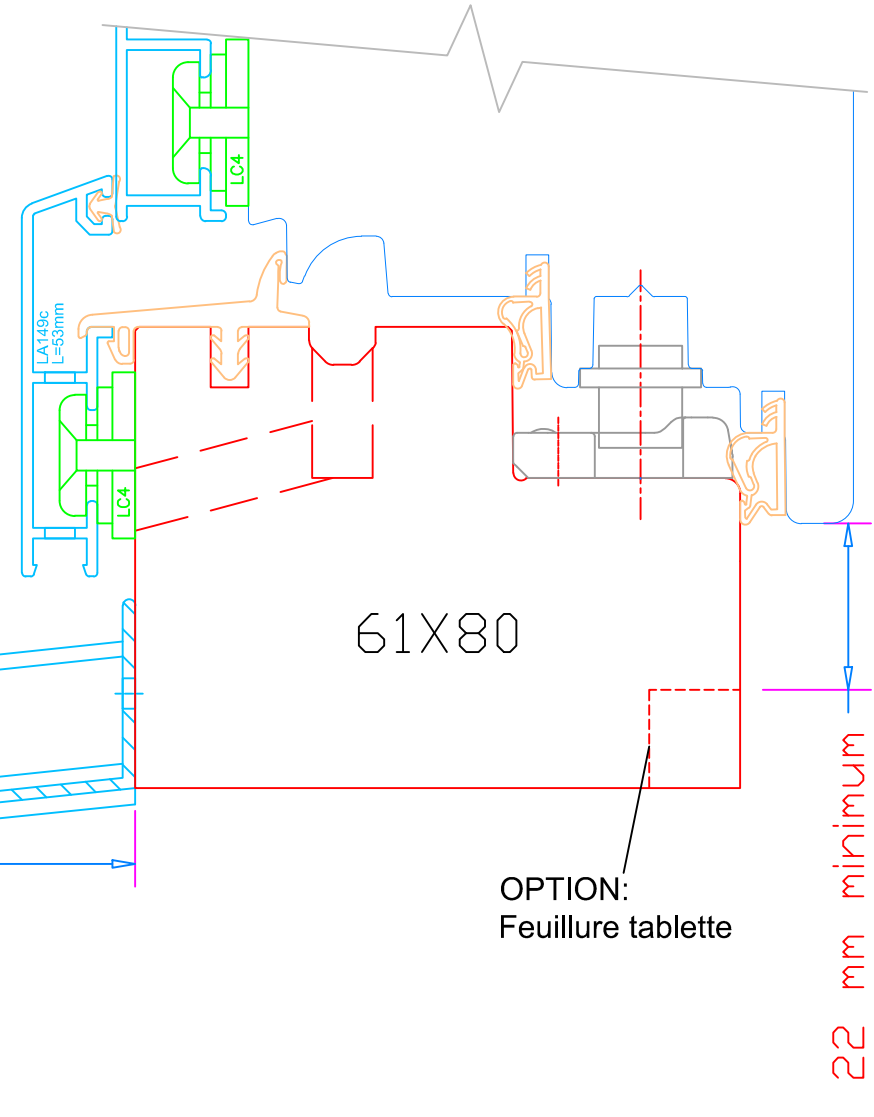

Largeur bavette

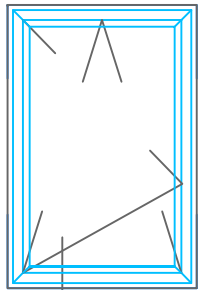

OPTION:
Feuillure tablette

22 mm minimum

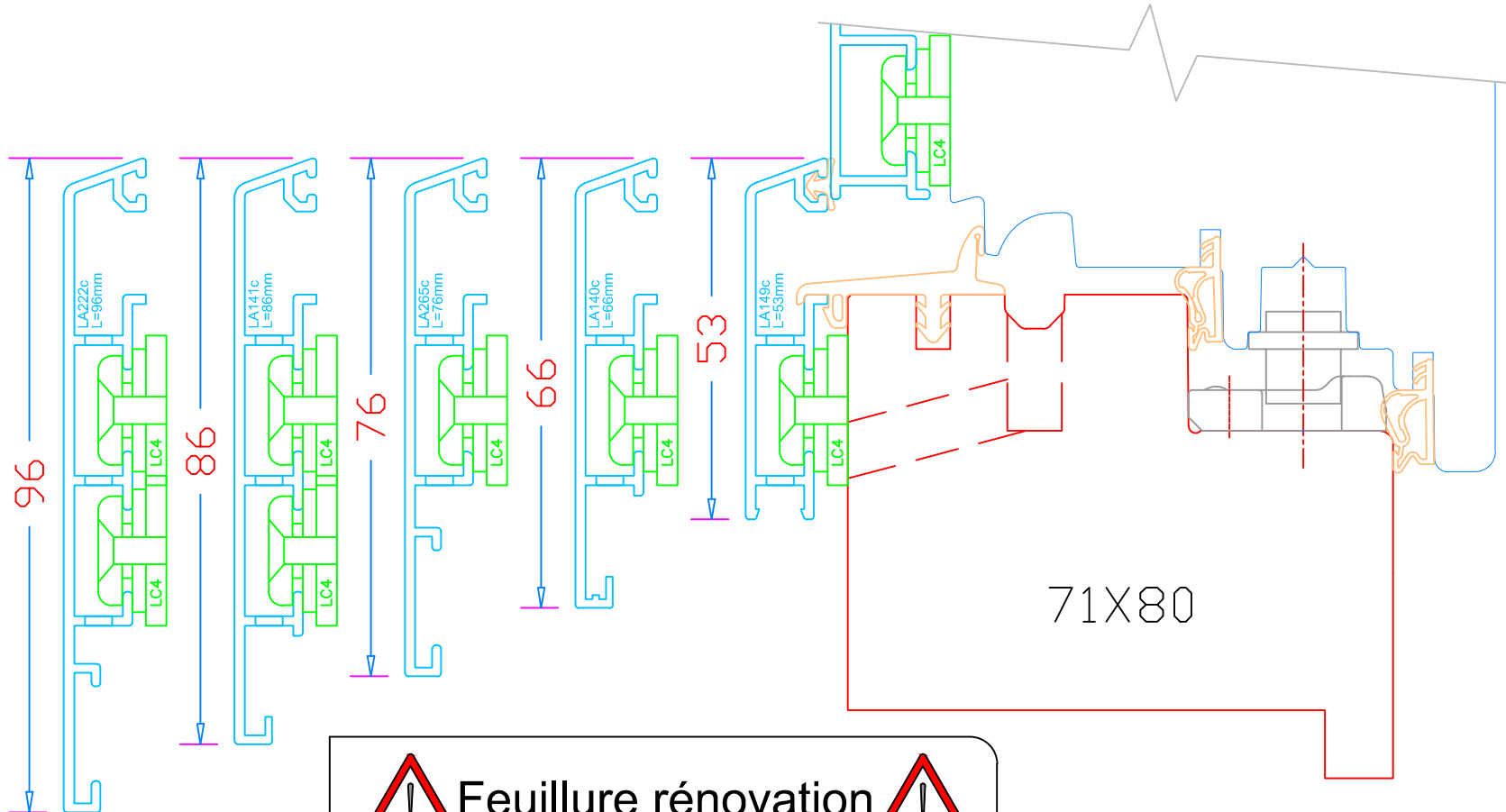

Coupe 04c



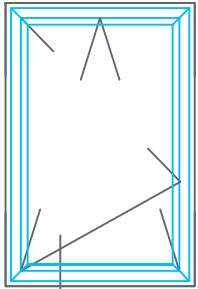

Feuillure rénovation

La feuillure rénovation est définie en fonction de la pose du chantier et du profil aluminium utilisé. Faire une demande de faisabilité.

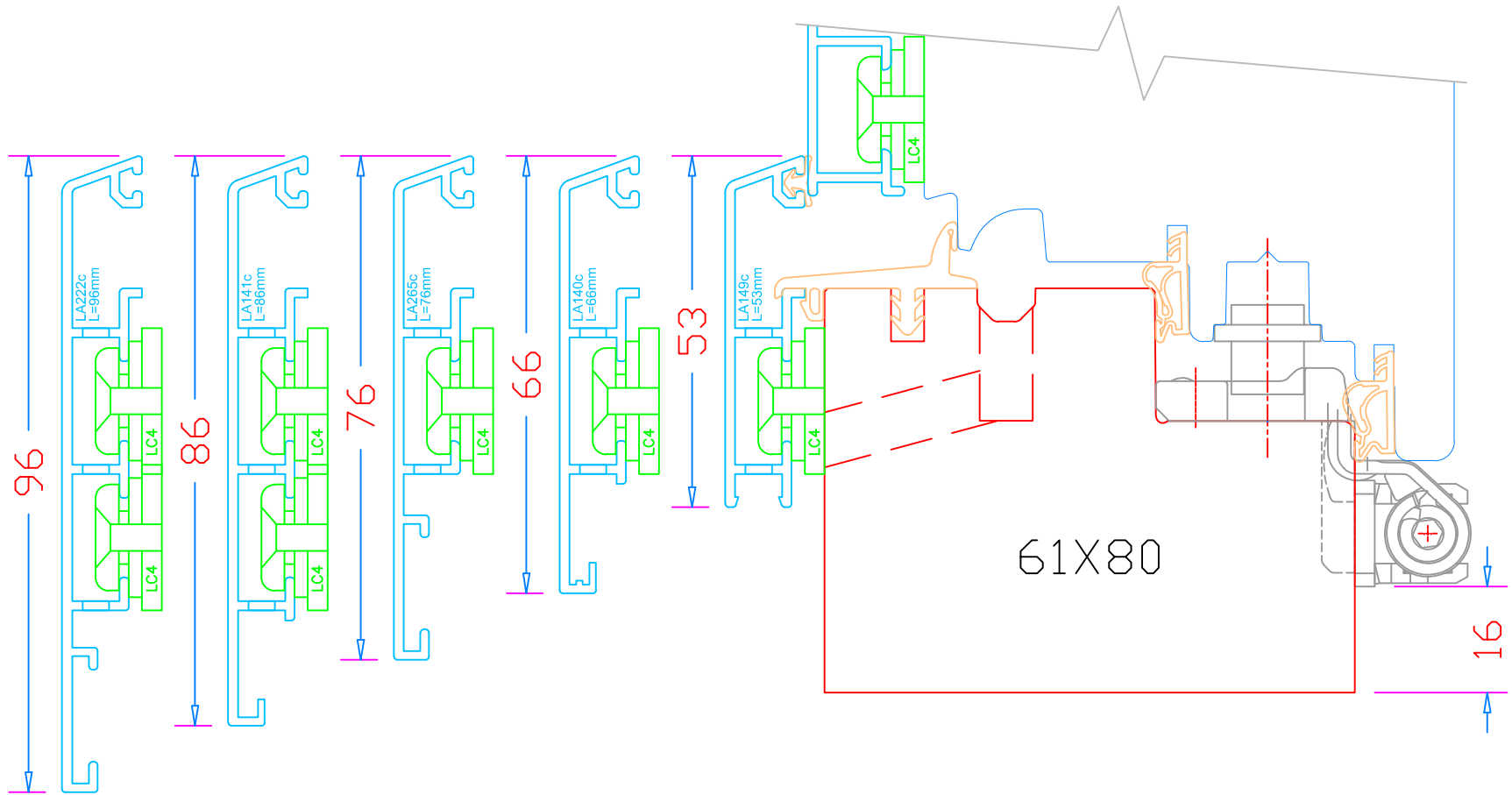

Coupe 04d

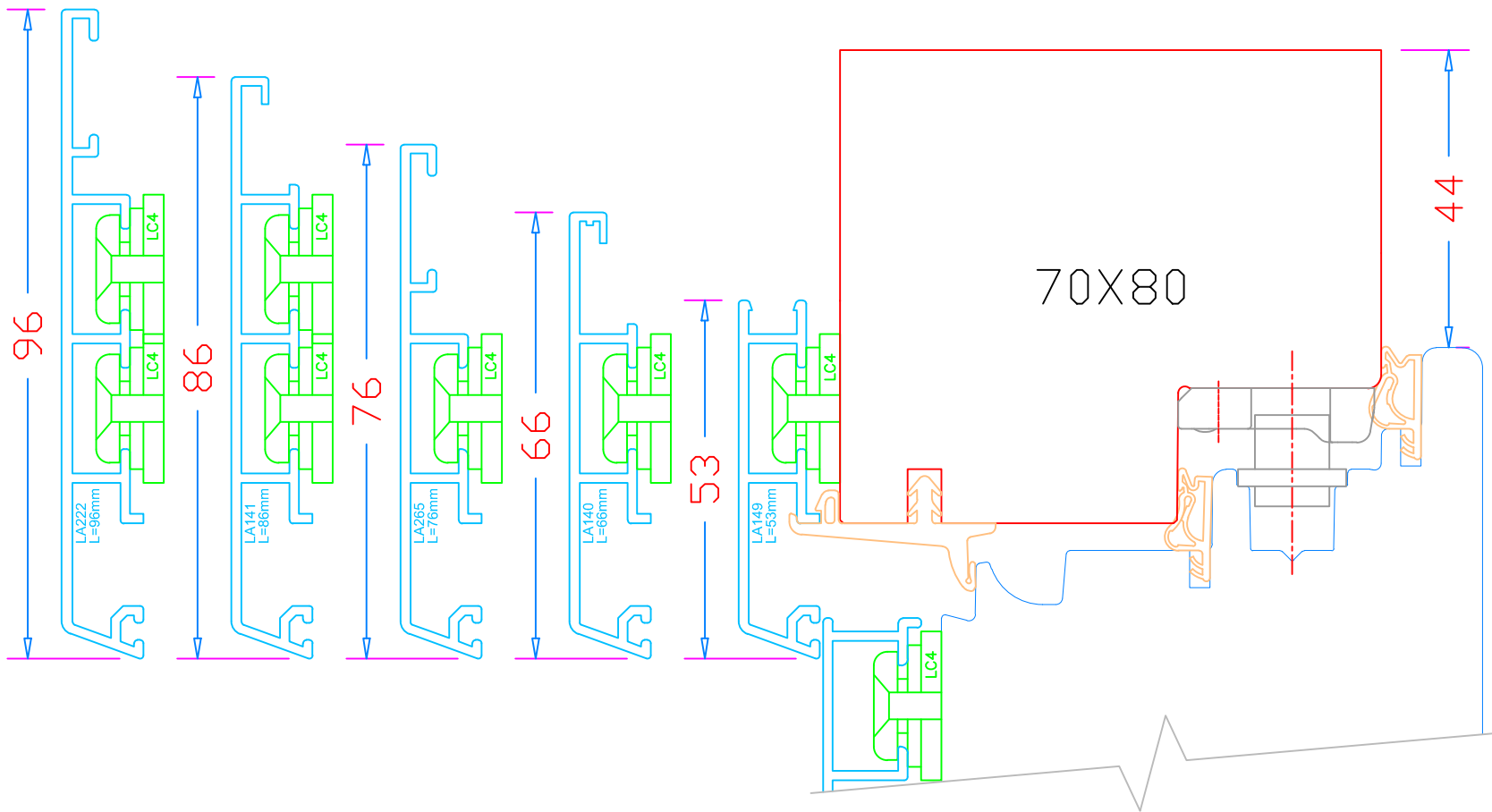
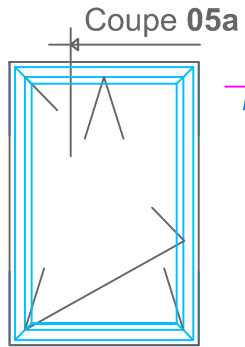



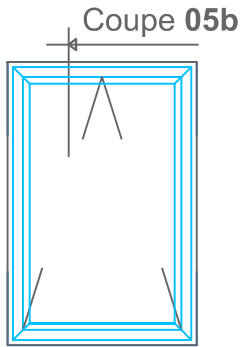

Pour les autres
profils aluminium
voir coupe C05a

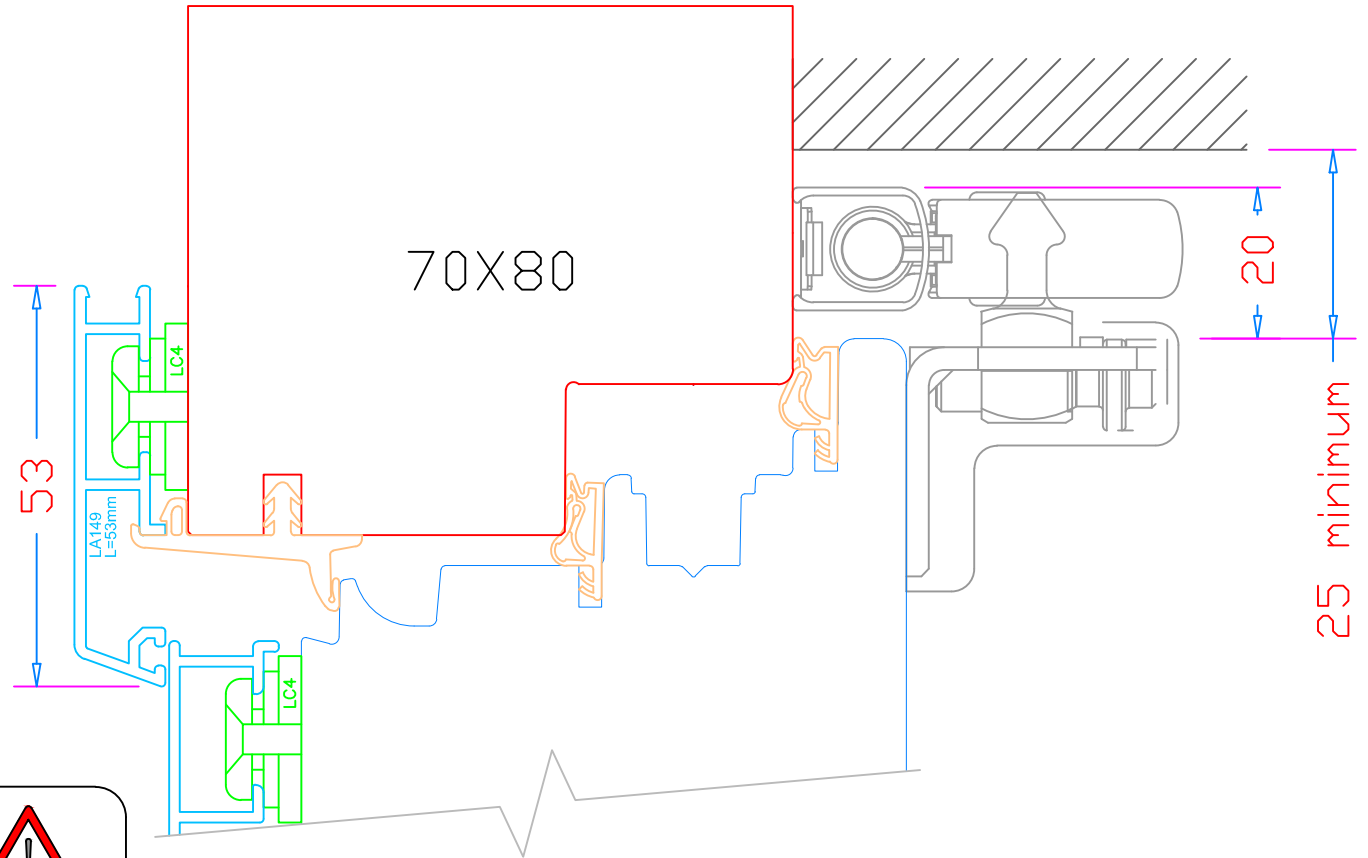

ENCOMBREMENT

Attention, il faut prévoir un encombrement minimum de 25 mm entre le joue de l'ouvrant et le retour du tableau, pour permettre le passage du ferme-imposte.

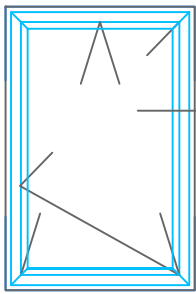

Coupe 06a

Vue intérieure

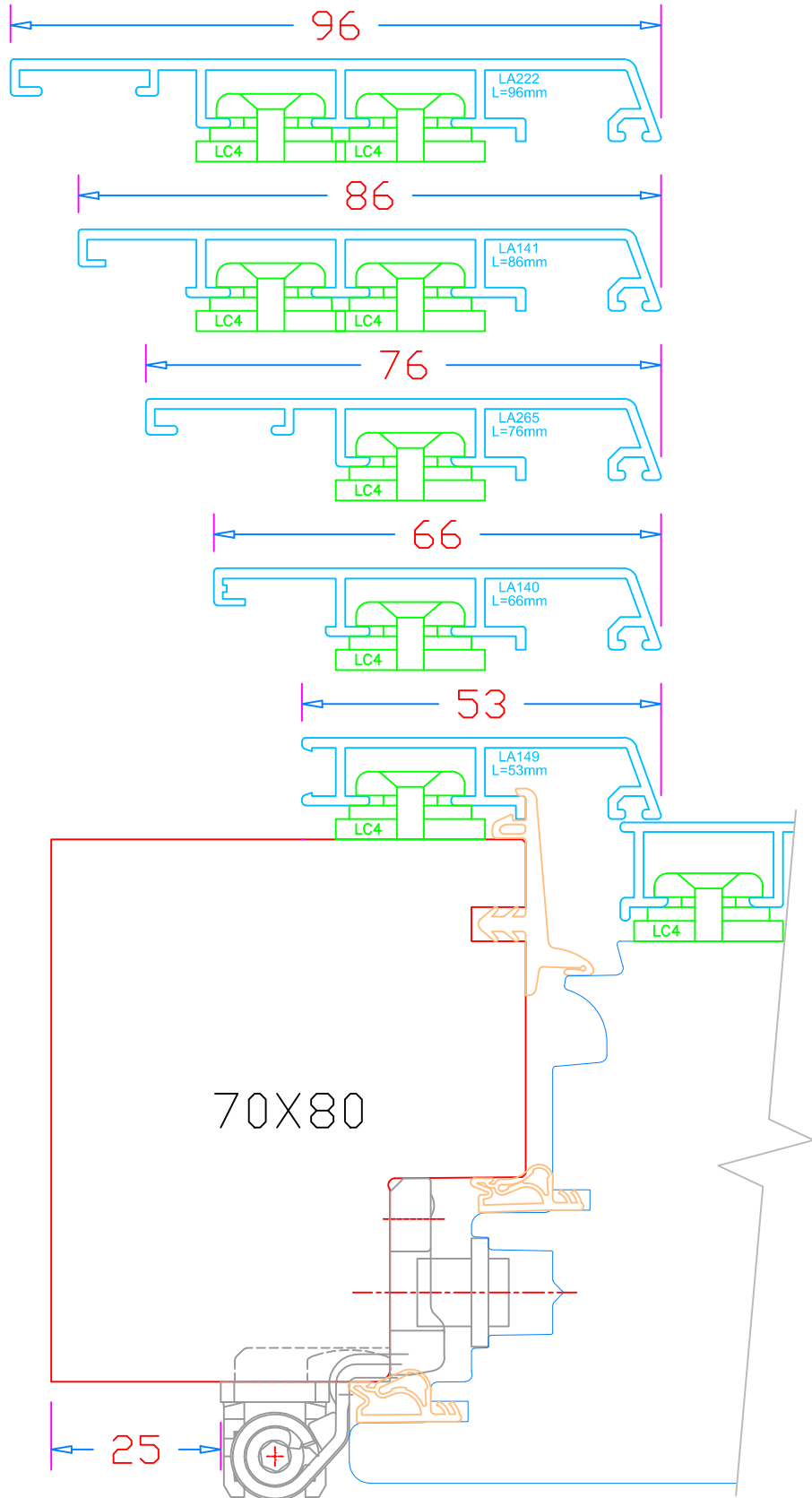

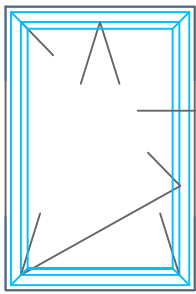

Coupe 06b

Vue intérieure

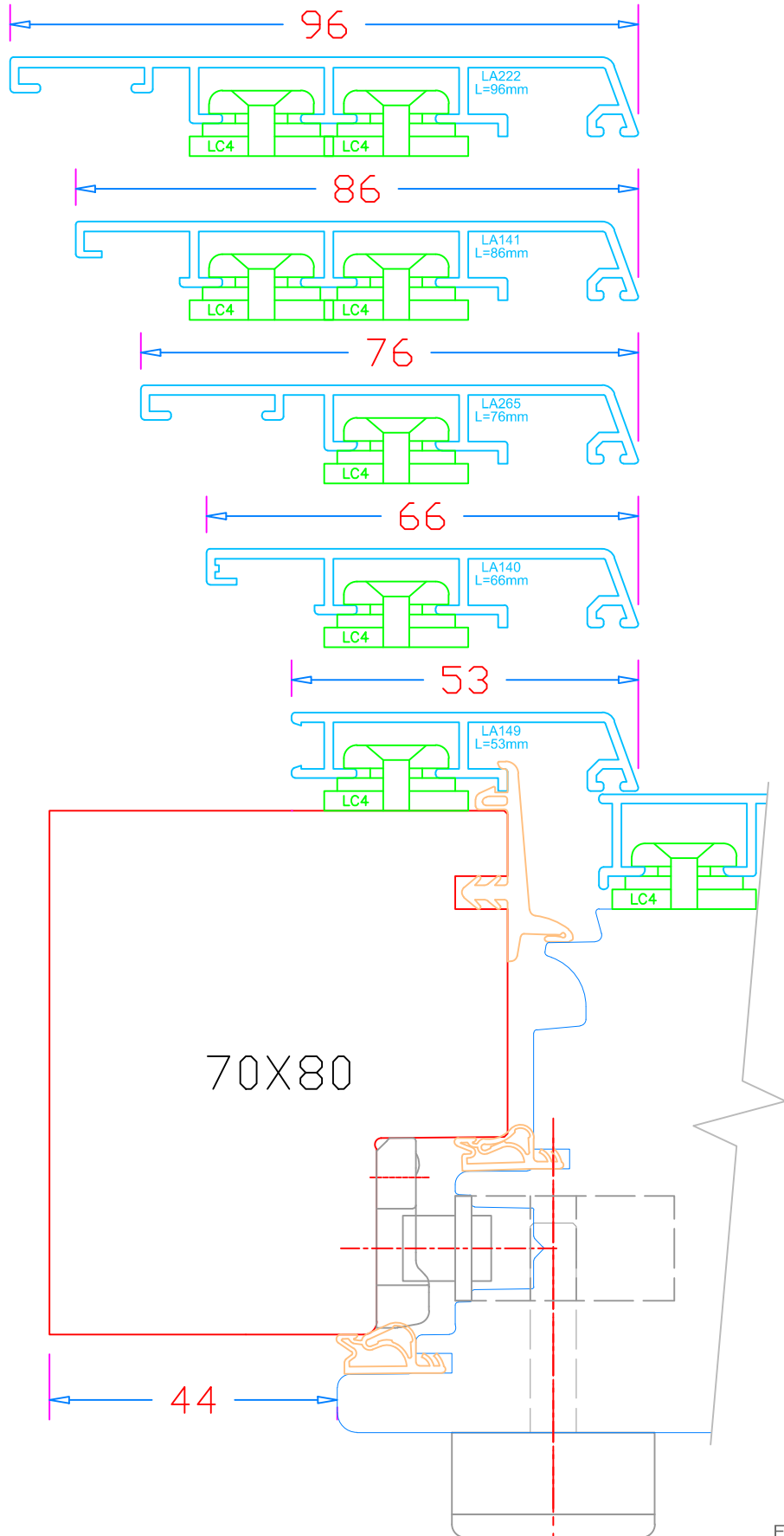

Coupe 08a

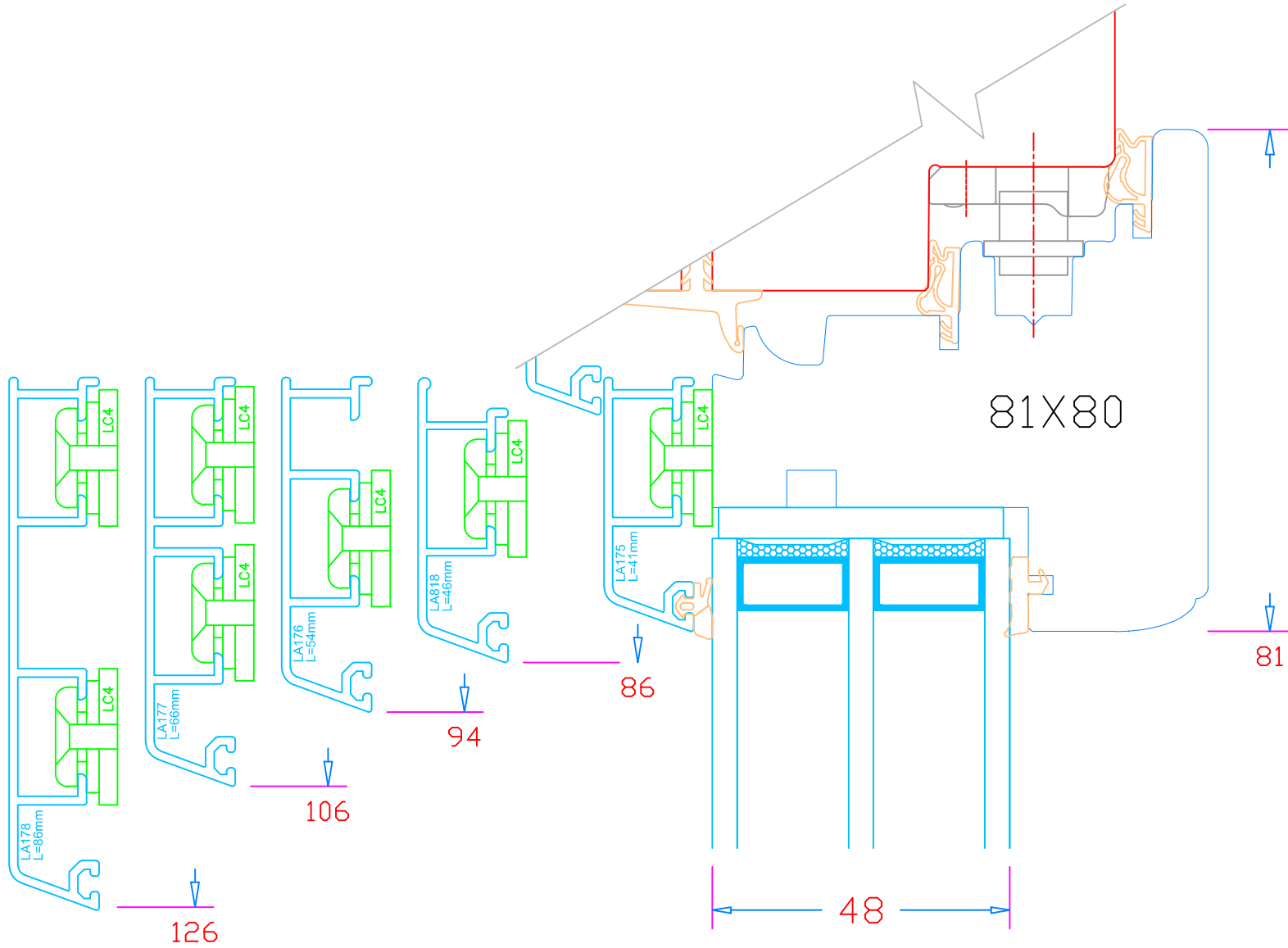
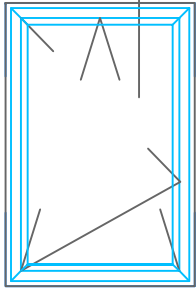

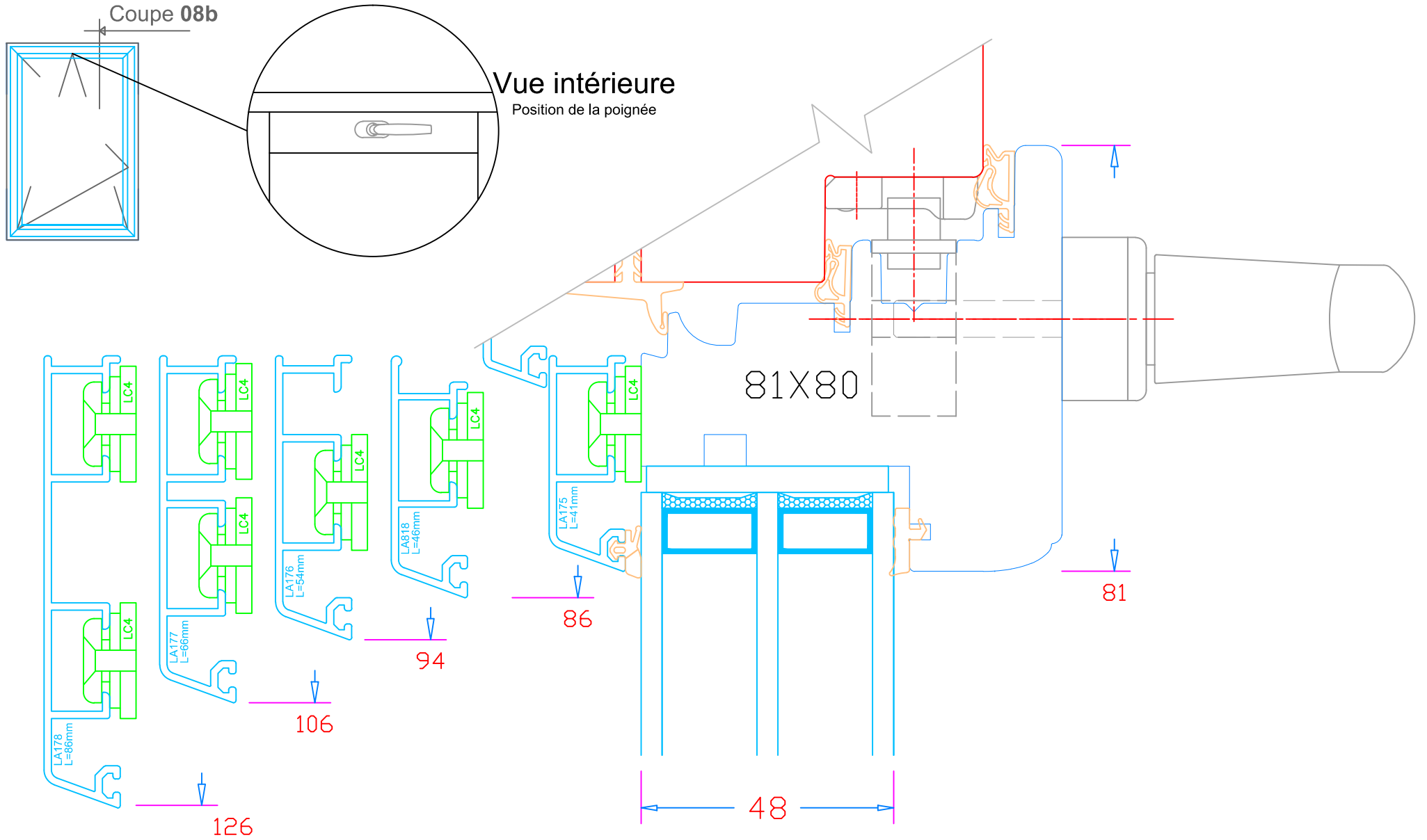

Coupe 08c

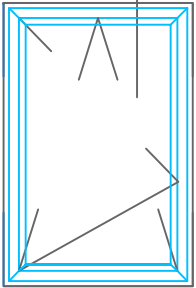

Largeur ouvrant



Attention, lorsque qu'il y a une VMC, la traverse haute doit être élargie à une largeur minimale de 94mm.

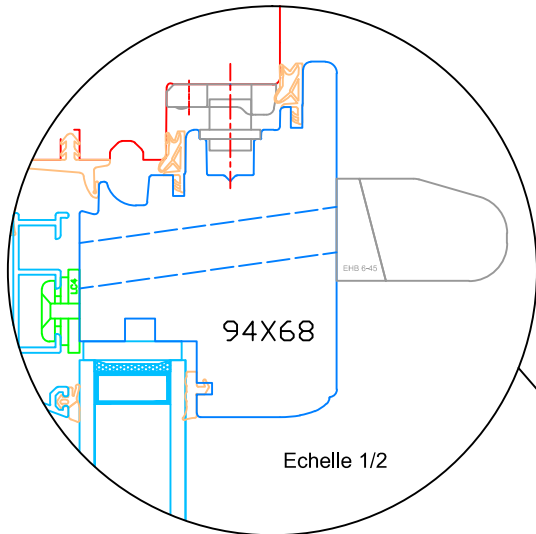
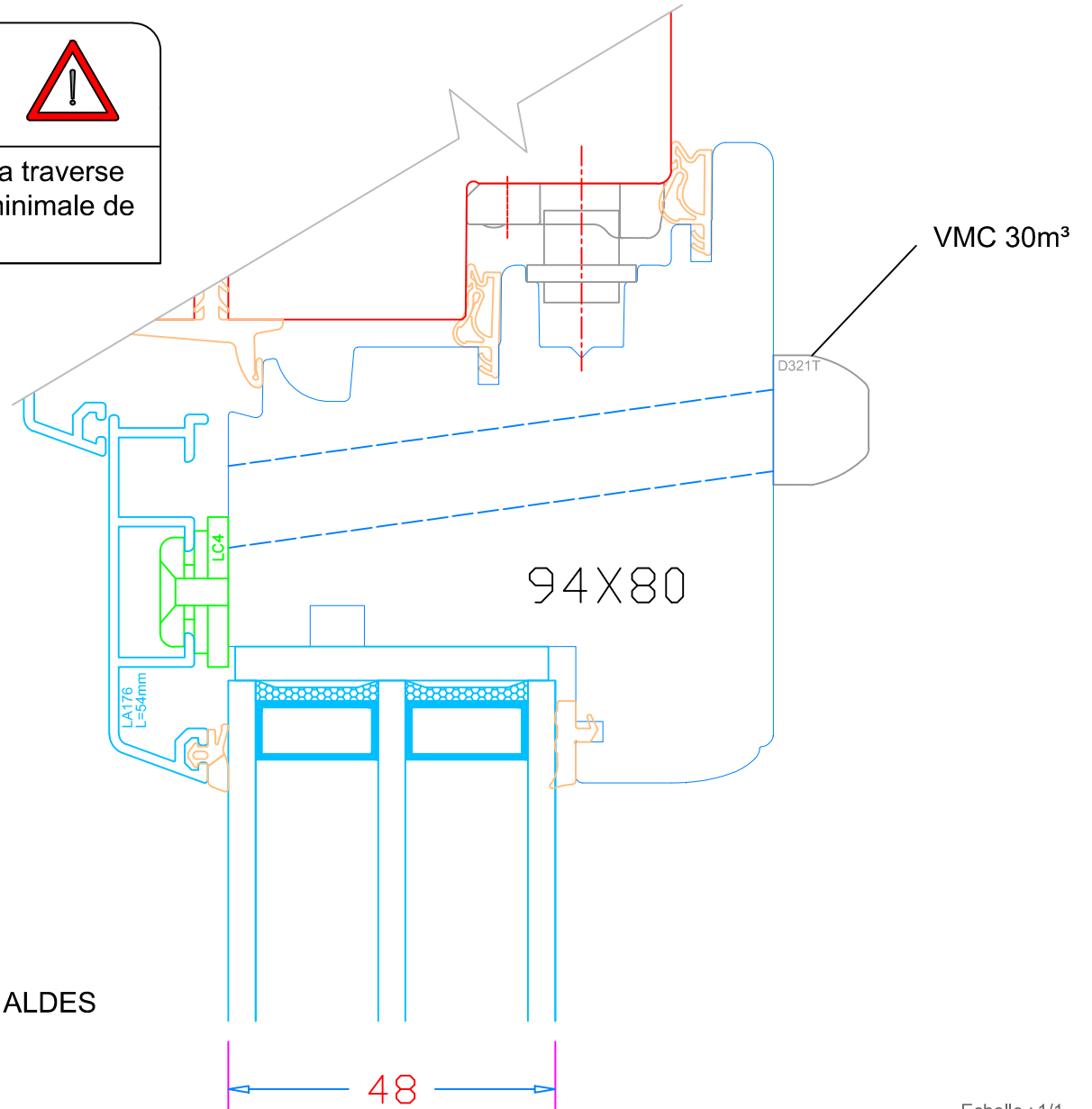

VMC Hygroréglable ALDES

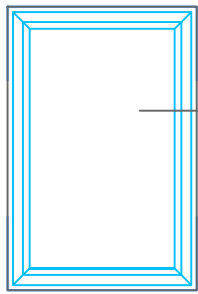

Coupe 09
 Vue intérieure

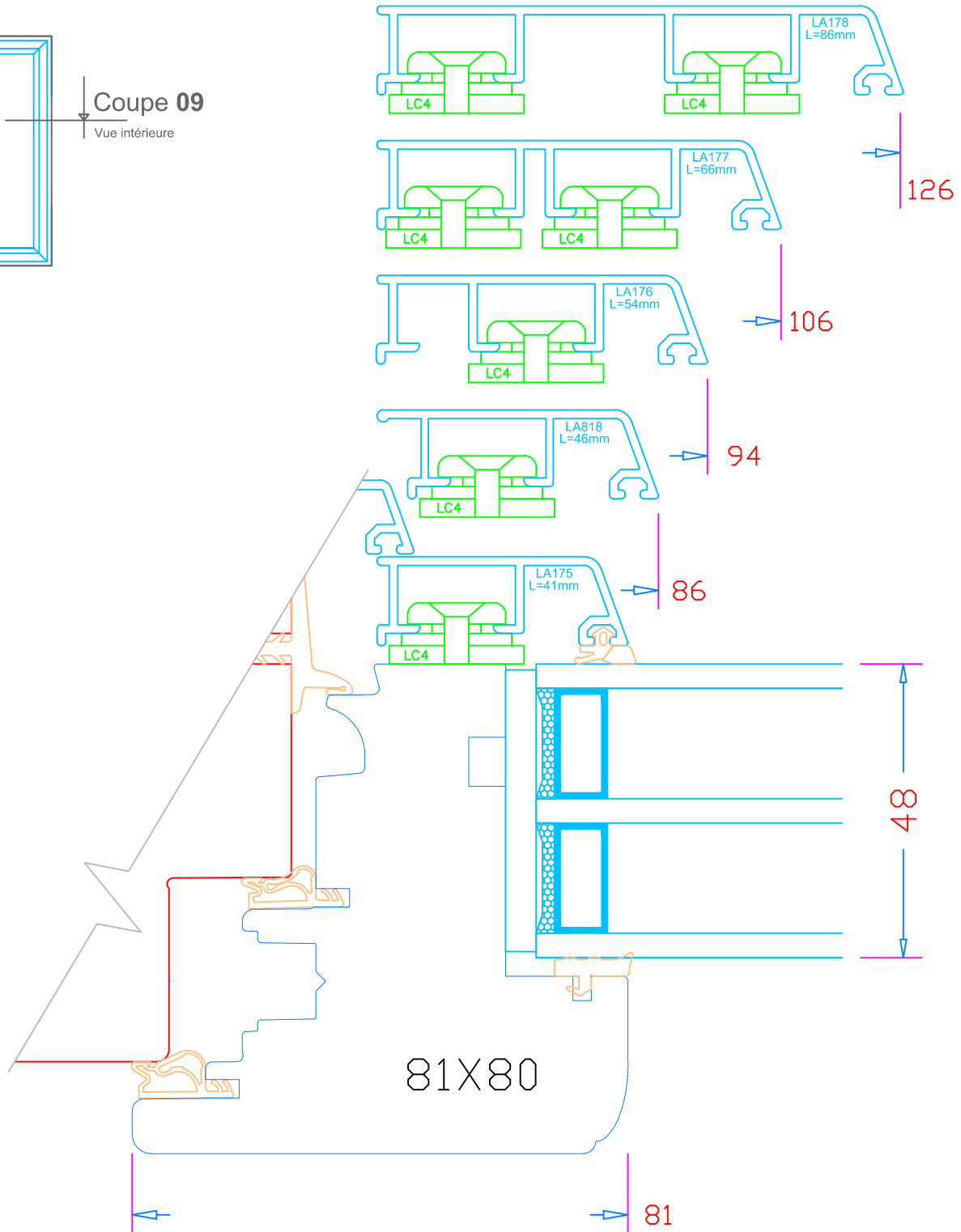

Coupe 10
 Vue intérieure

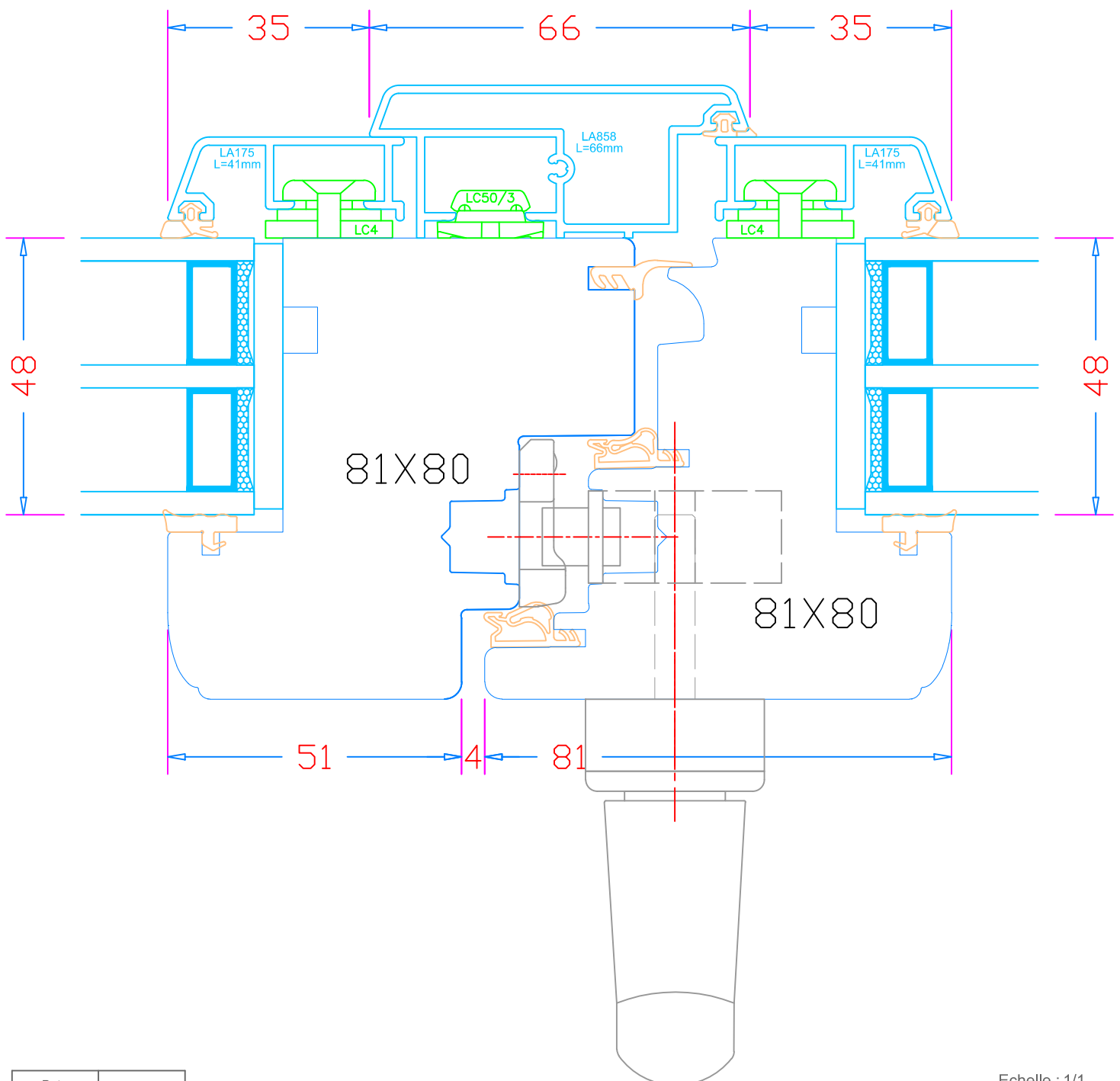
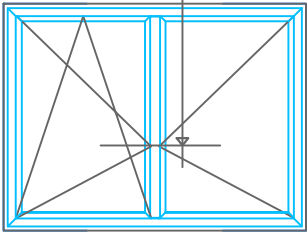

Date	17/10/2014
------	------------

Echelle : 1/1

Coupe 11
Vue intérieure

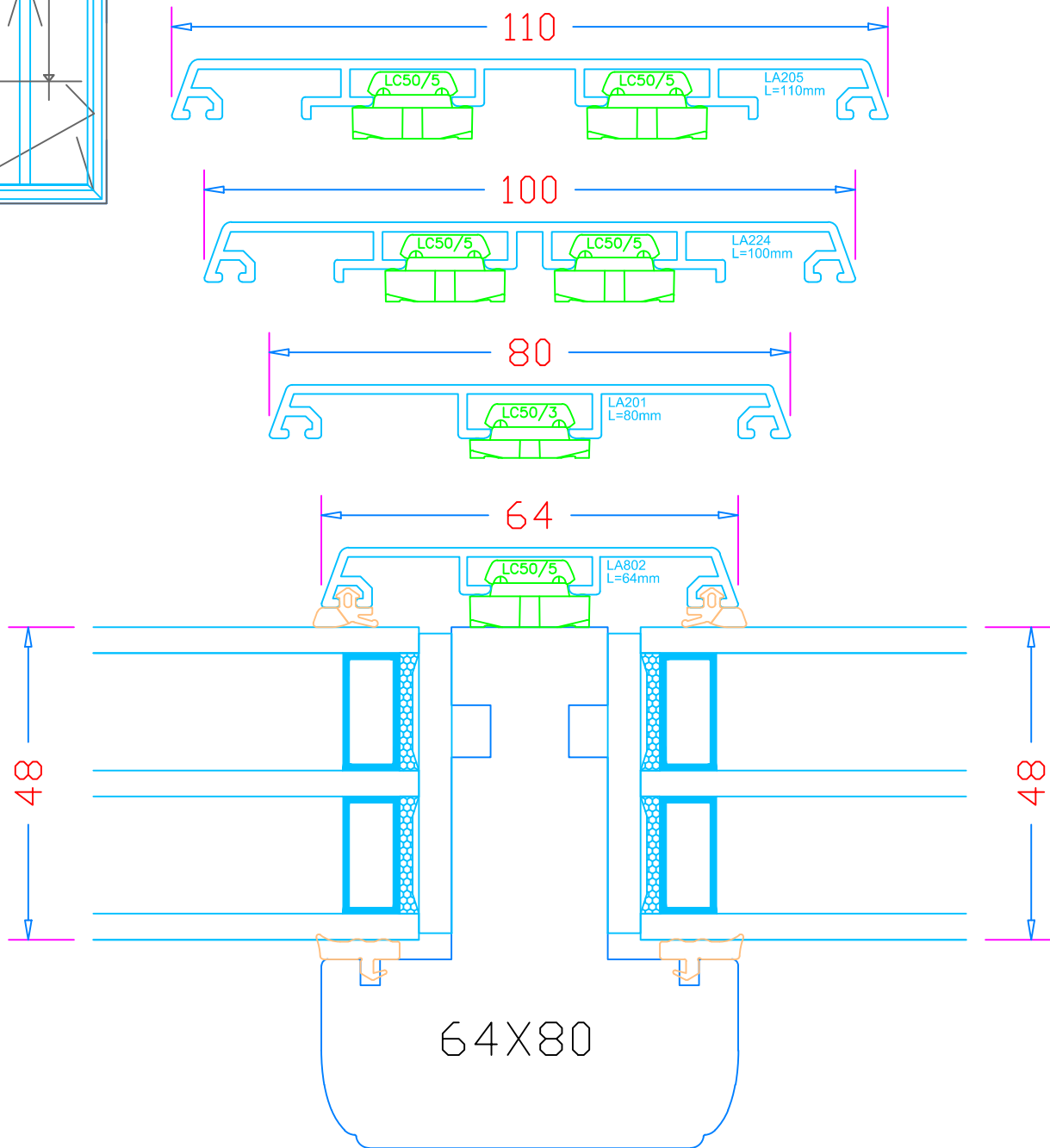
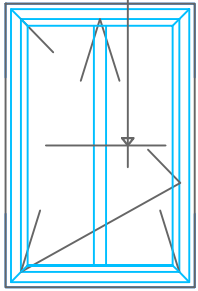

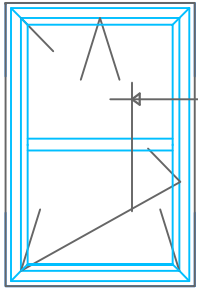

Coupe 12

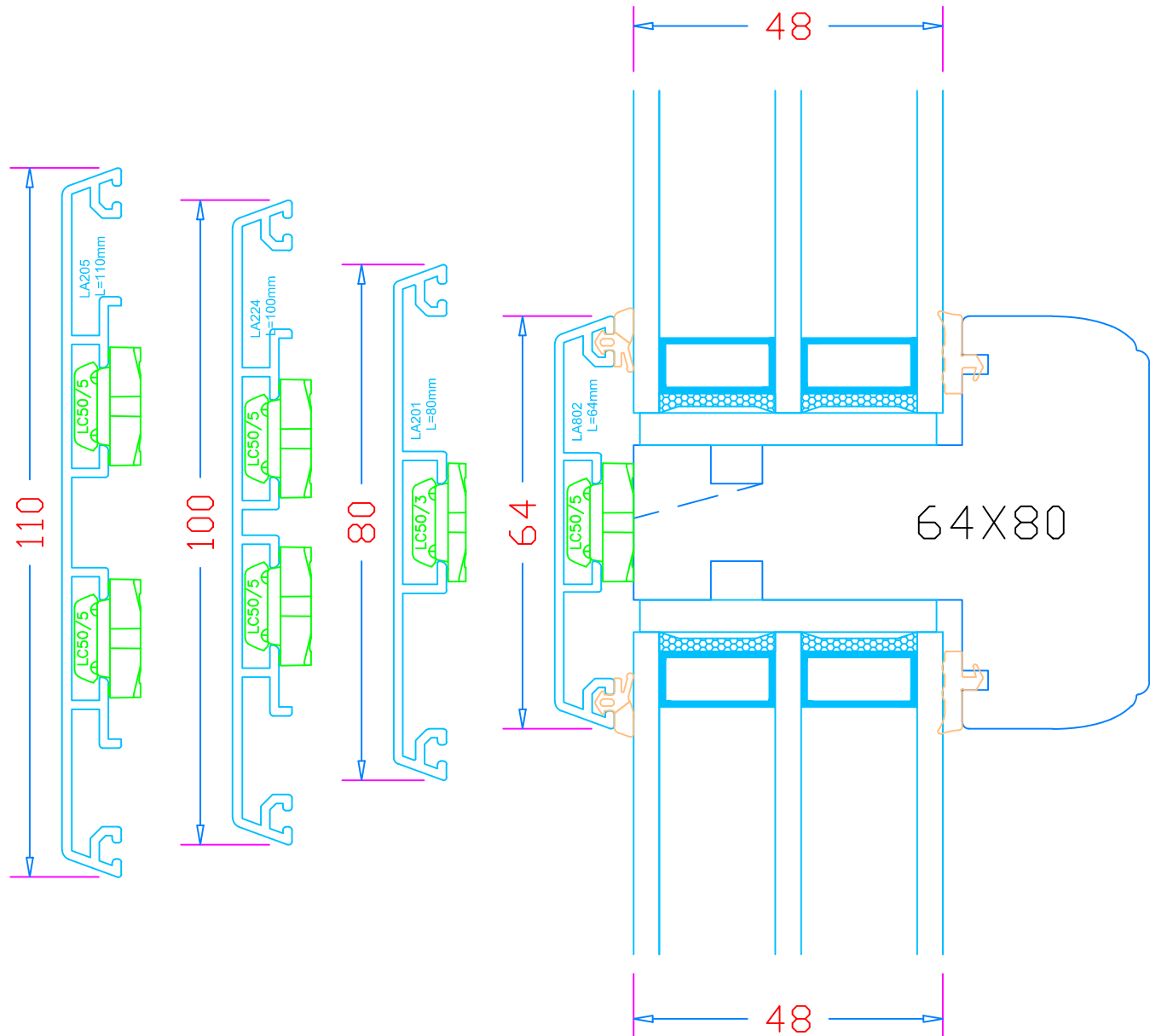

Coupe 13
 Vue intérieure

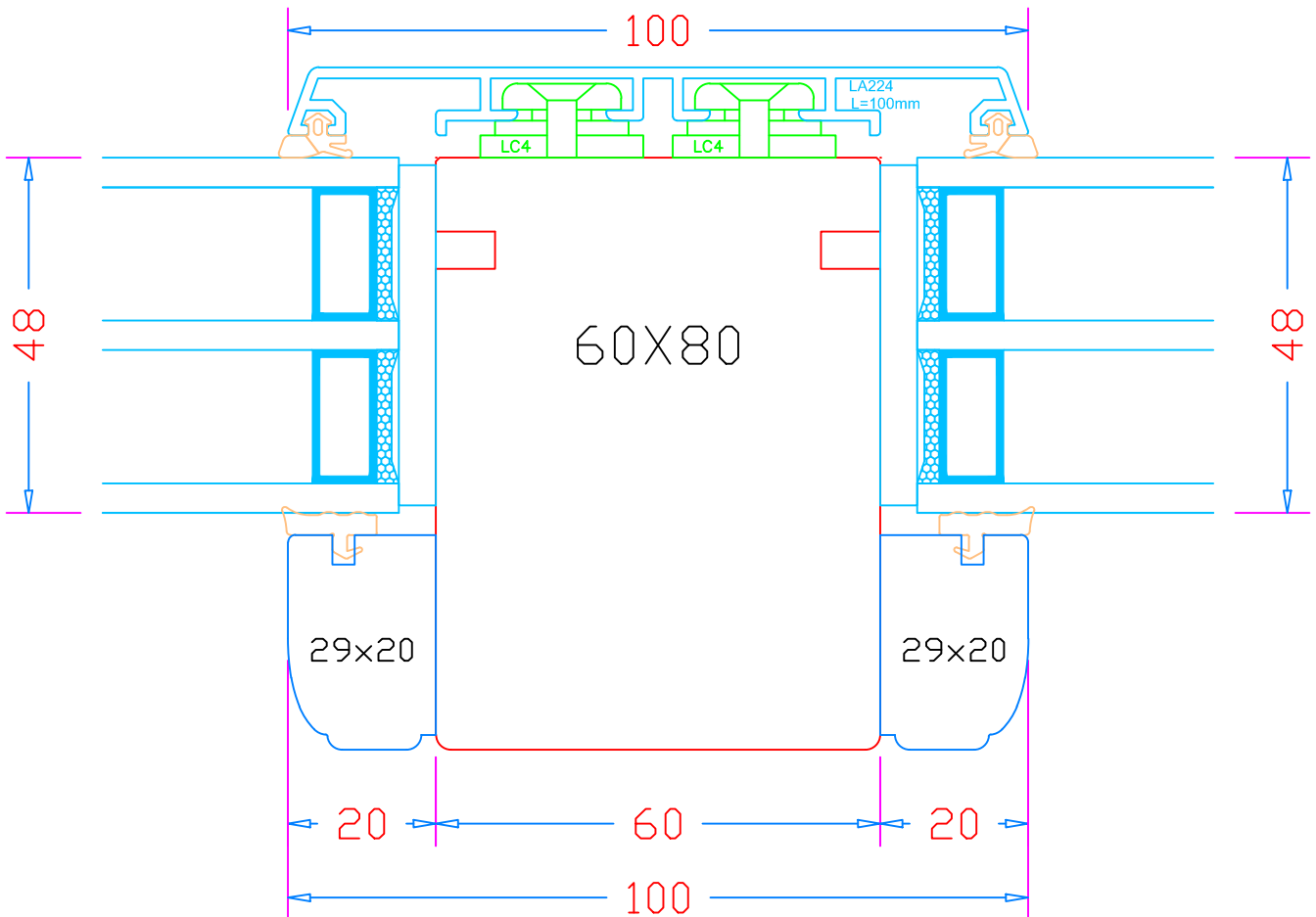
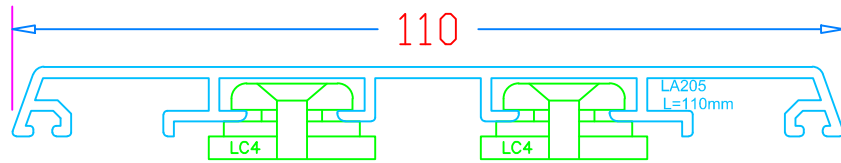
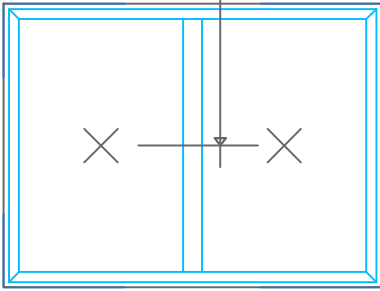

Coupe 14a
Vue intérieure

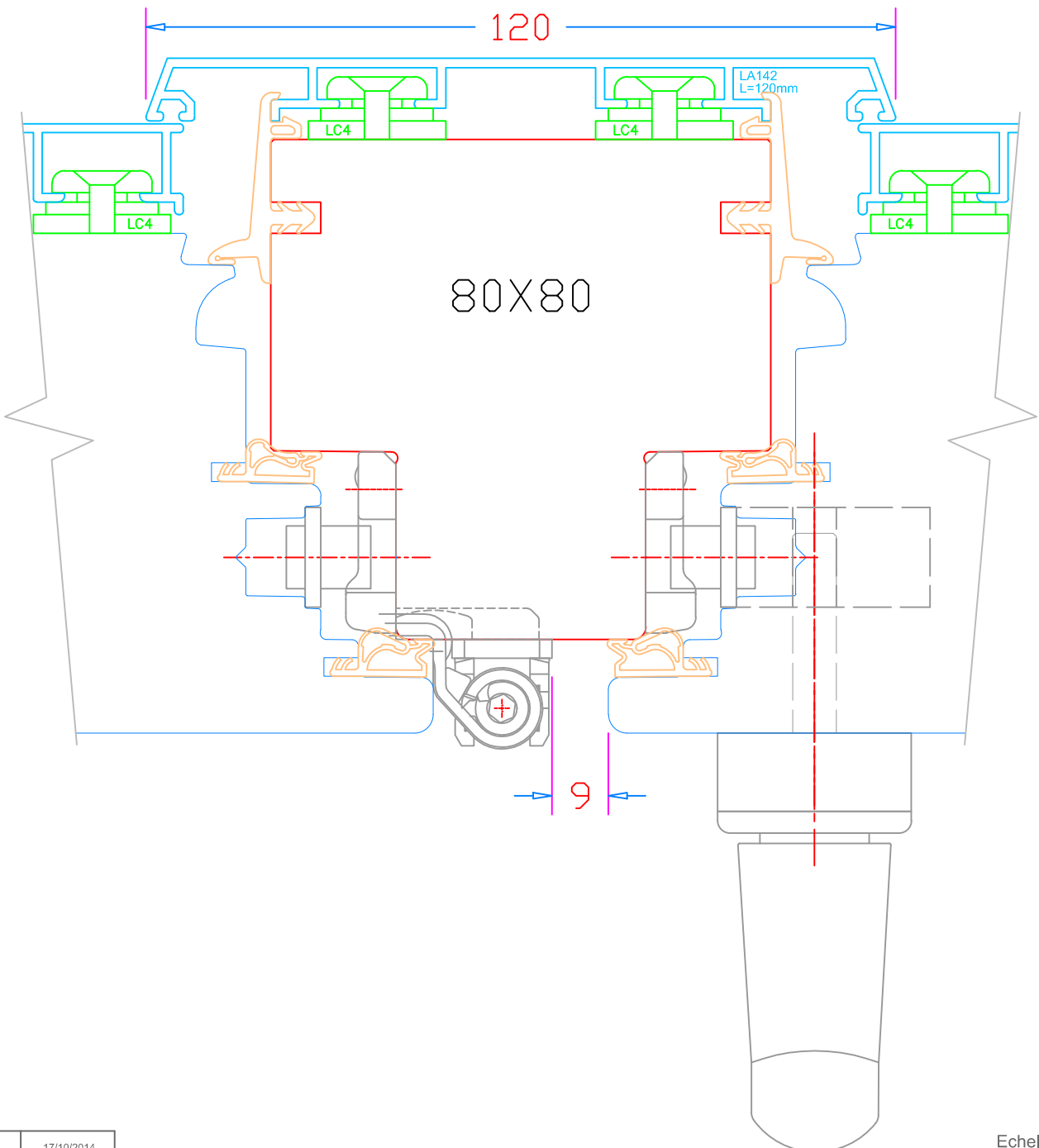
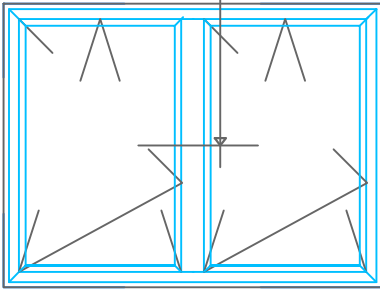

Coupe 14b
Vue intérieure

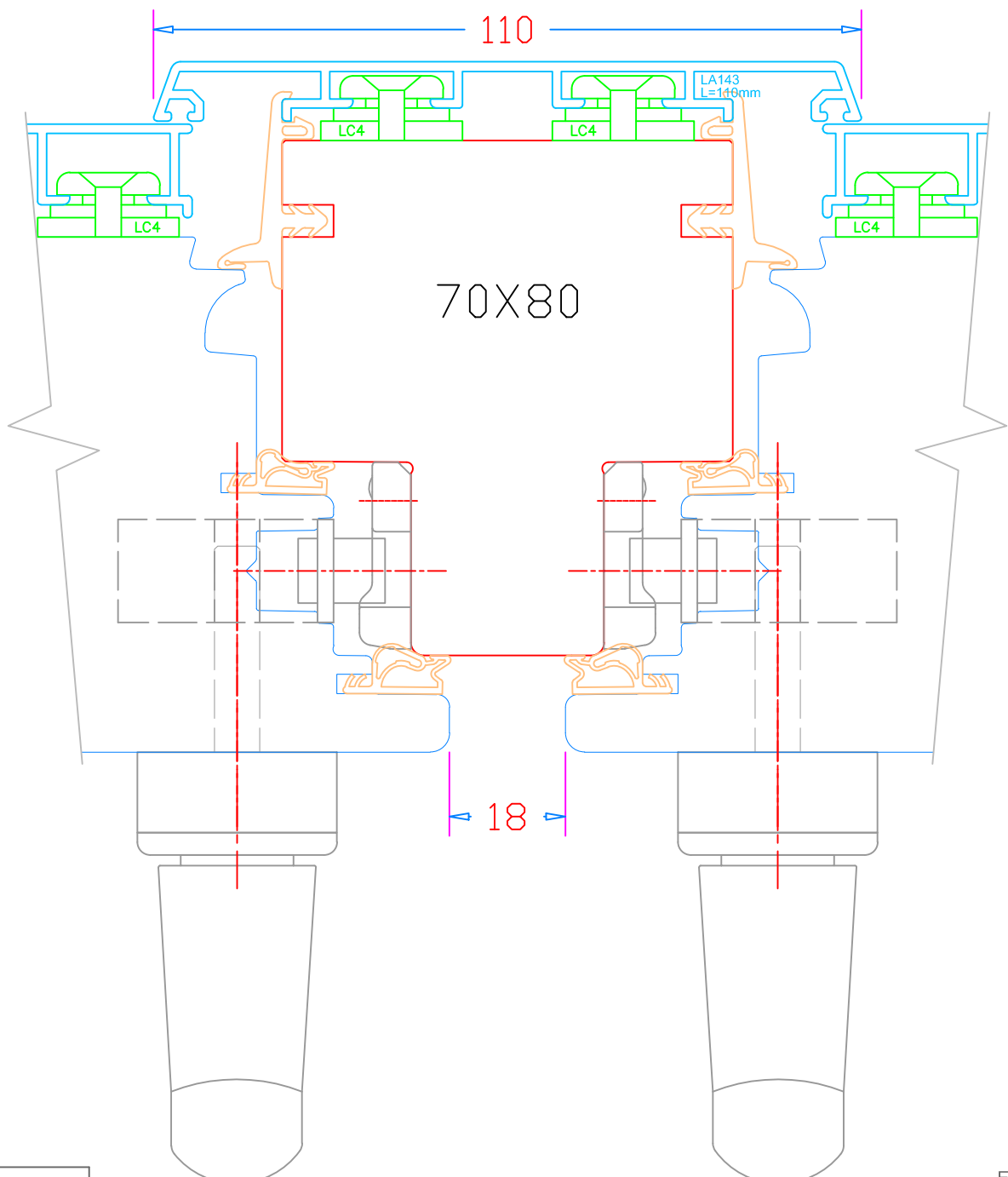
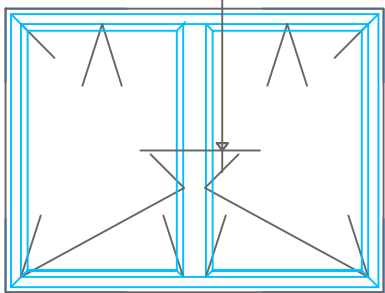

Date	17/10/2014
------	------------

Echelle : 1/1

Coupe 14c
Vue intérieure

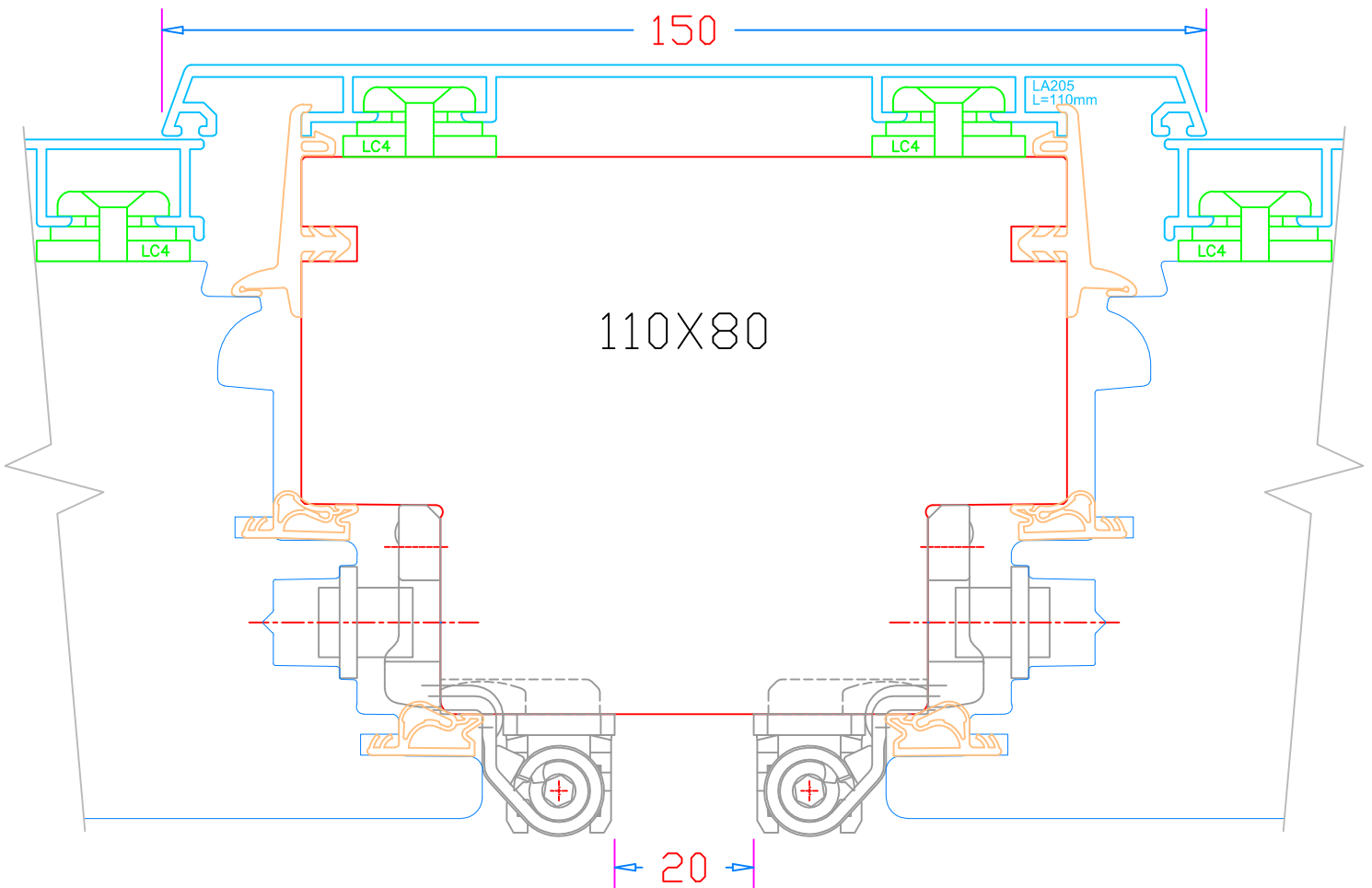
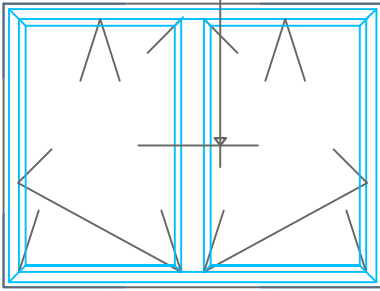

Coupe 15a
Vue intérieure

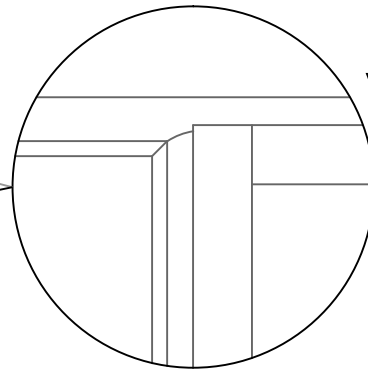
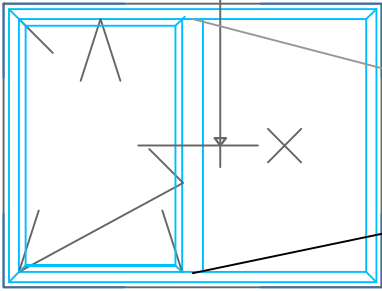

Vue intérieure
Assemblage du meneau

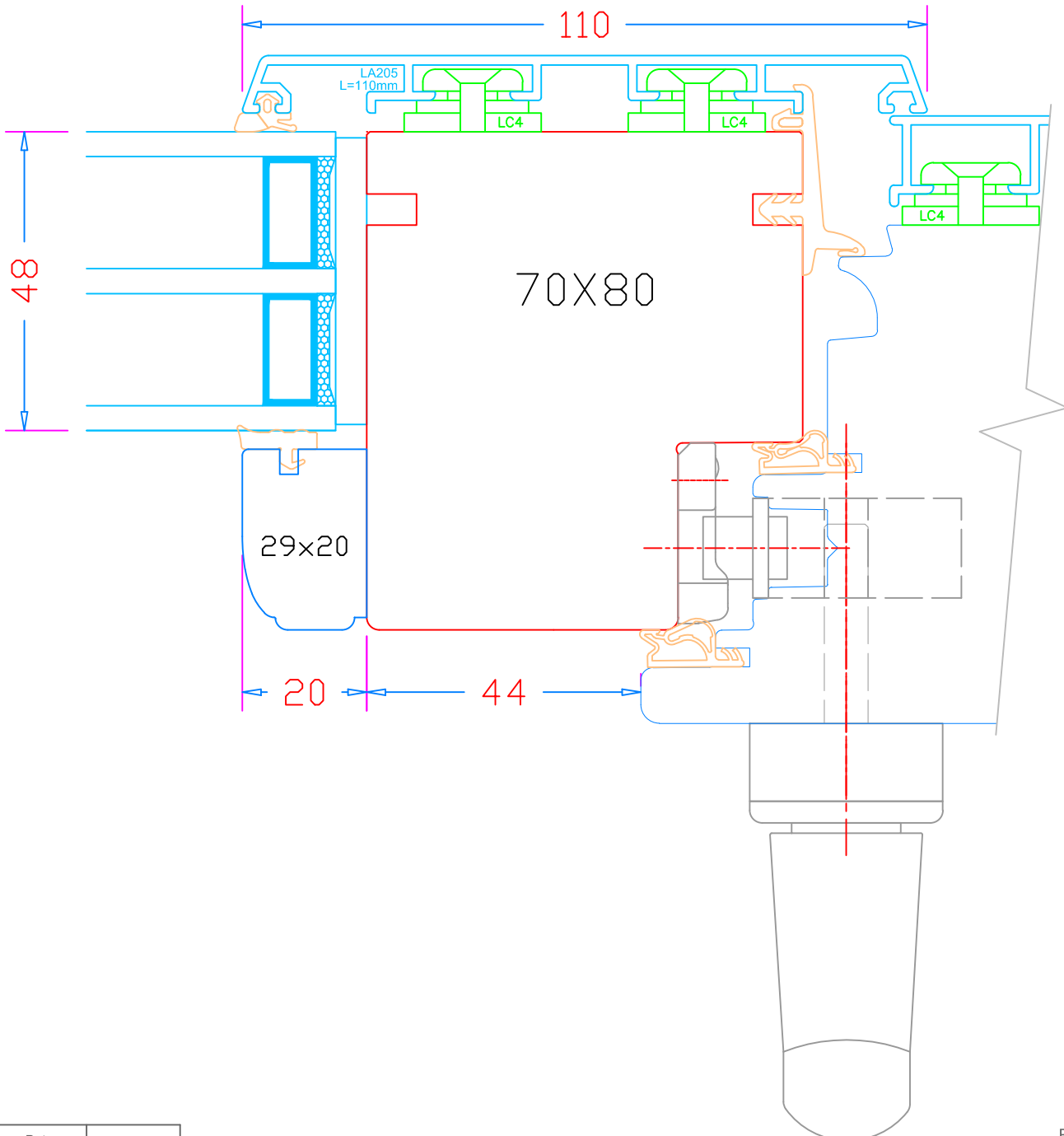

Coupe 15b
 Vue intérieure

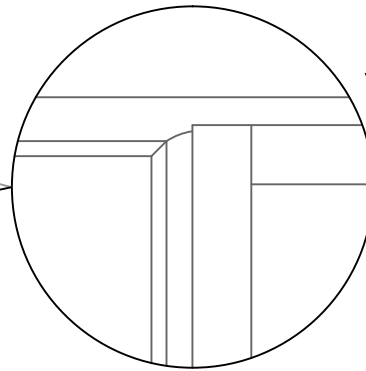
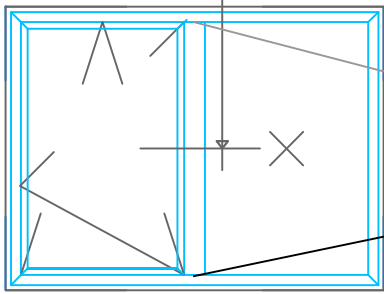

Vue intérieure
 Assemblage du meneau

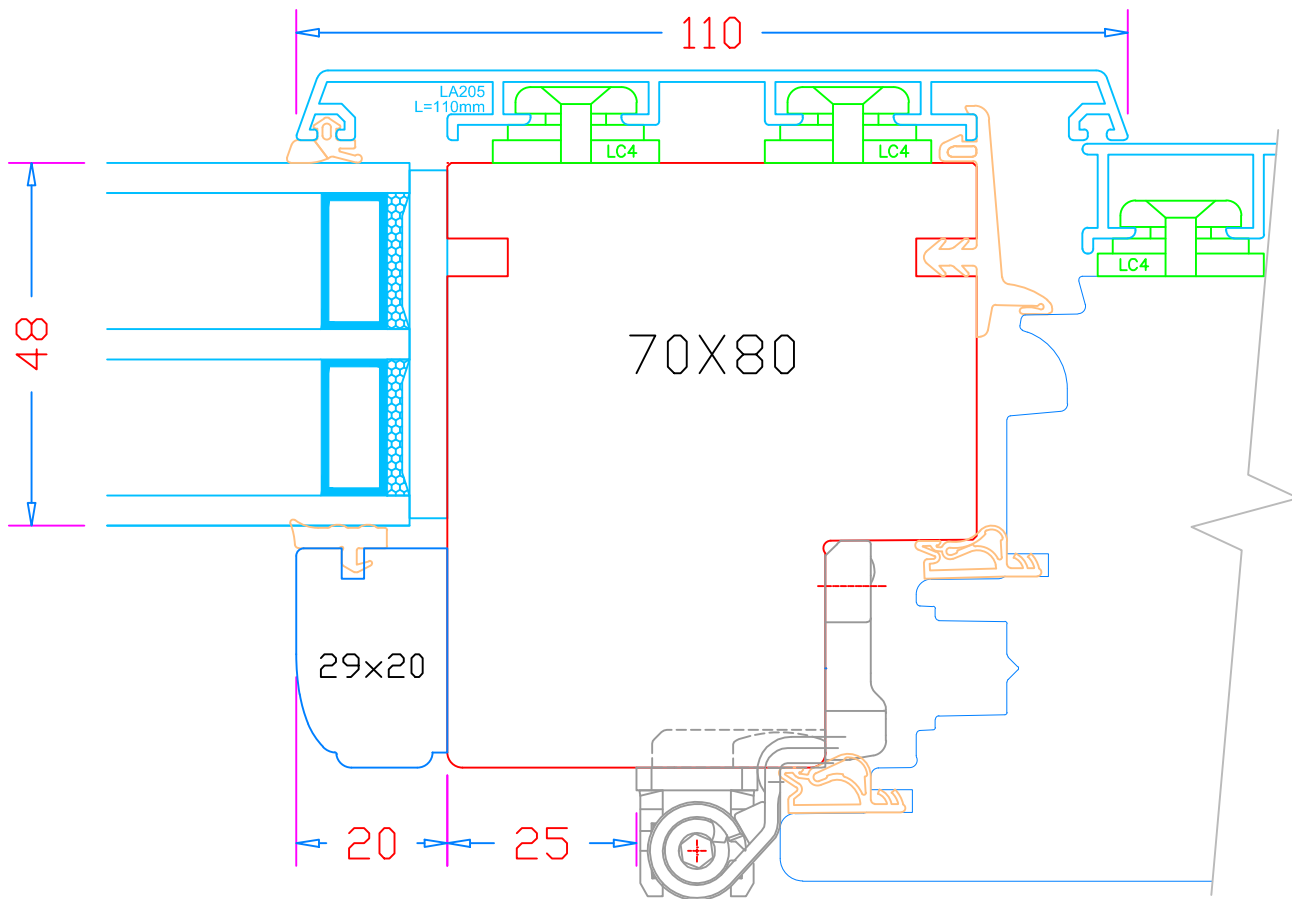

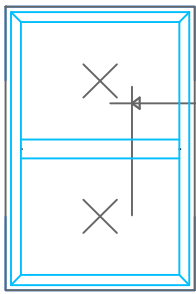

Coupe 16

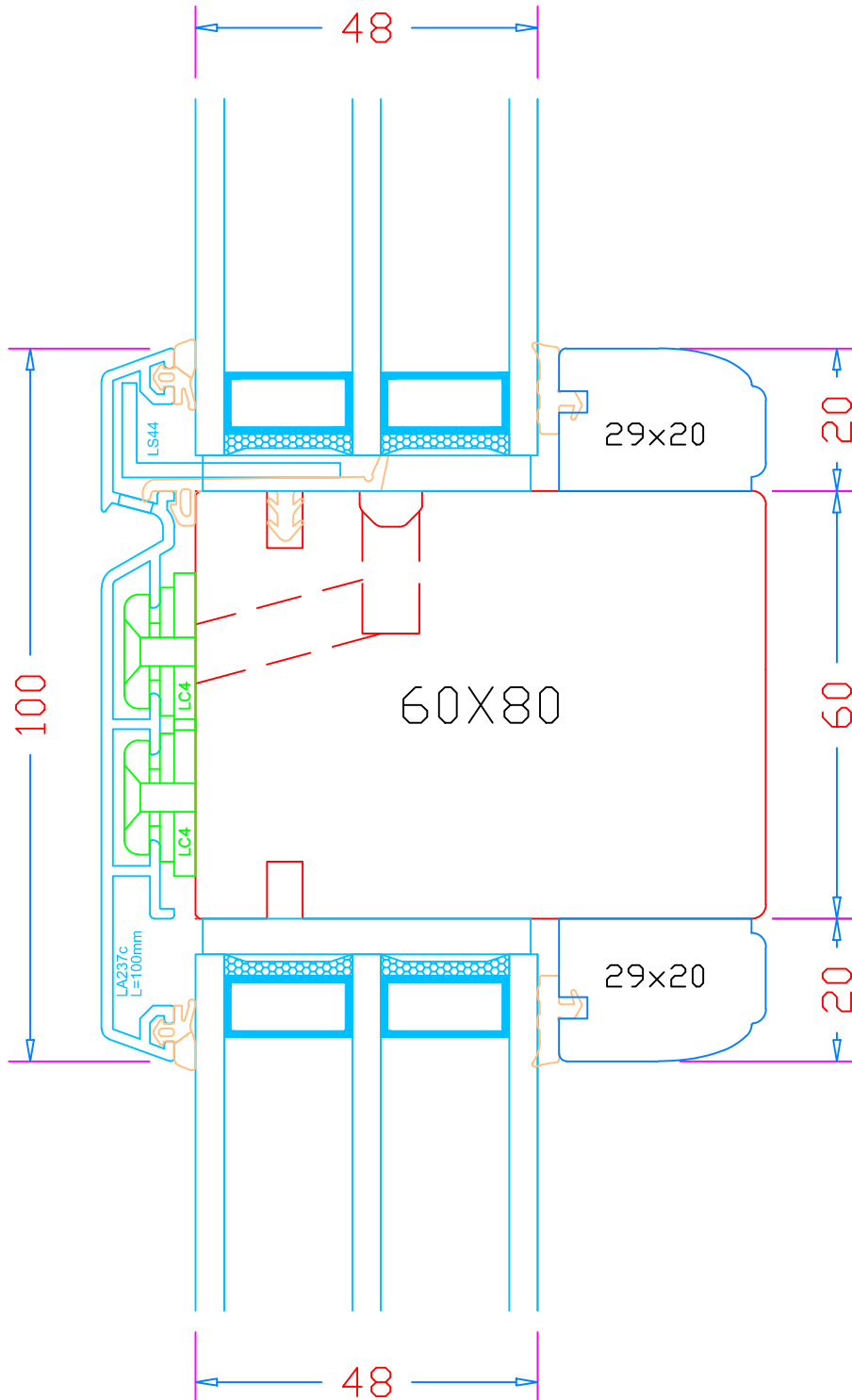

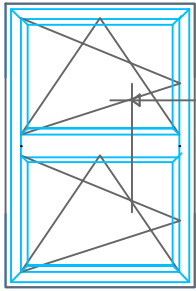

Coupe 17a

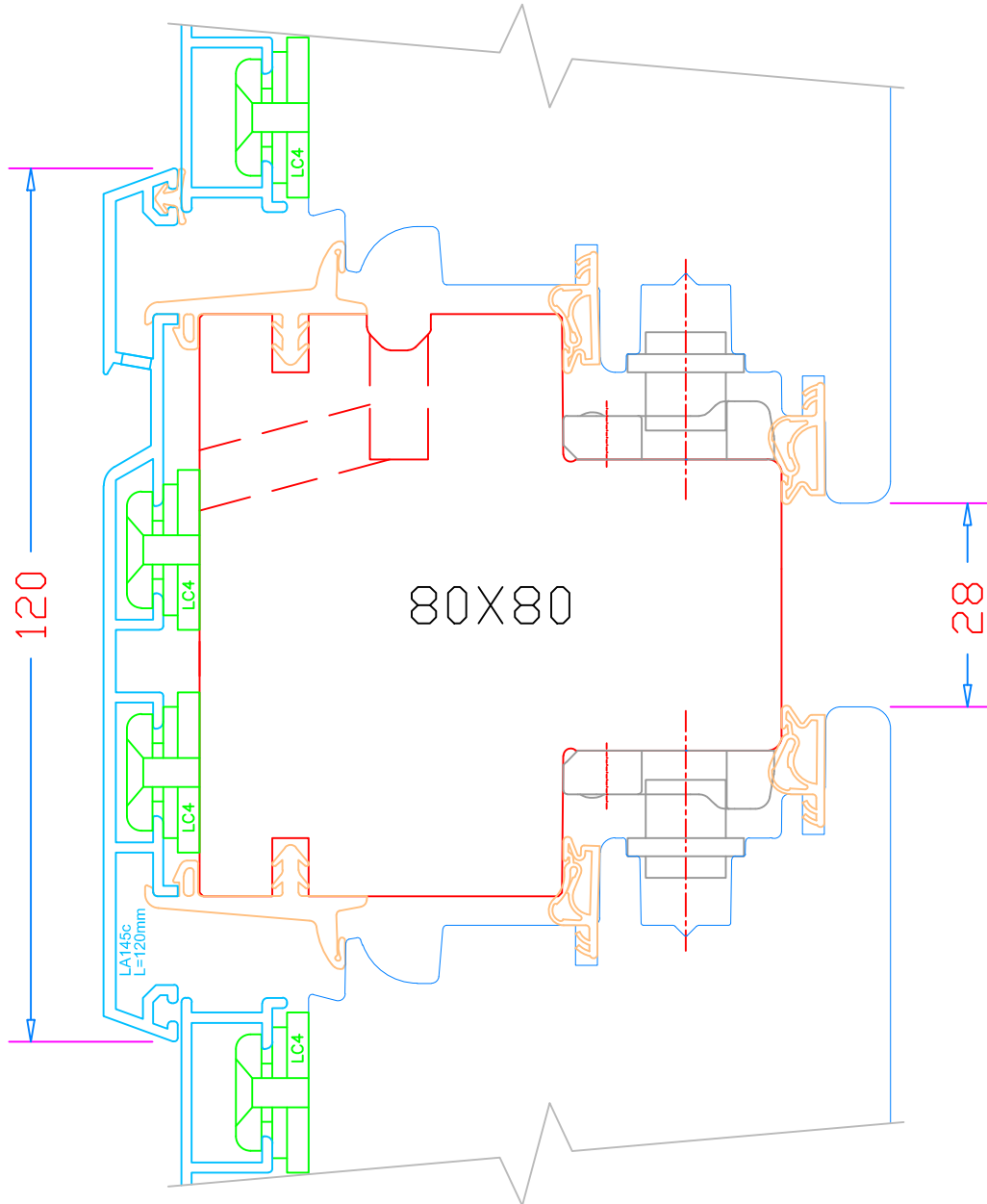

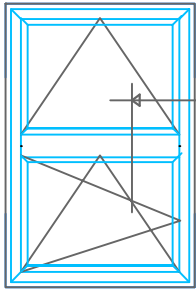

Coupe 17b

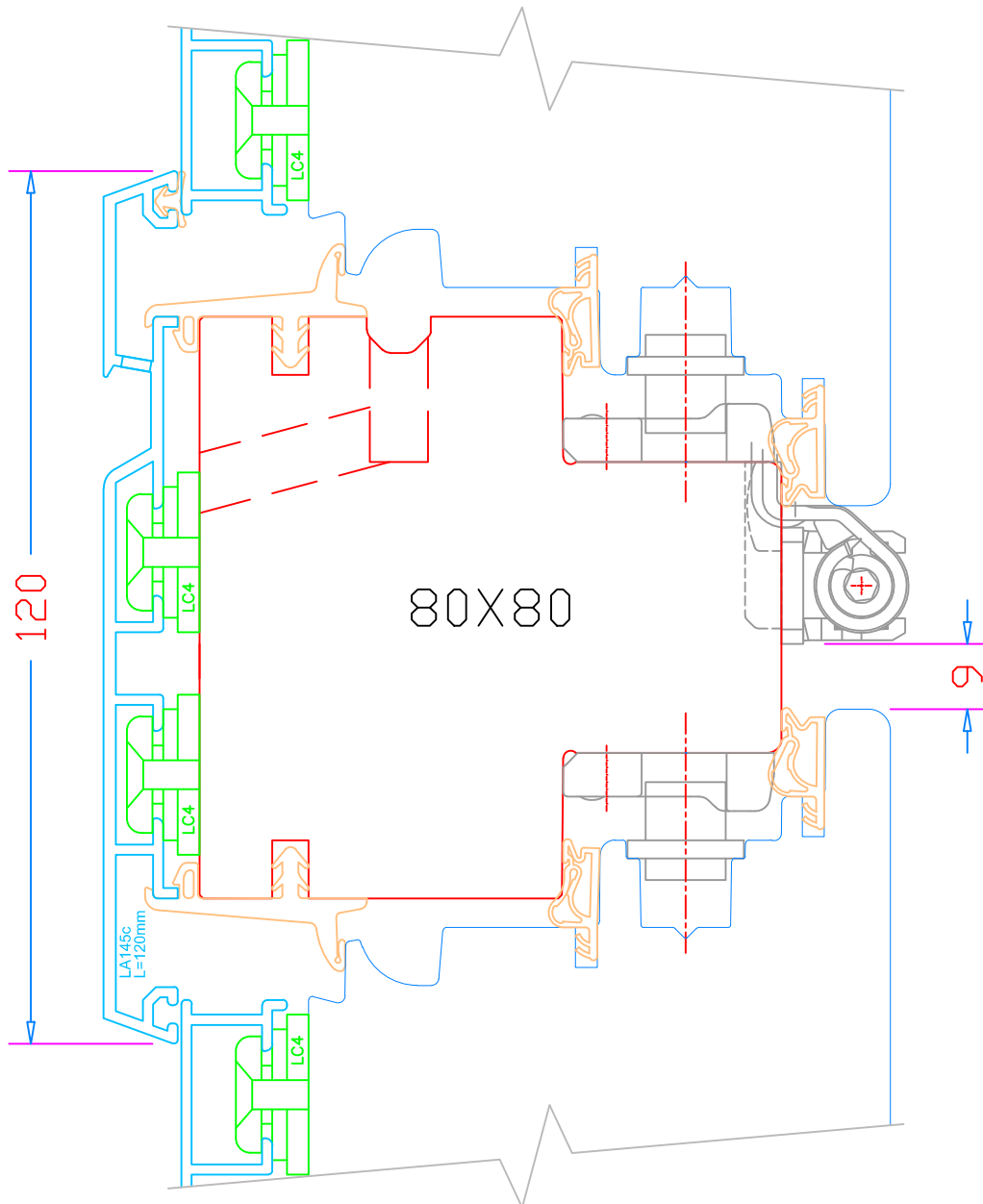

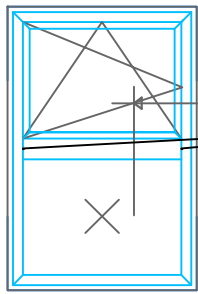

Coupe 18a

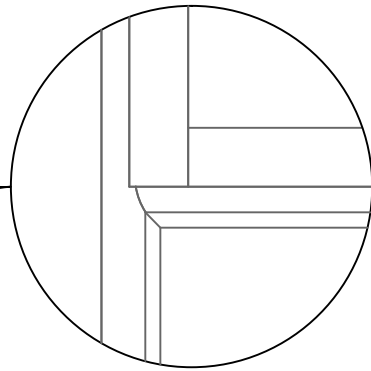

Vue intérieure

Assemblage de la traverse intermédiaire

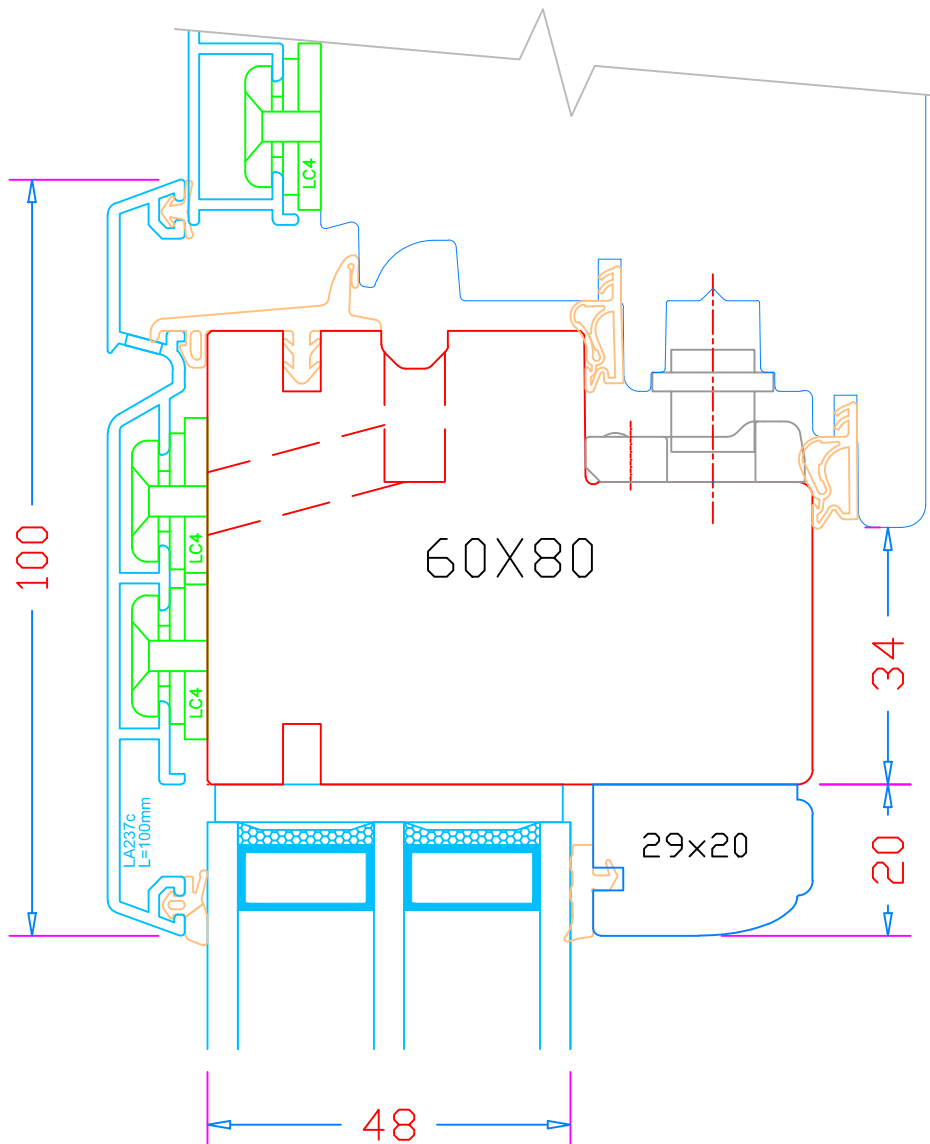

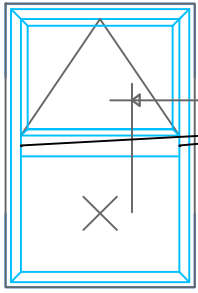

Coupe 18b

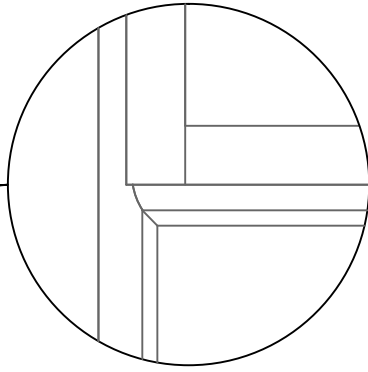

Vue intérieure

Assemblage de la traverse intermédiaire

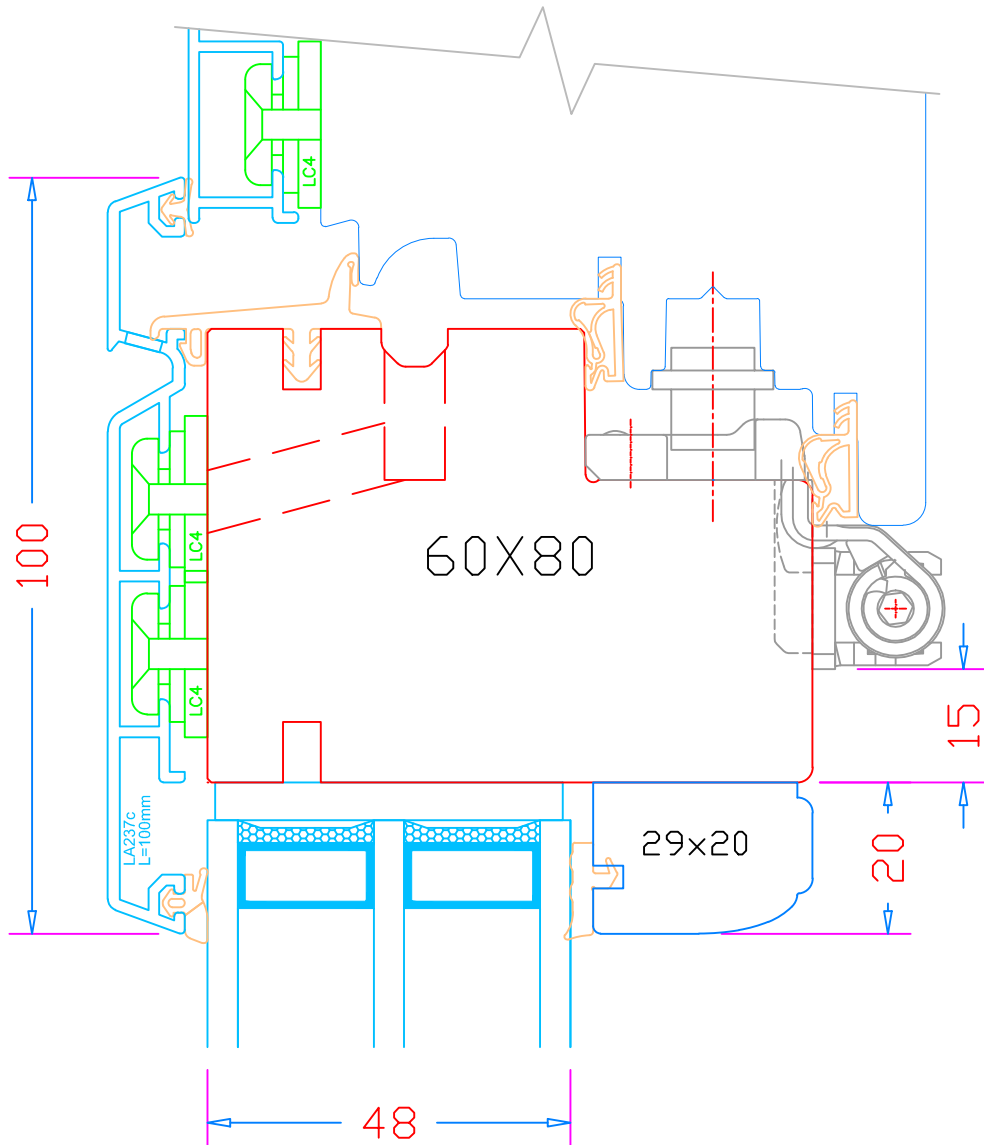

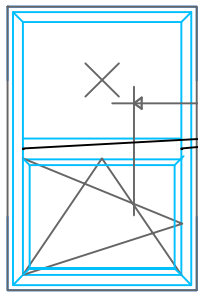

Coupe 19

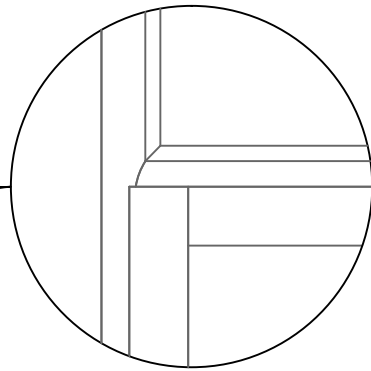

Vue intérieure

Assemblage de la traverse intermédiaire

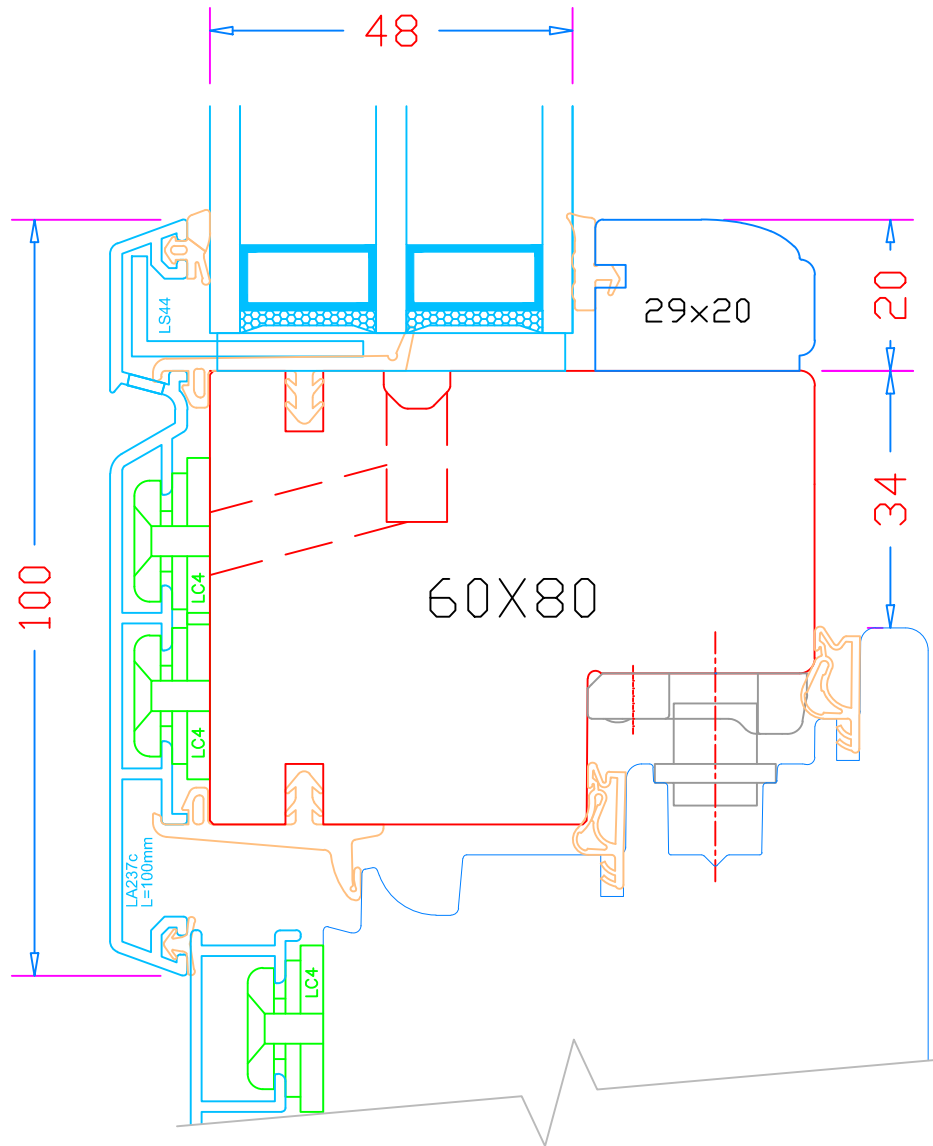

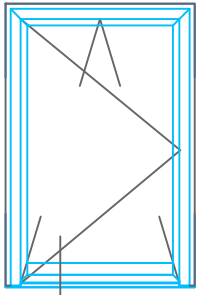

Coupe 20a

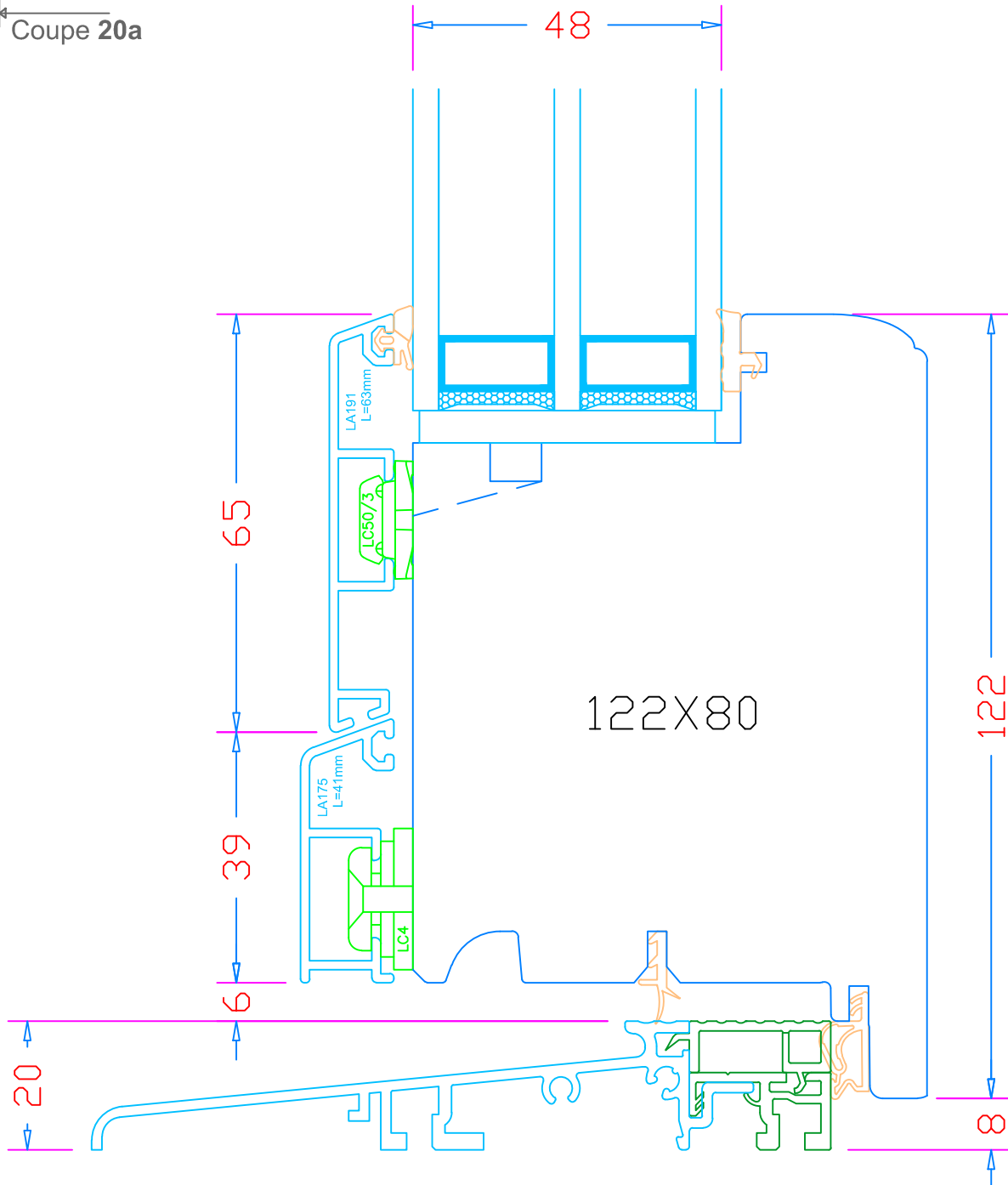

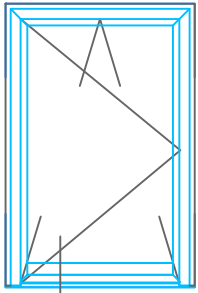

Coupe 20b

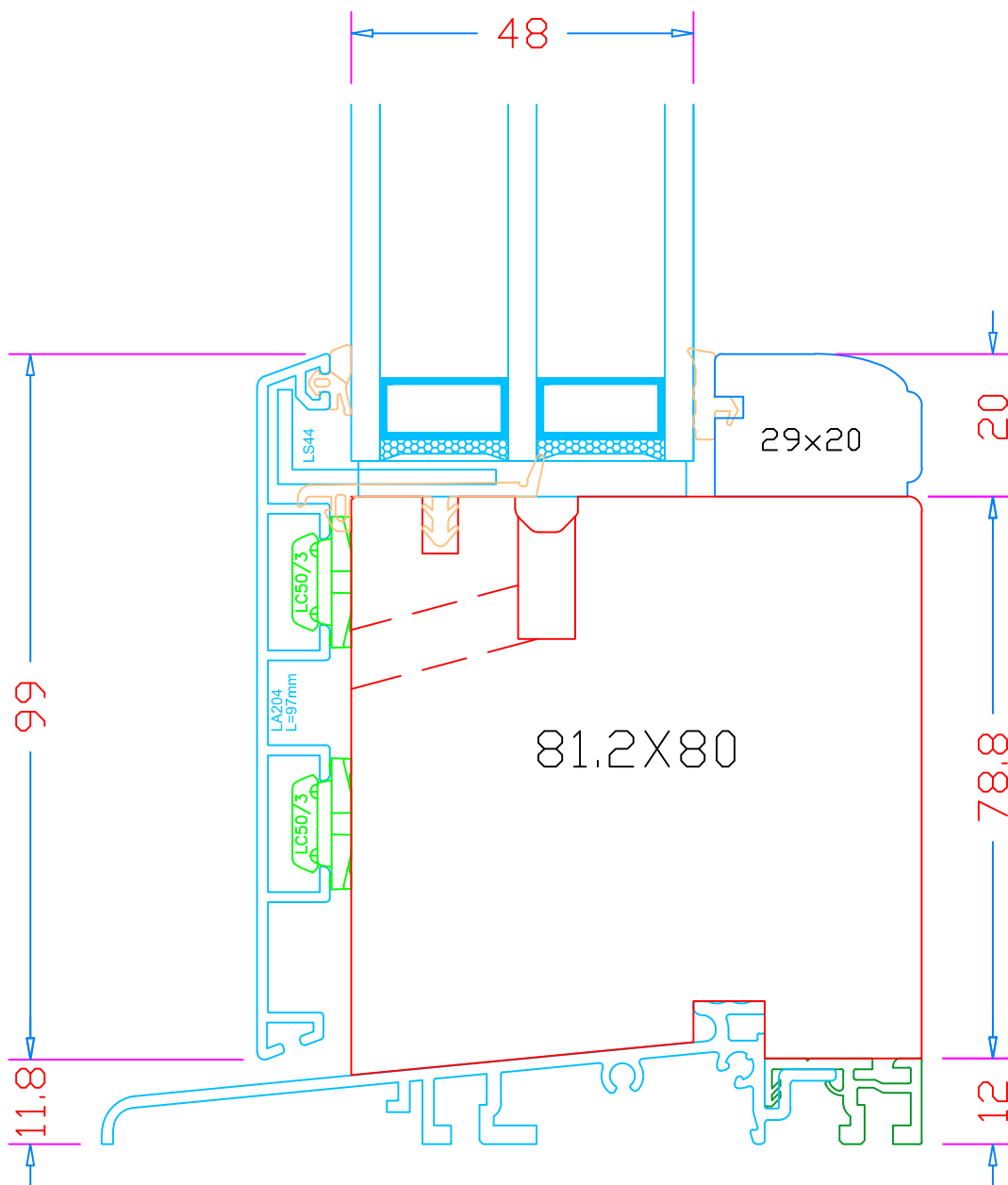

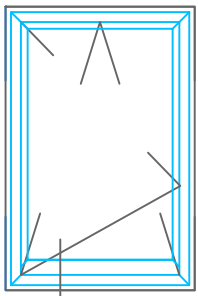

Coupe 21

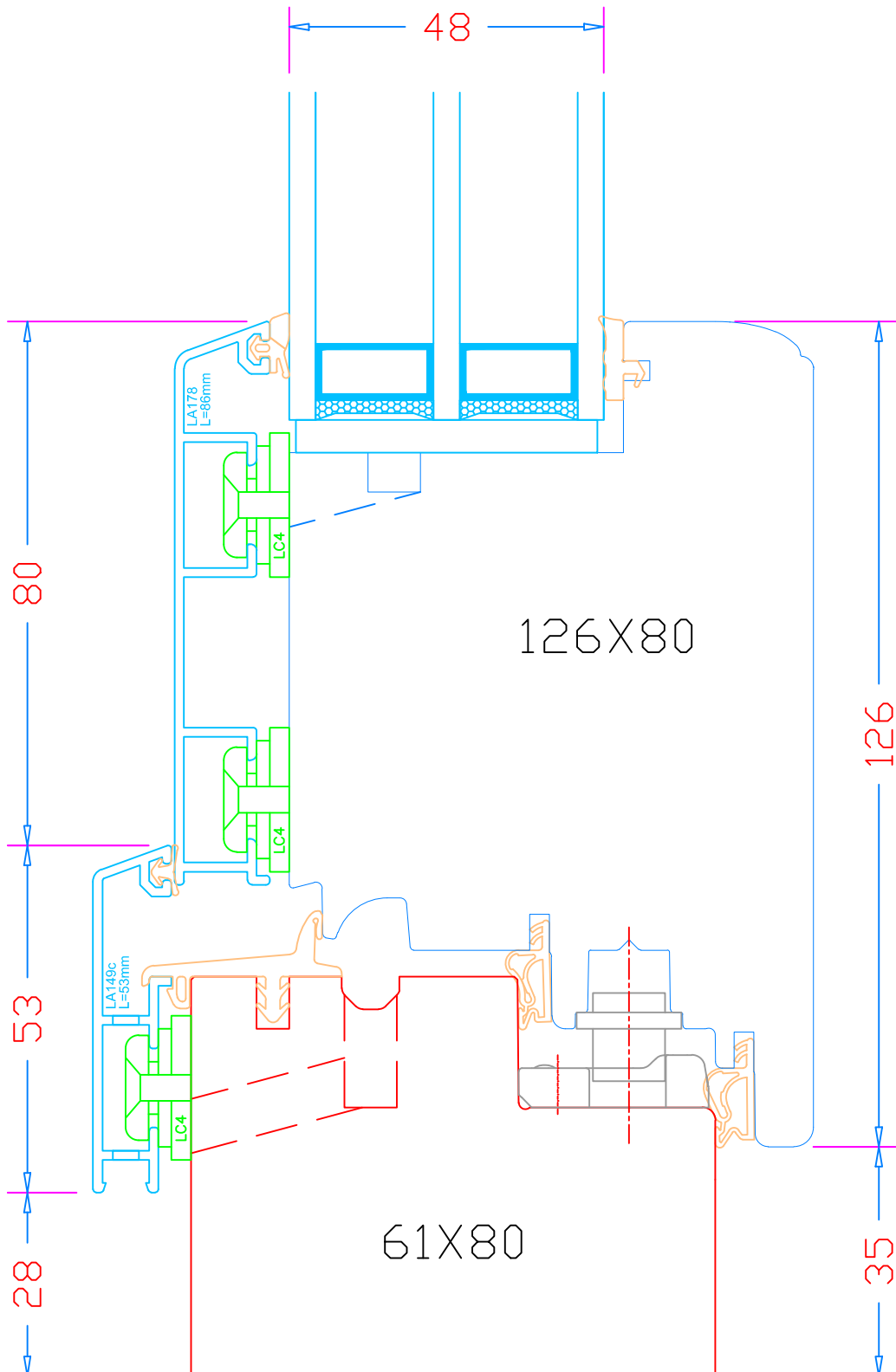

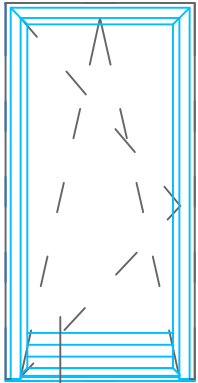

Coupe 22a

UNIQUEMENT

Porte balcon 1 vantail.

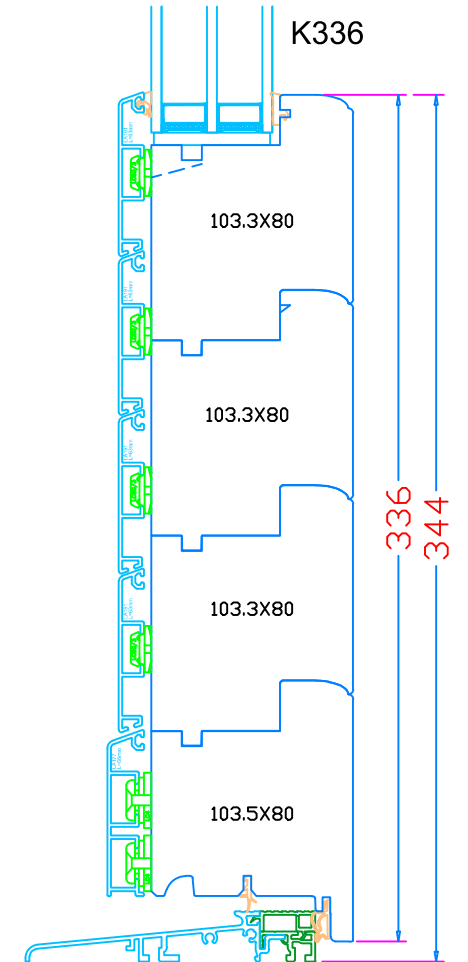
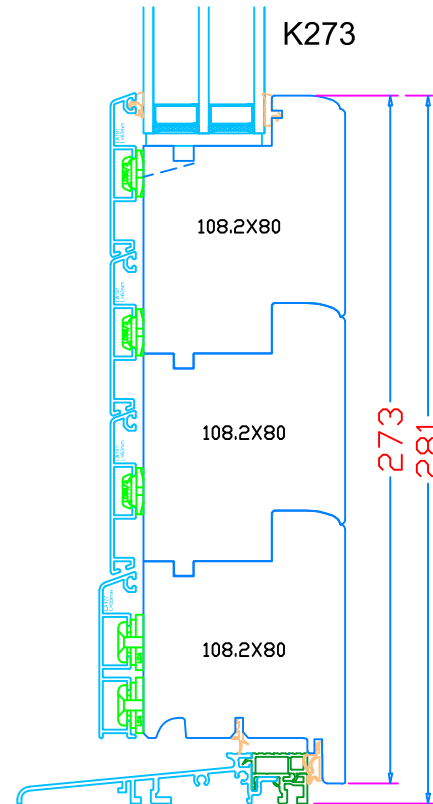
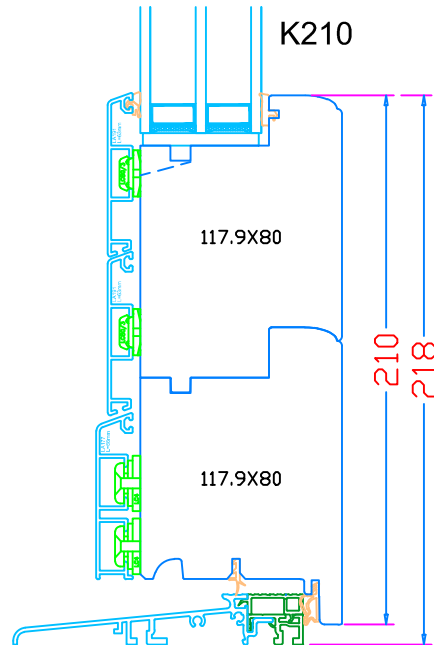
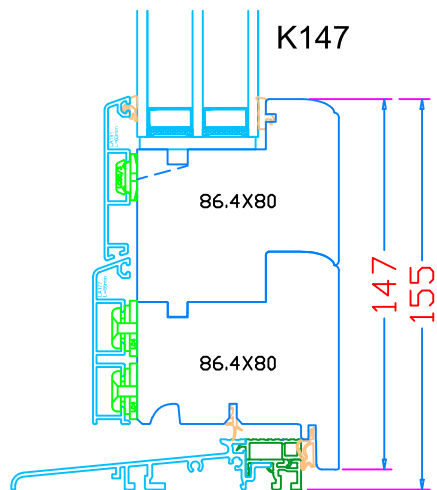

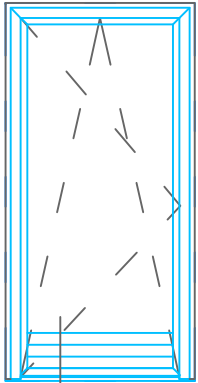

Coupe 22b

UNIQUEMENT

Porte fenêtre 1 et 2 vantaux
Porte balcon 2 vantaux

K122 : Impossible si meneau sur traverse basse.
Prendre K185

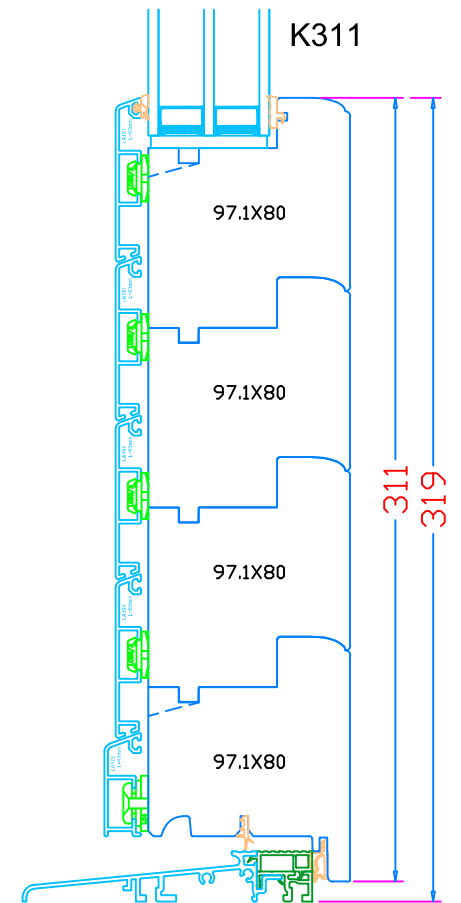
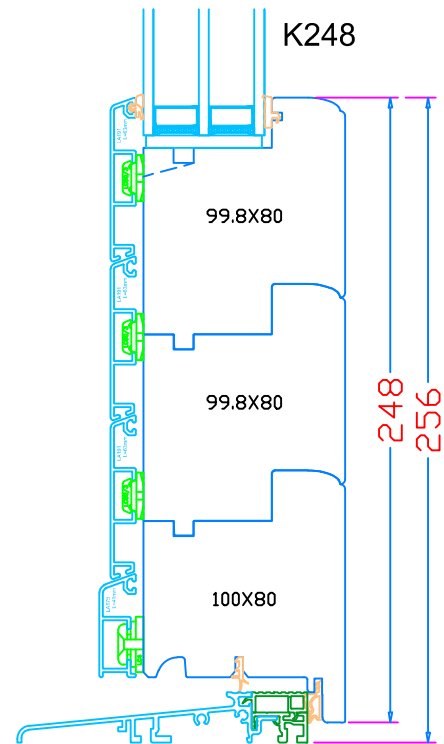
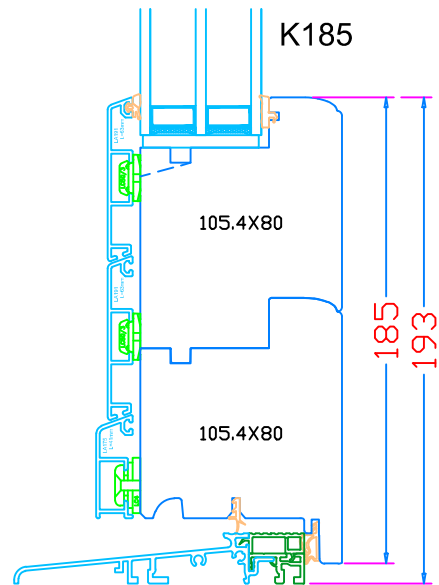
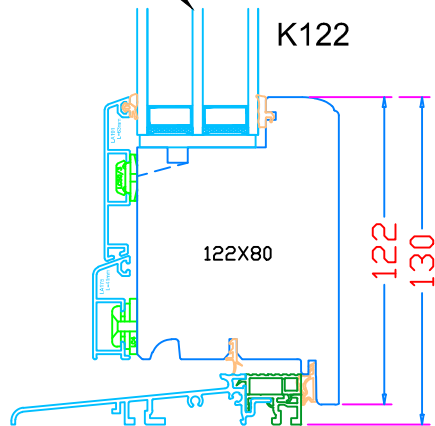

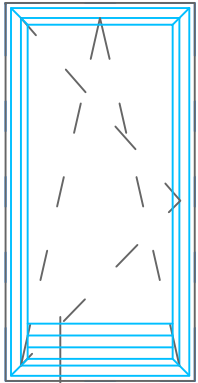

Coupe 23a

UNIQUEMENT

Porte balcon 1 vantail.

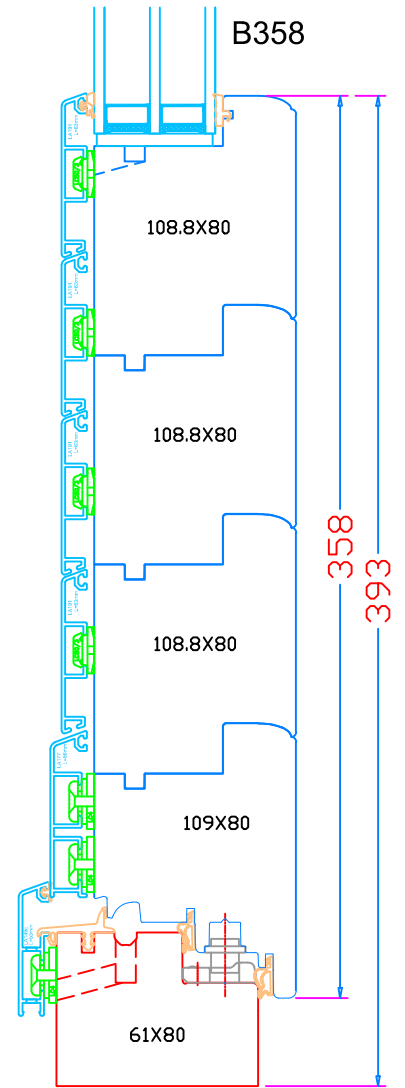
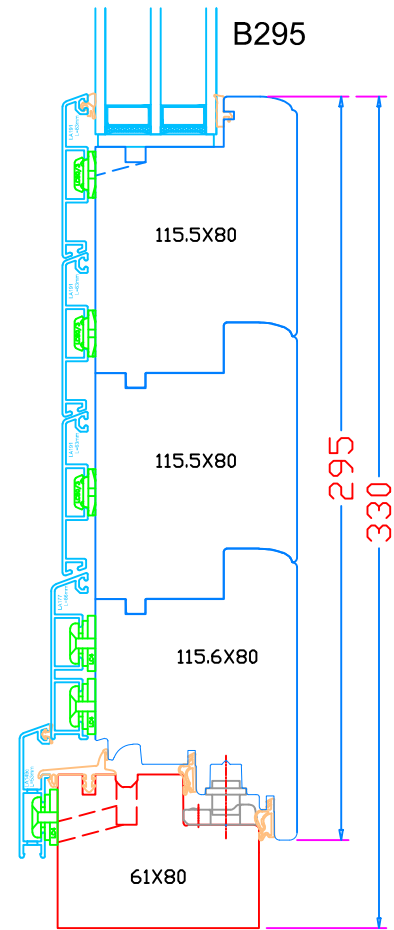
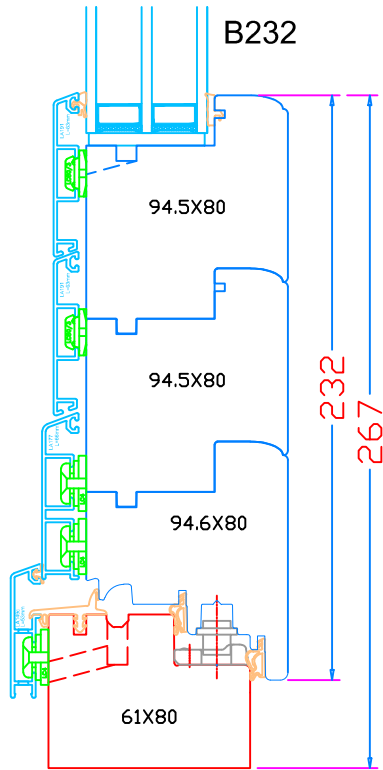
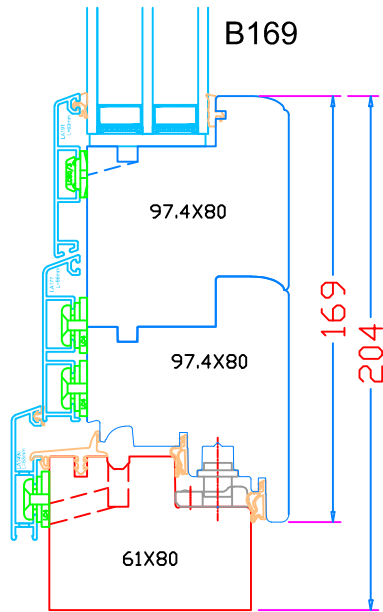

Date	17/10/2014
------	------------

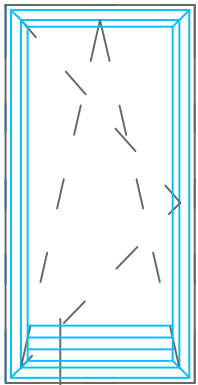

Coupe 23b

UNIQUEMENT

Porte fenêtre 1 et 2 vantaux
Porte balcon 2 vantaux

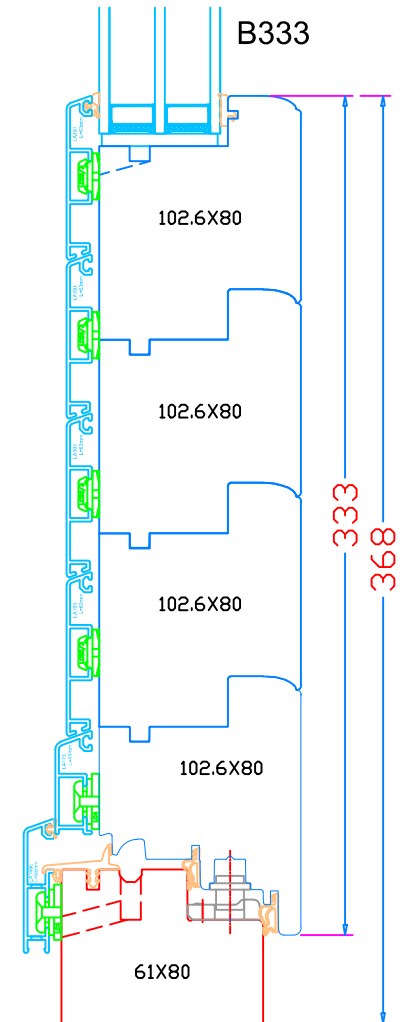
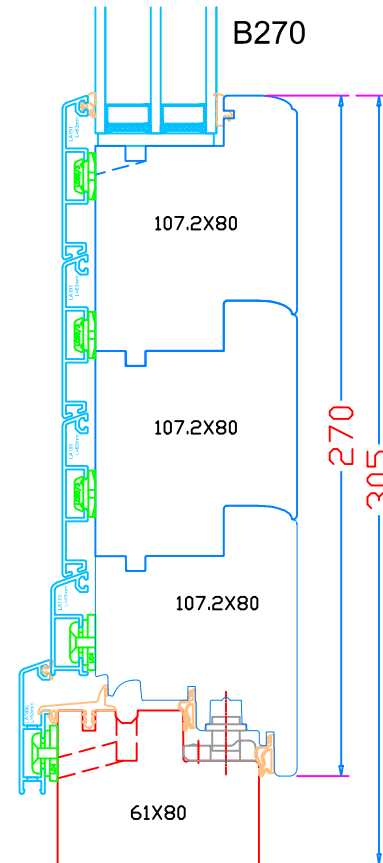
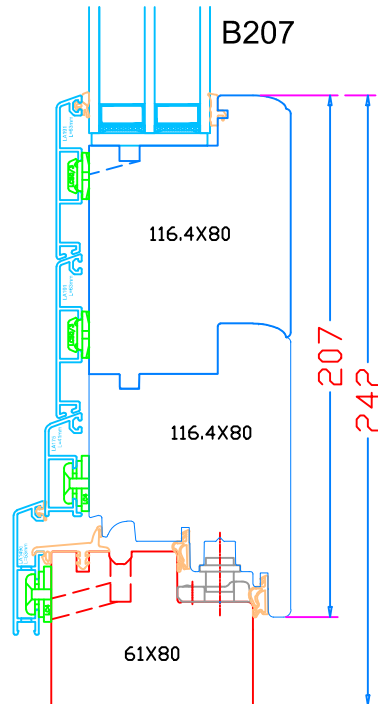
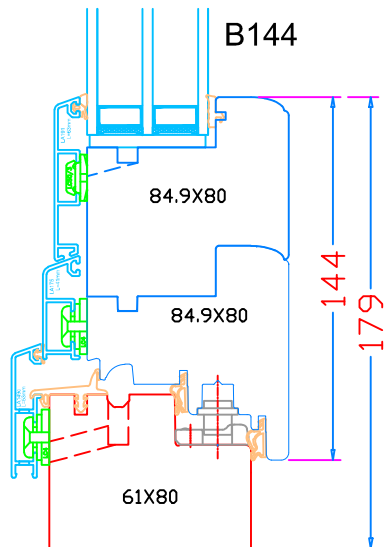

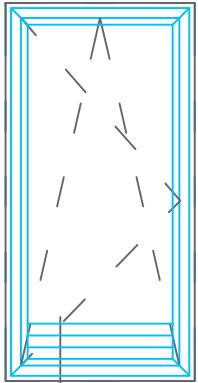

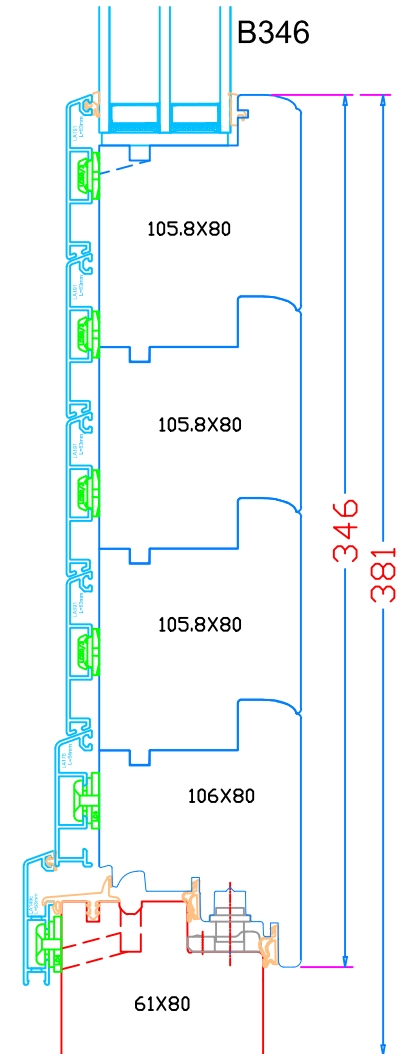
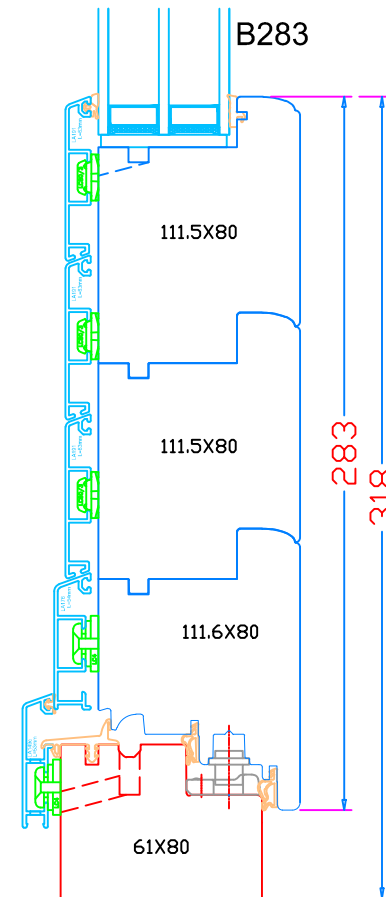
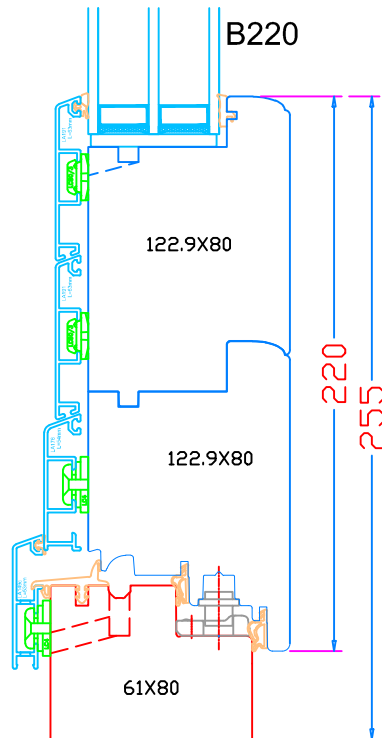
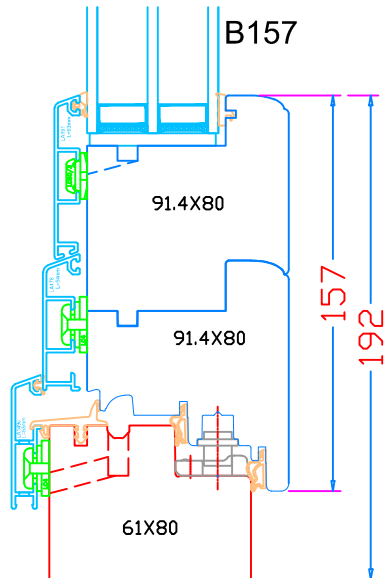
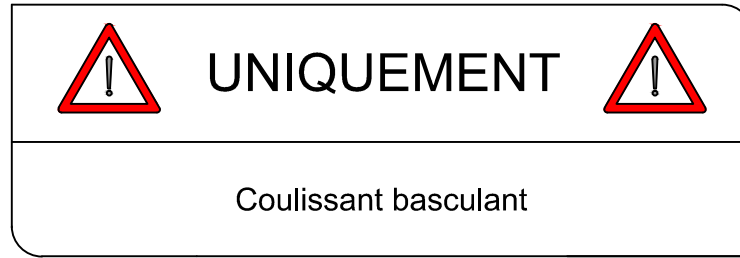

Coupe 23c

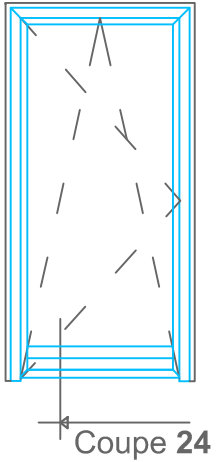



 **UNIQUEMENT** 

Porte fenêtre 1 et 2 vantaux.
Porte balcon 1 et 2 vantaux.

S129 : Impossible si meneau
sur traverse basse.
Prendre S192

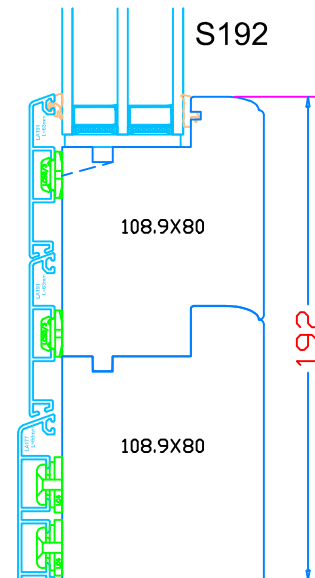
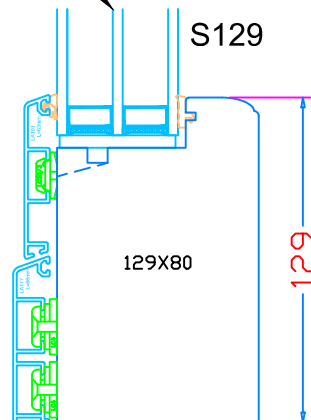

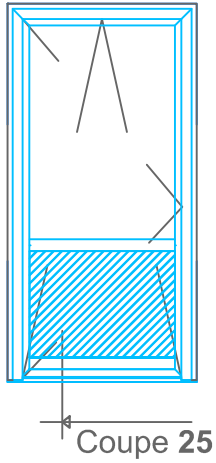

OPTION
 LISSE INTERIEUR

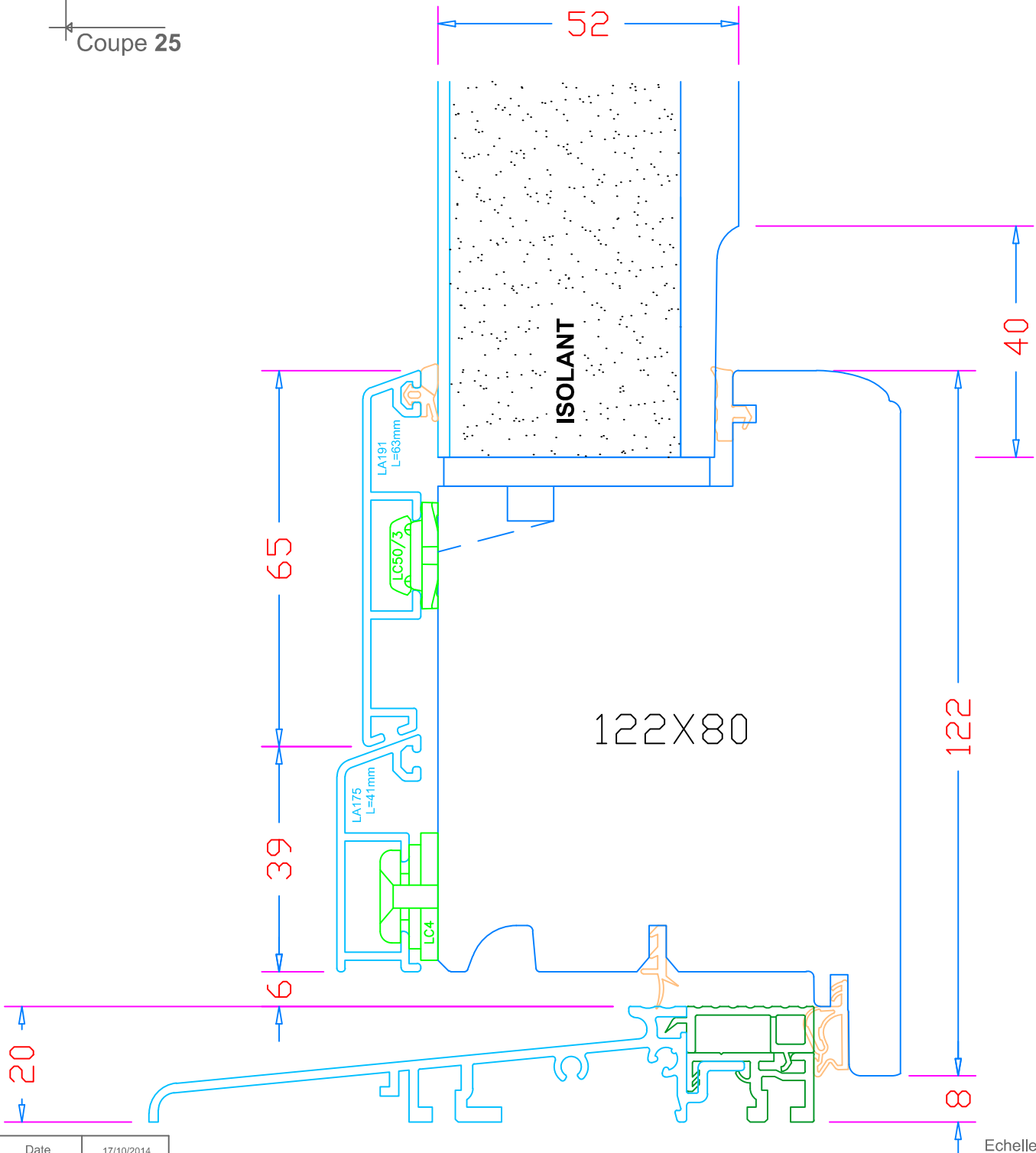
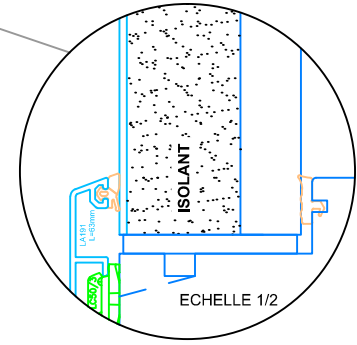

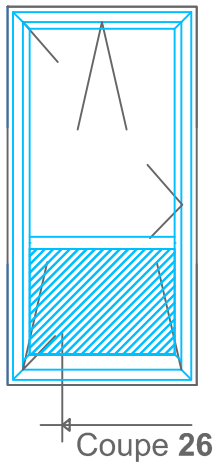

OPTION
 LISSE INTERIEUR

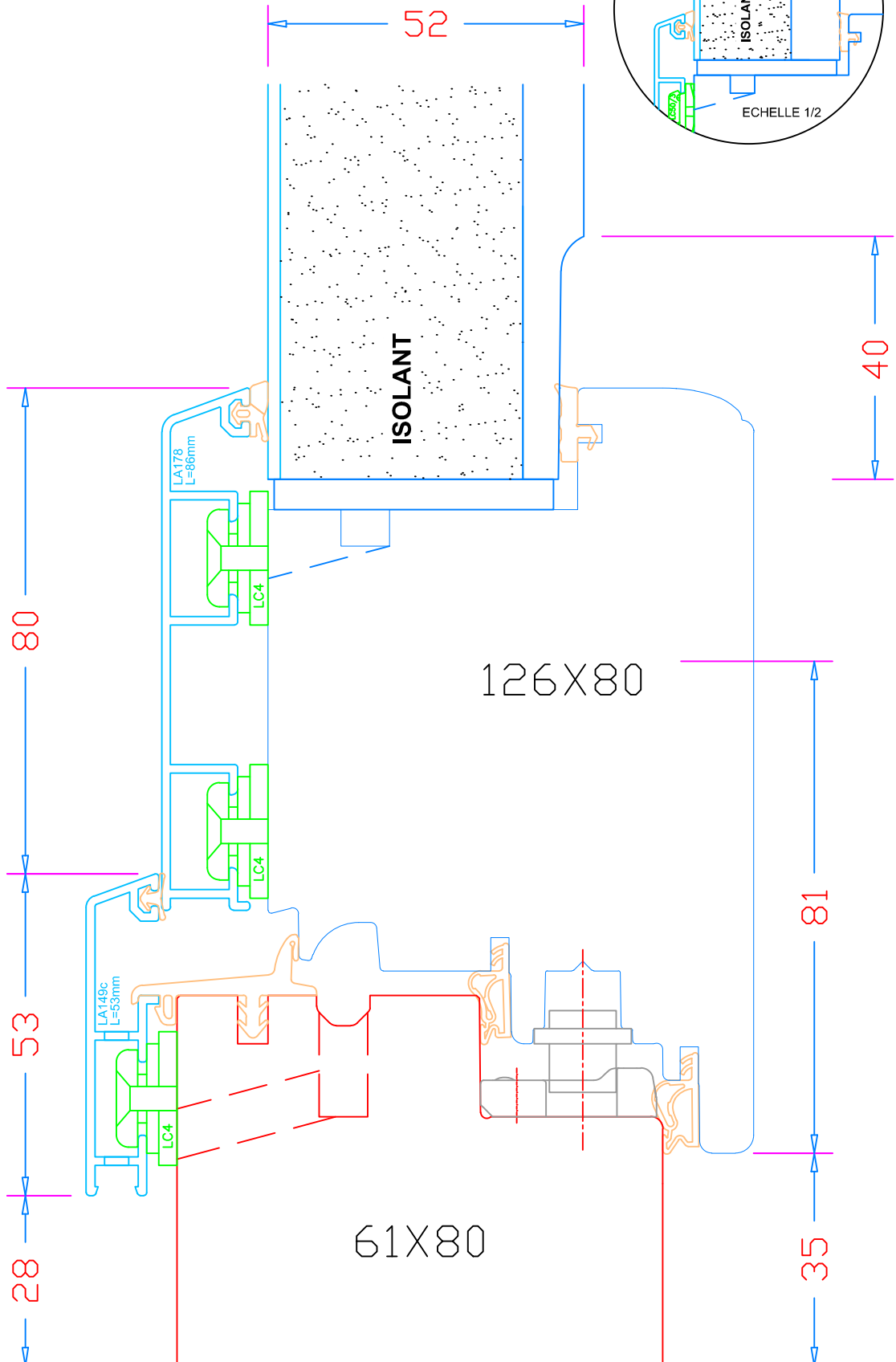
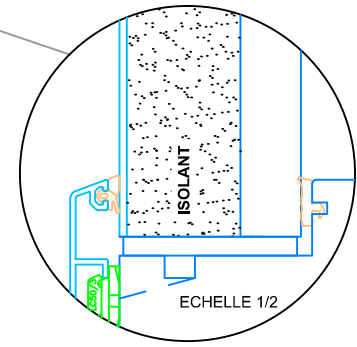

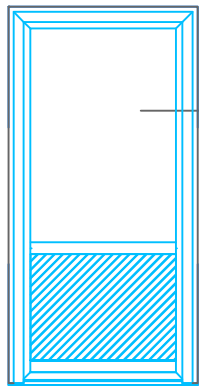

Coupe 27
 Vue intérieure

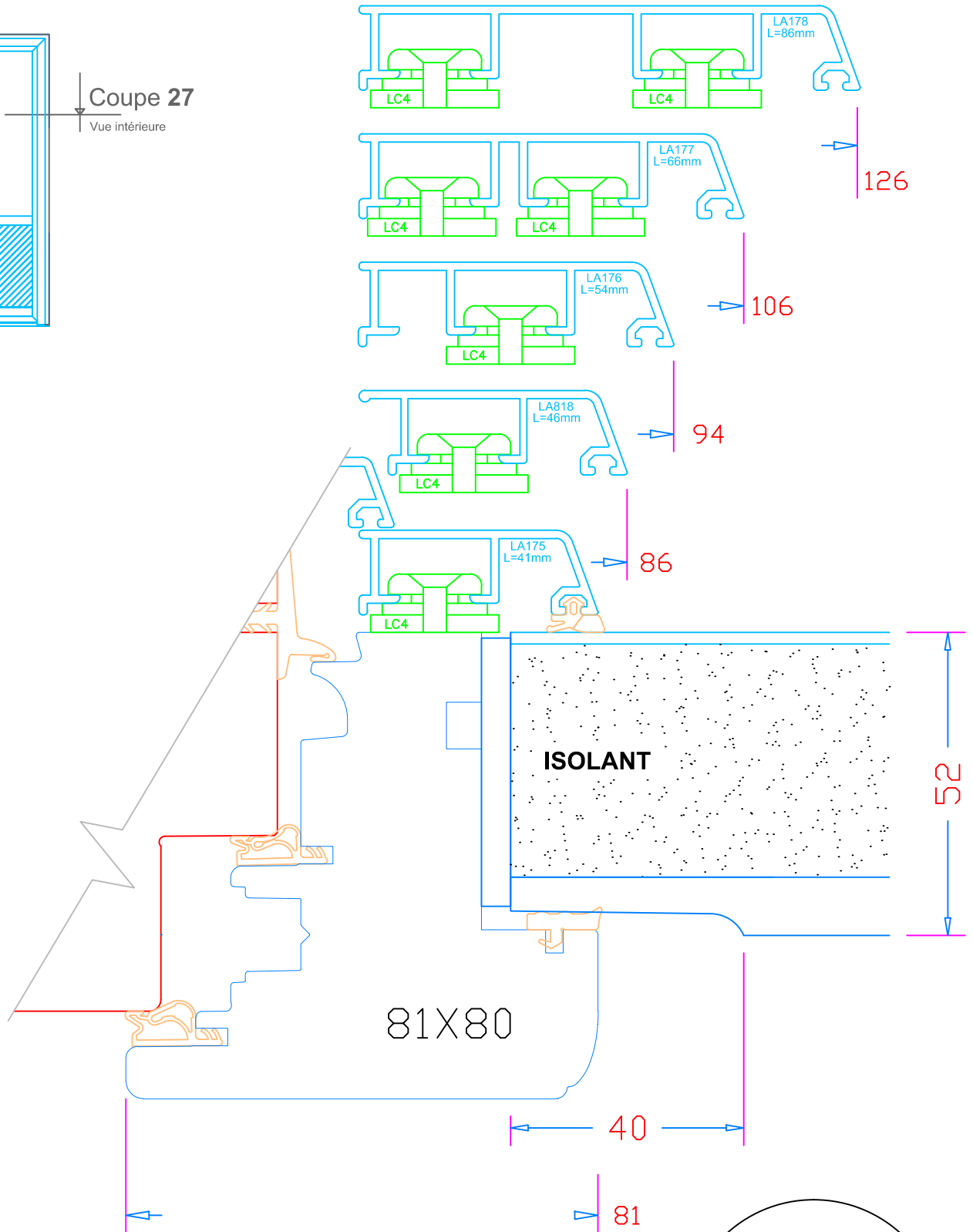

OPTION
 LISSE INTERIEUR

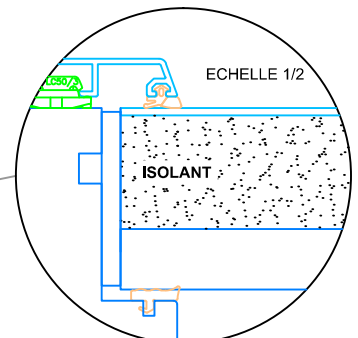

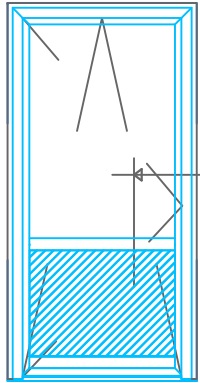

Coupe 28

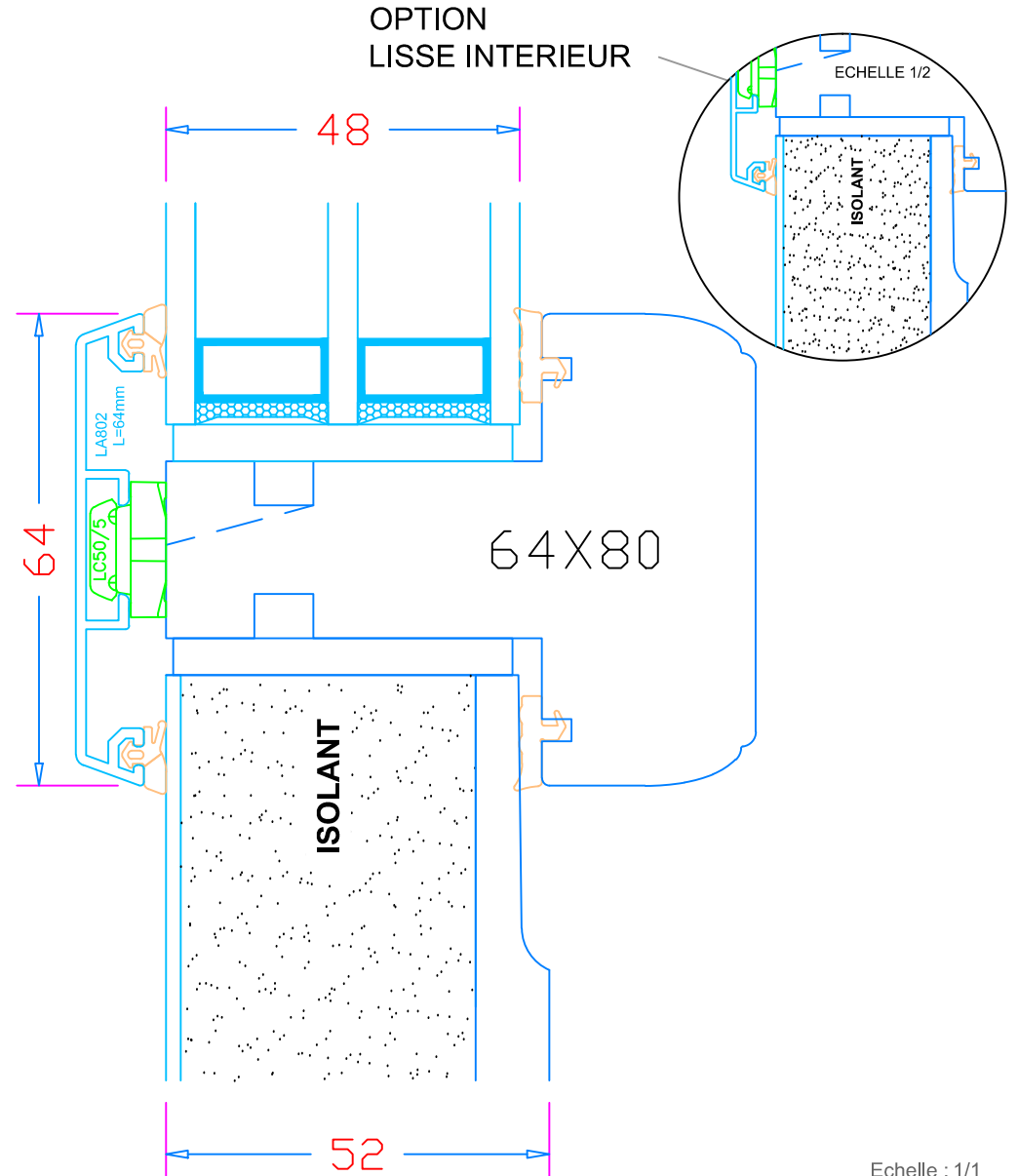
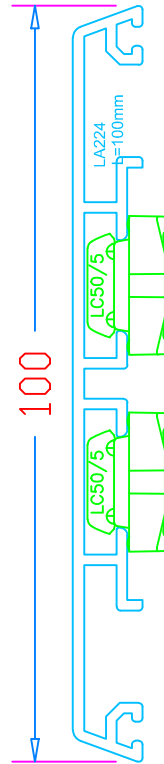
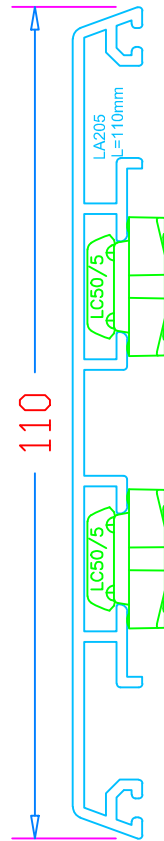

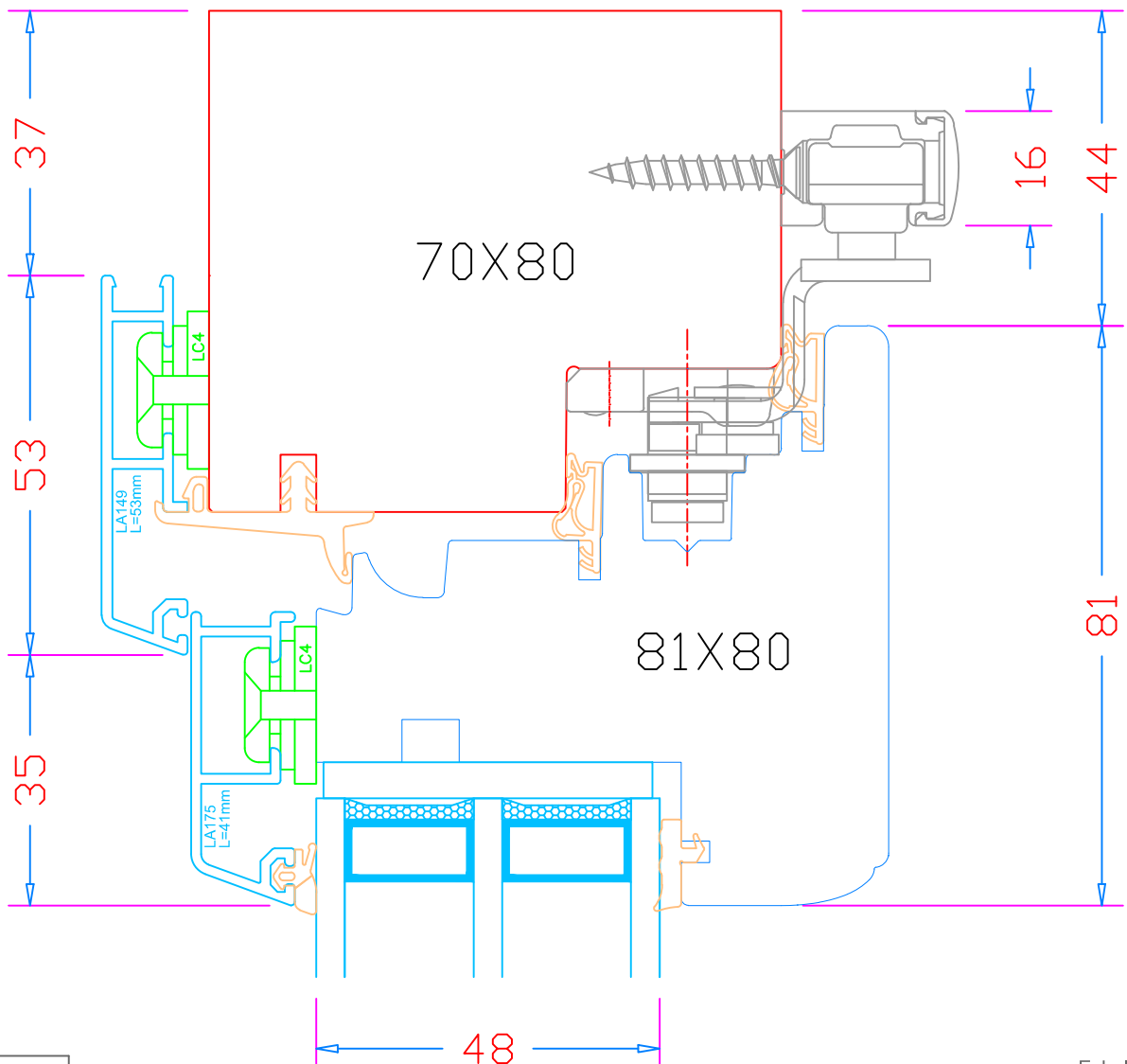
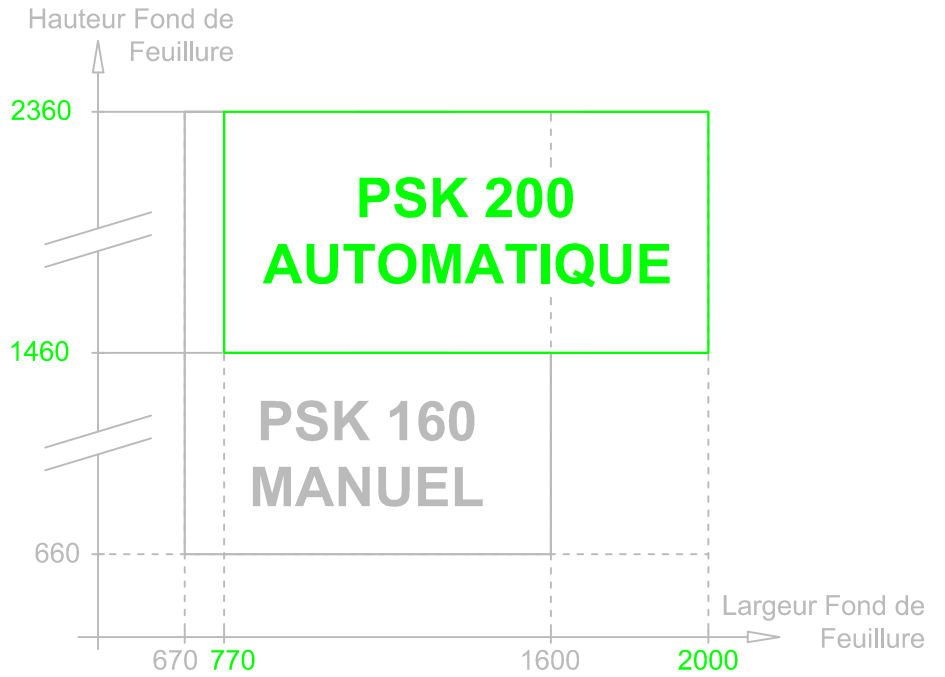
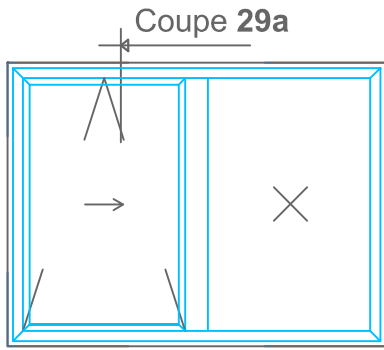

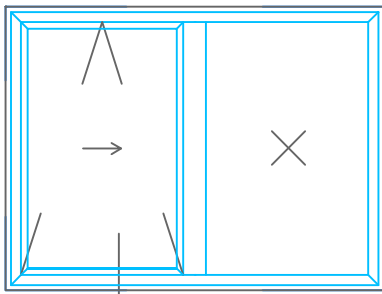

Coupe 29b

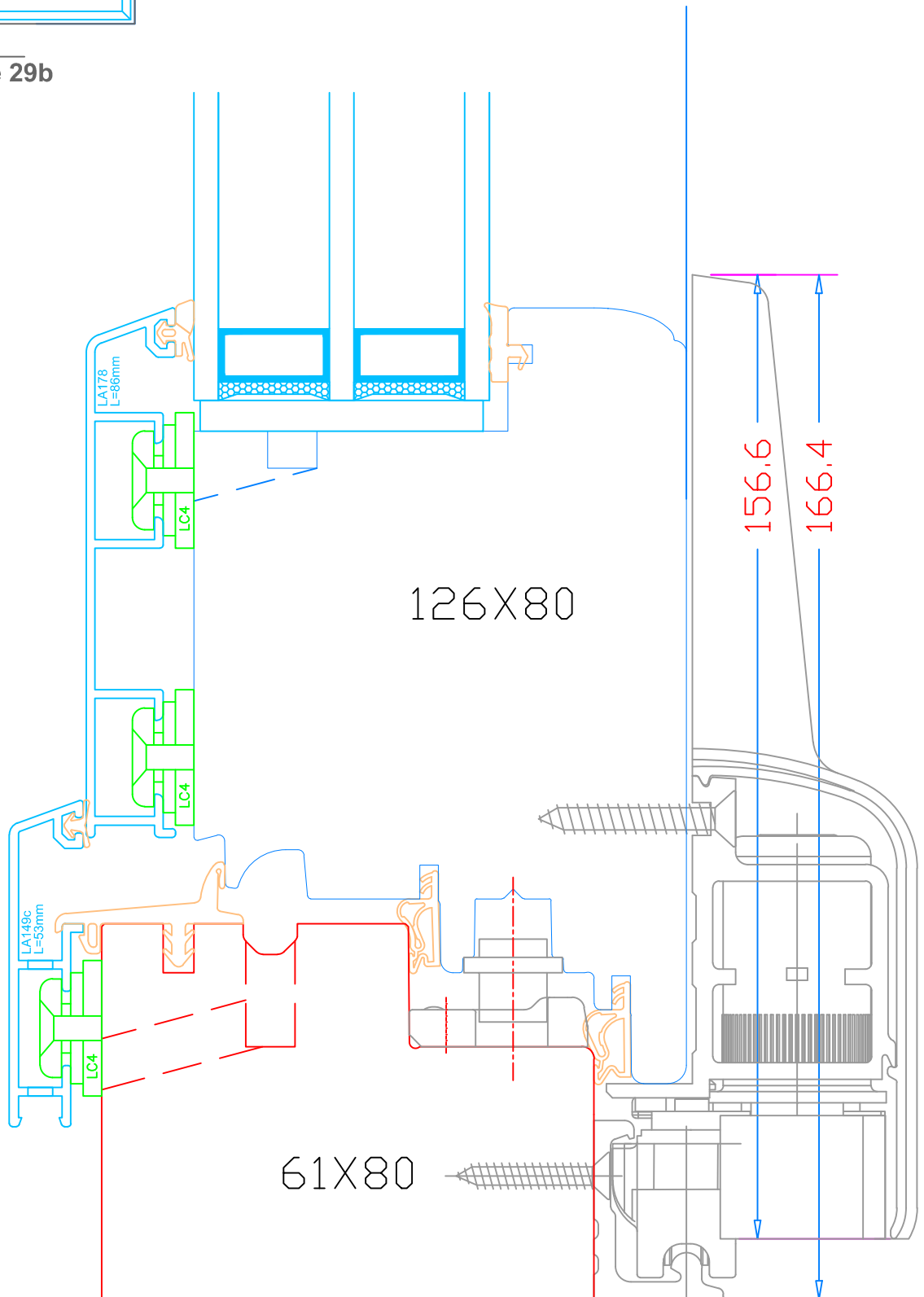

Date	17/10/2014
------	------------

Echelle : 1/1

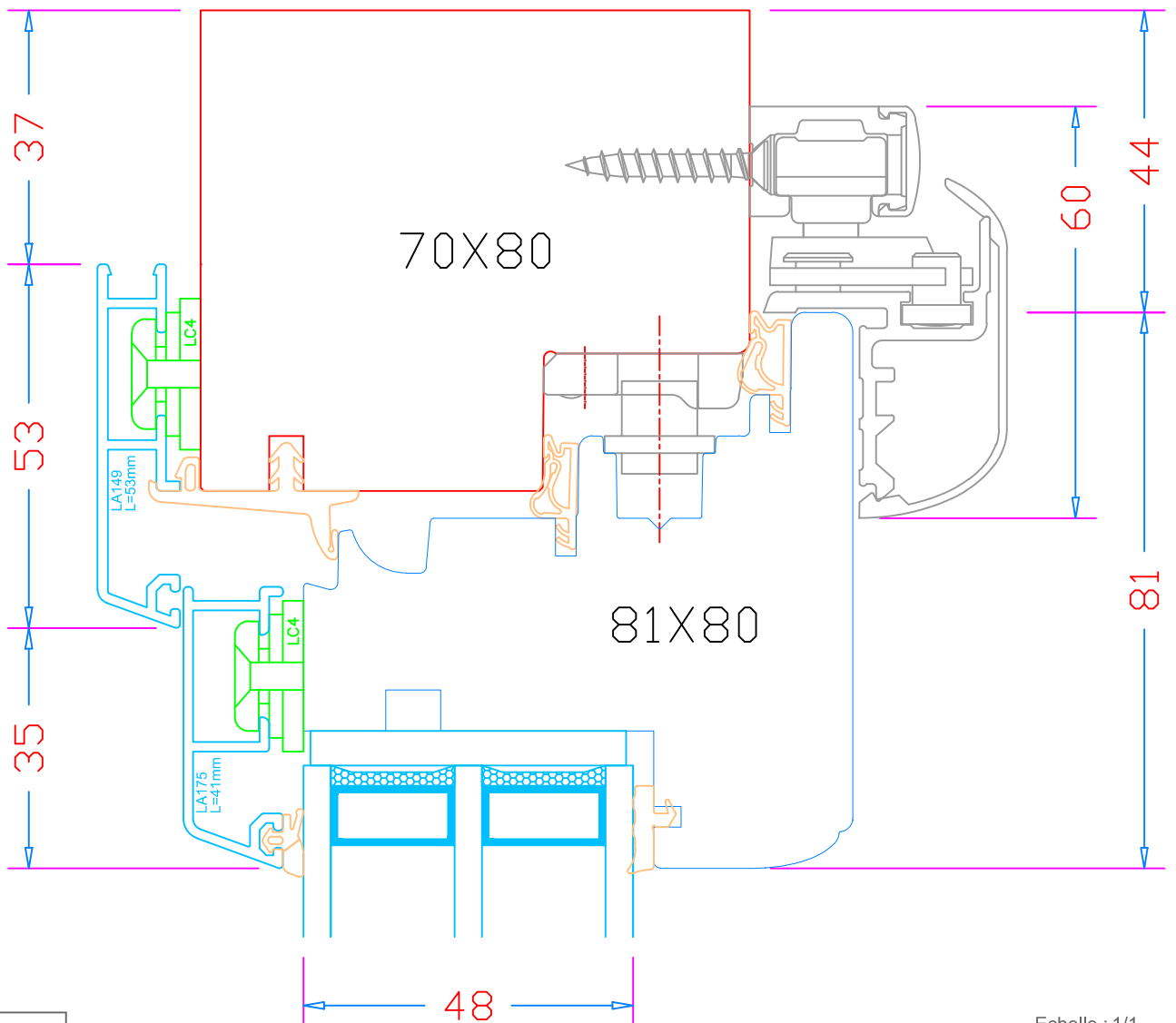
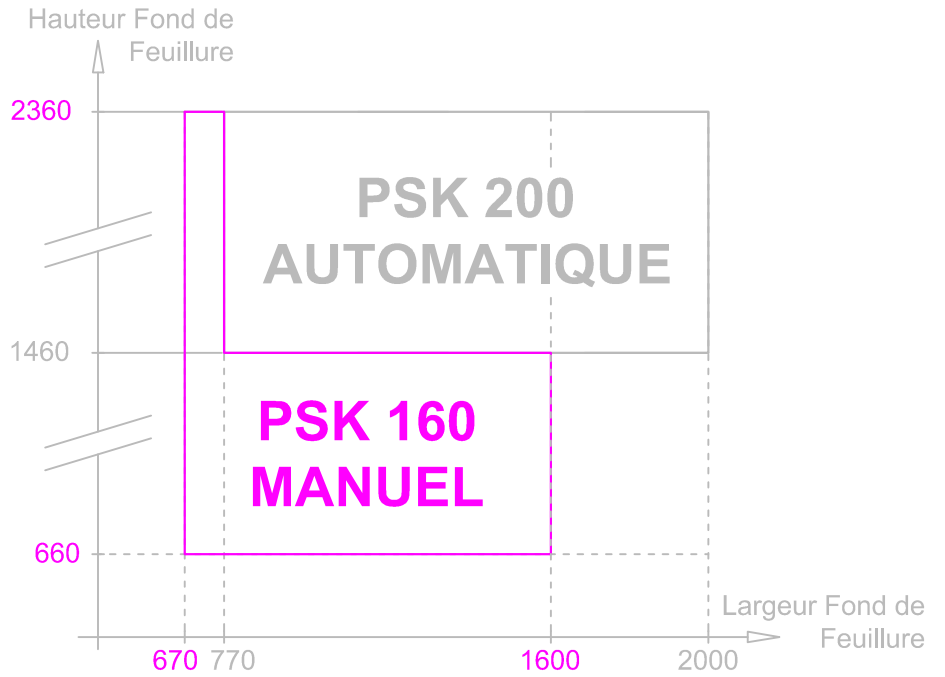
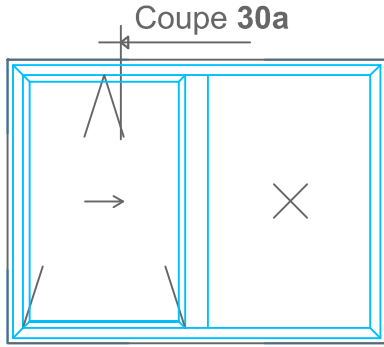

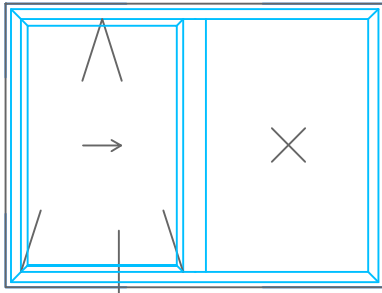

Coupe 30b

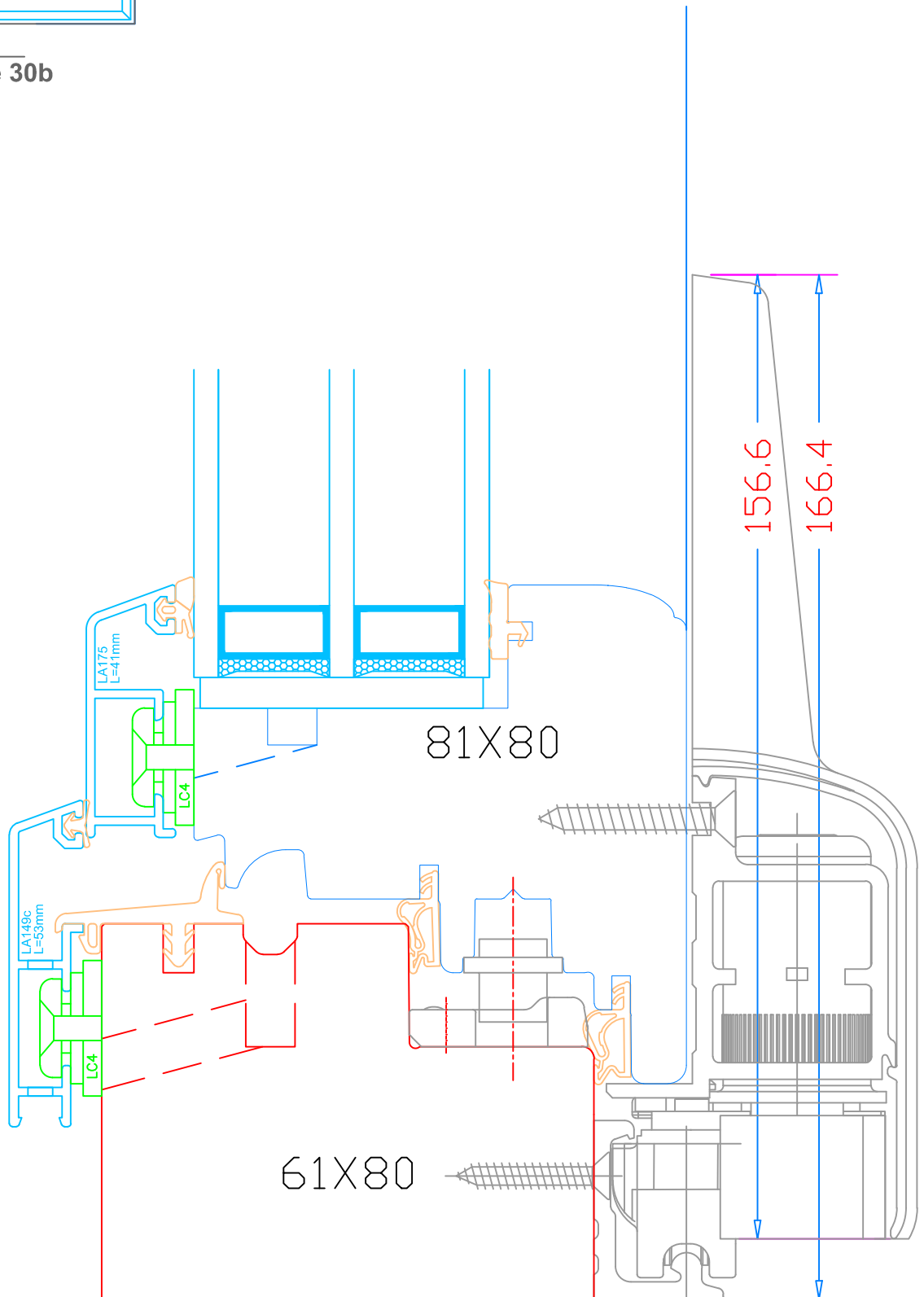

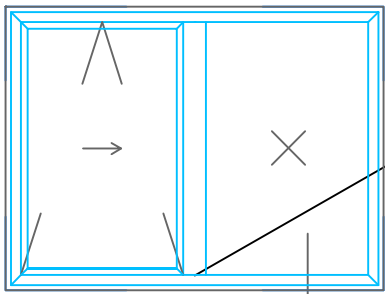

Coupe 31

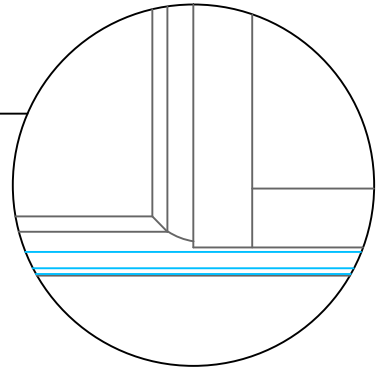

Vue intérieure
 Assemblage du meneau

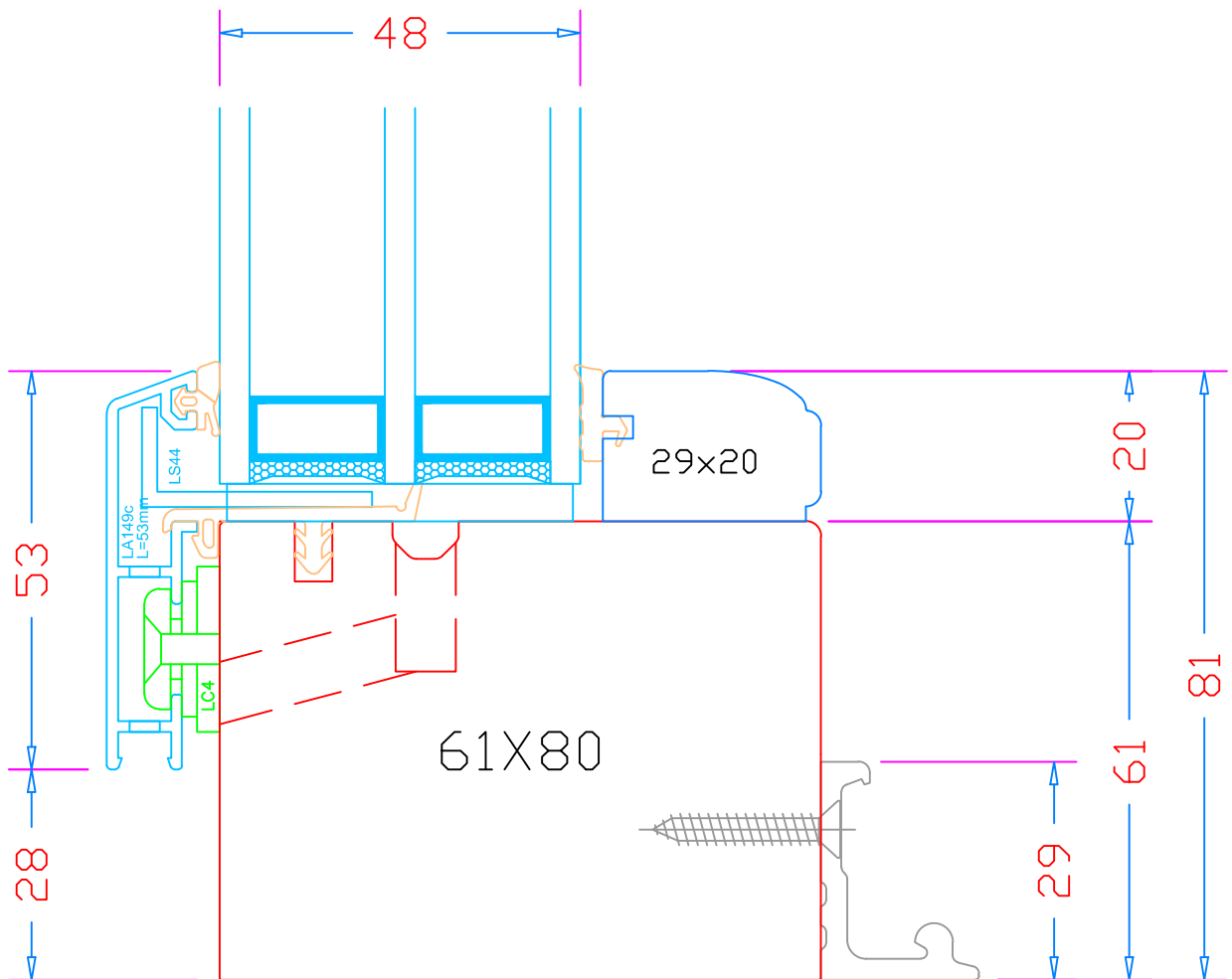

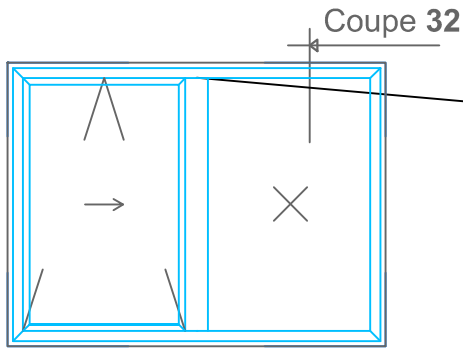

Vue intérieure
 Assemblage du meneau

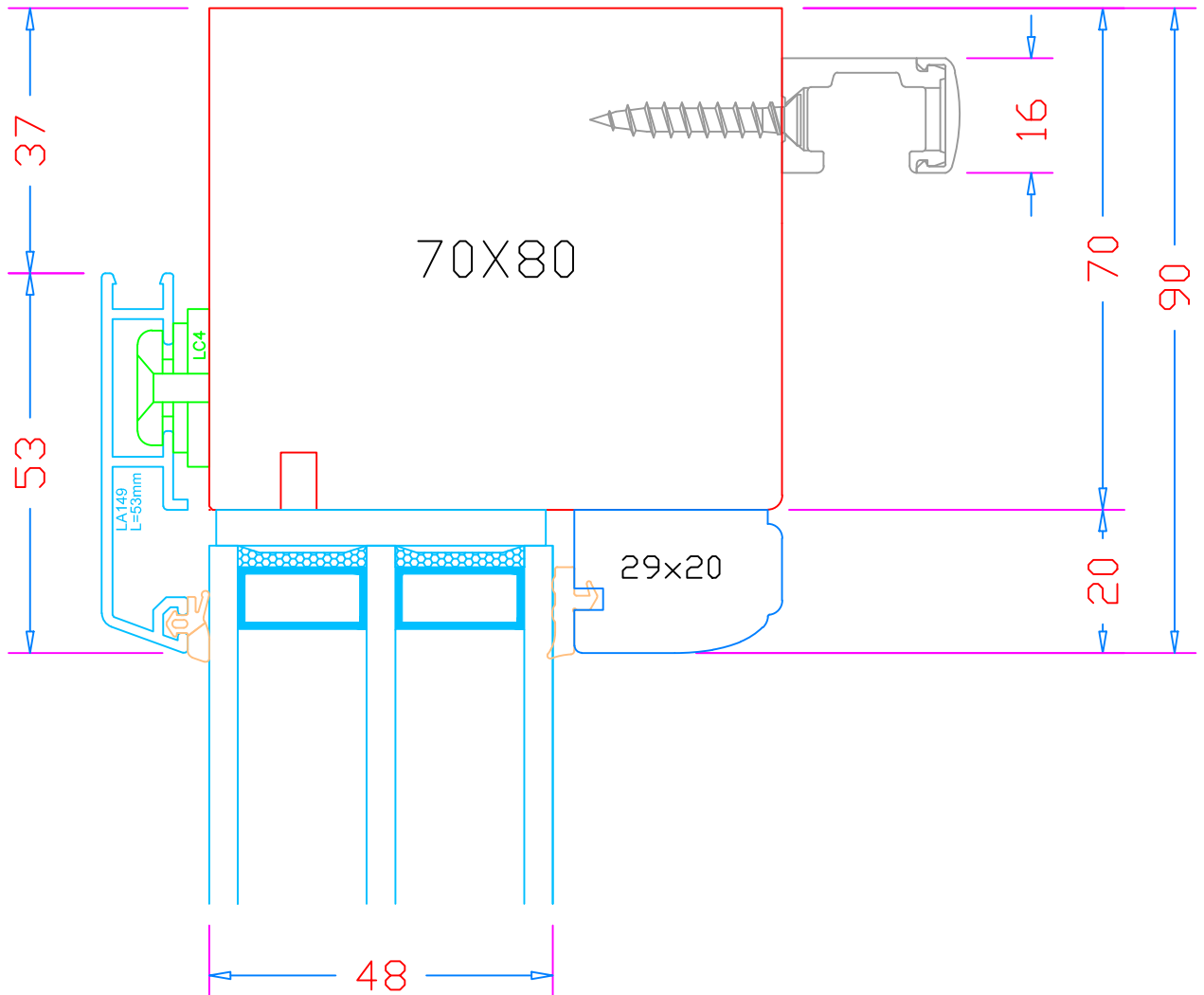
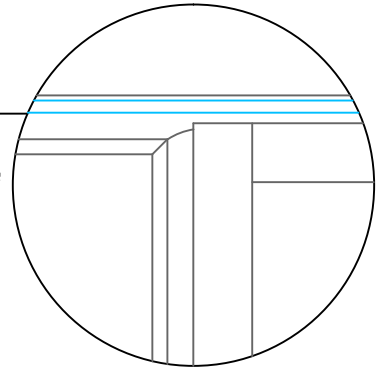

Coupe 33

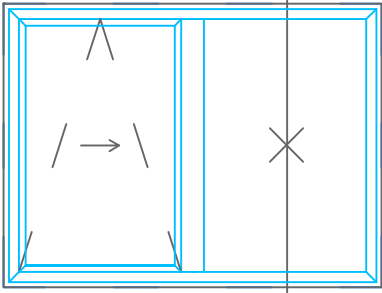

SEMI-FIXE



Attention, le coulissant basculant avec un semi-fixe est impossible dans la gamme UNI 9.

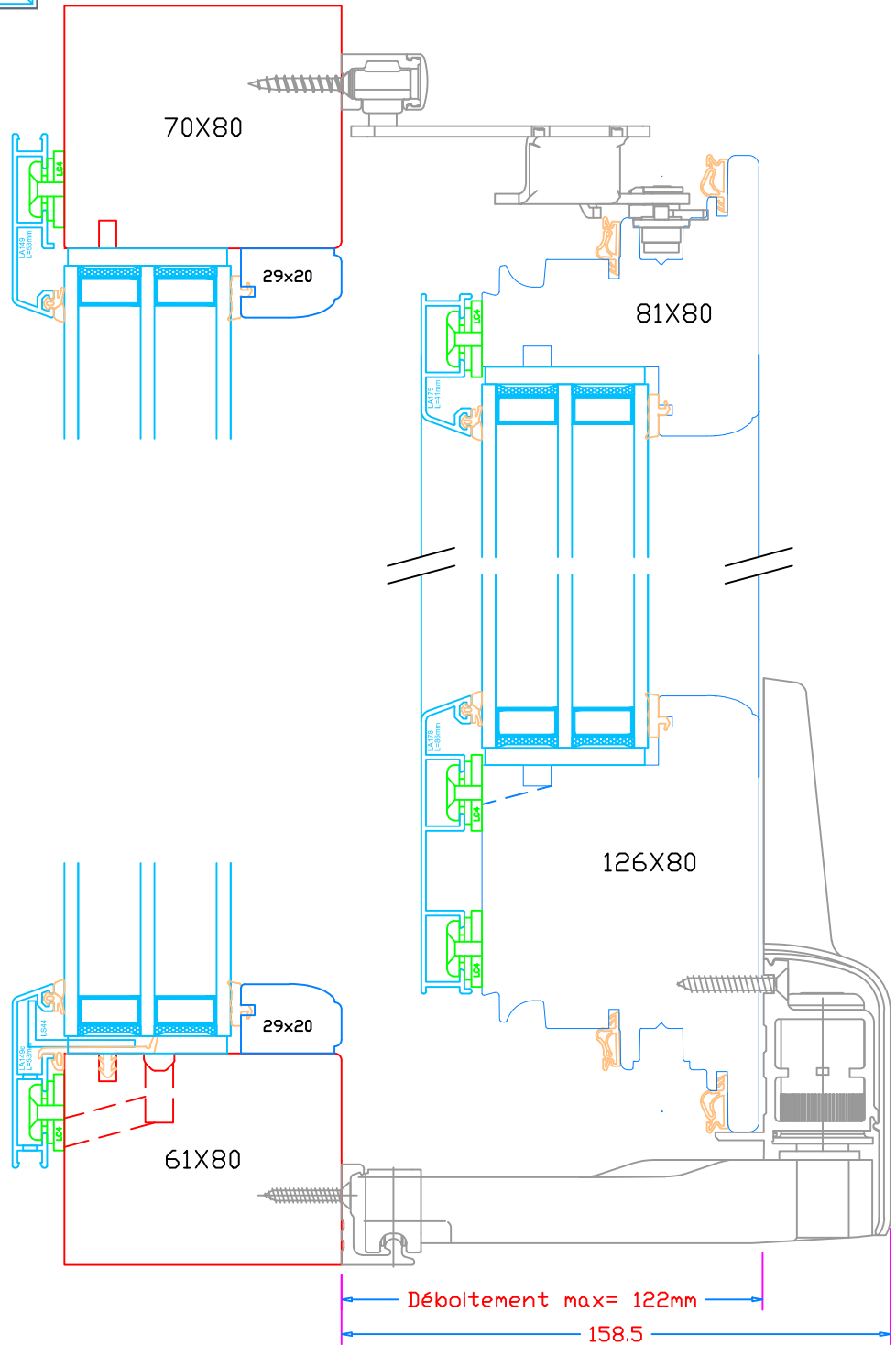

Coupes Ouverture Extérieure

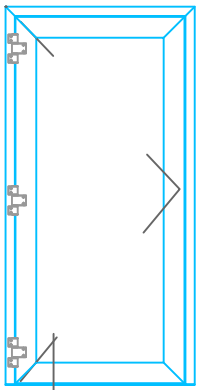

Coupe 34

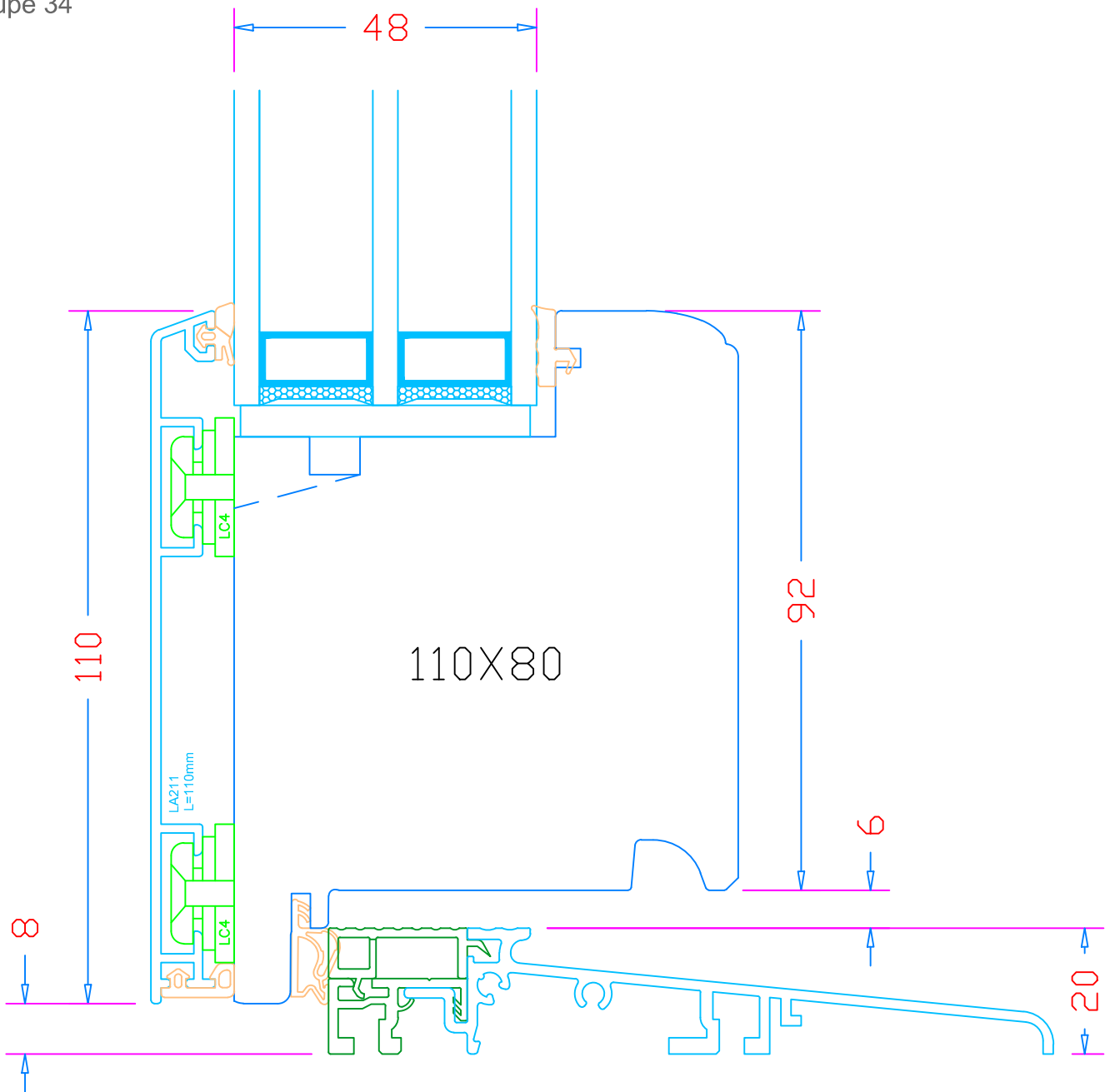

Coupe 35

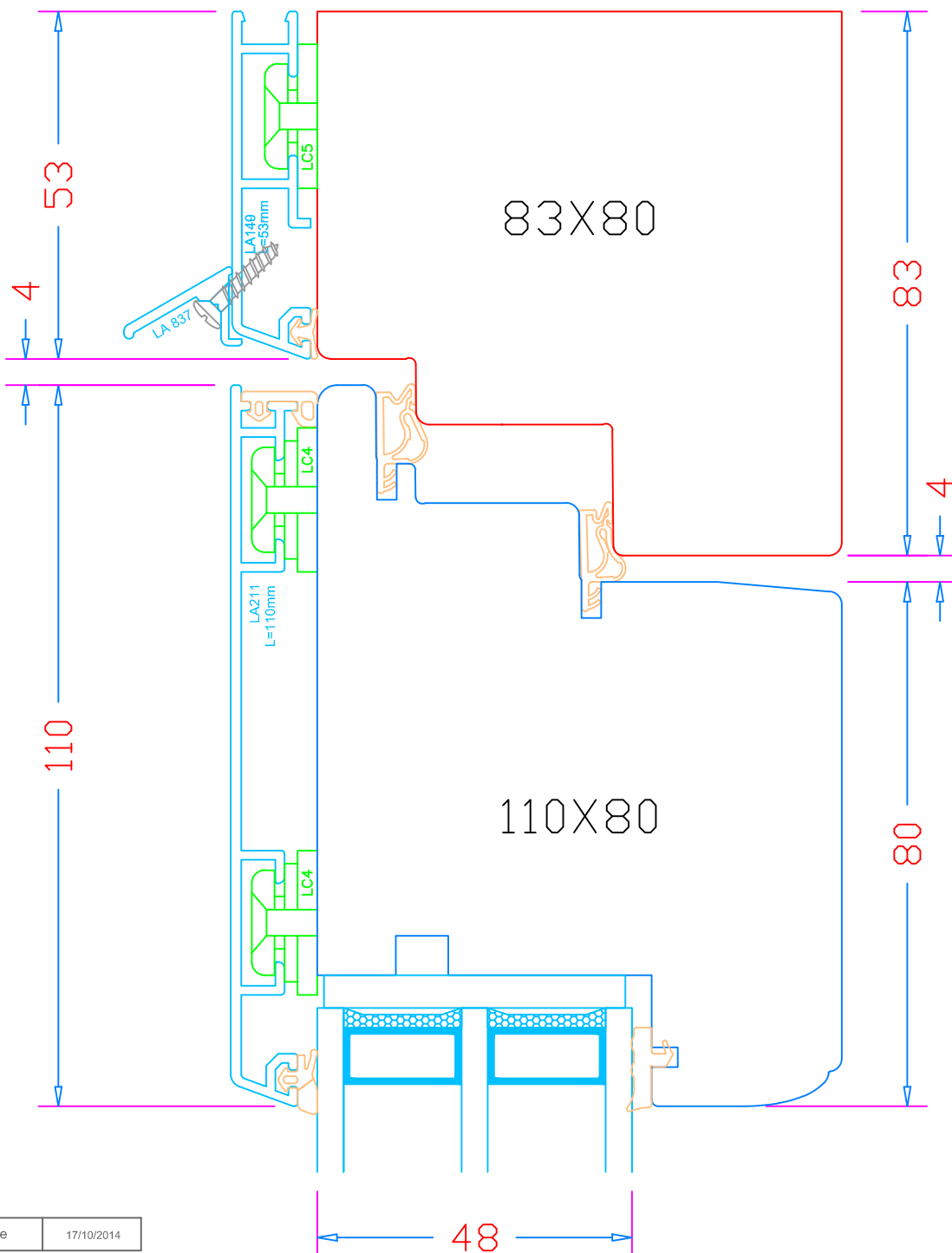
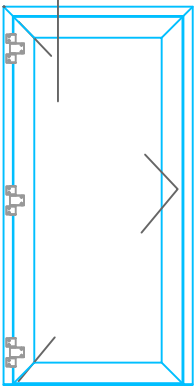

Date	17/10/2014
------	------------

Echelle : 1/1

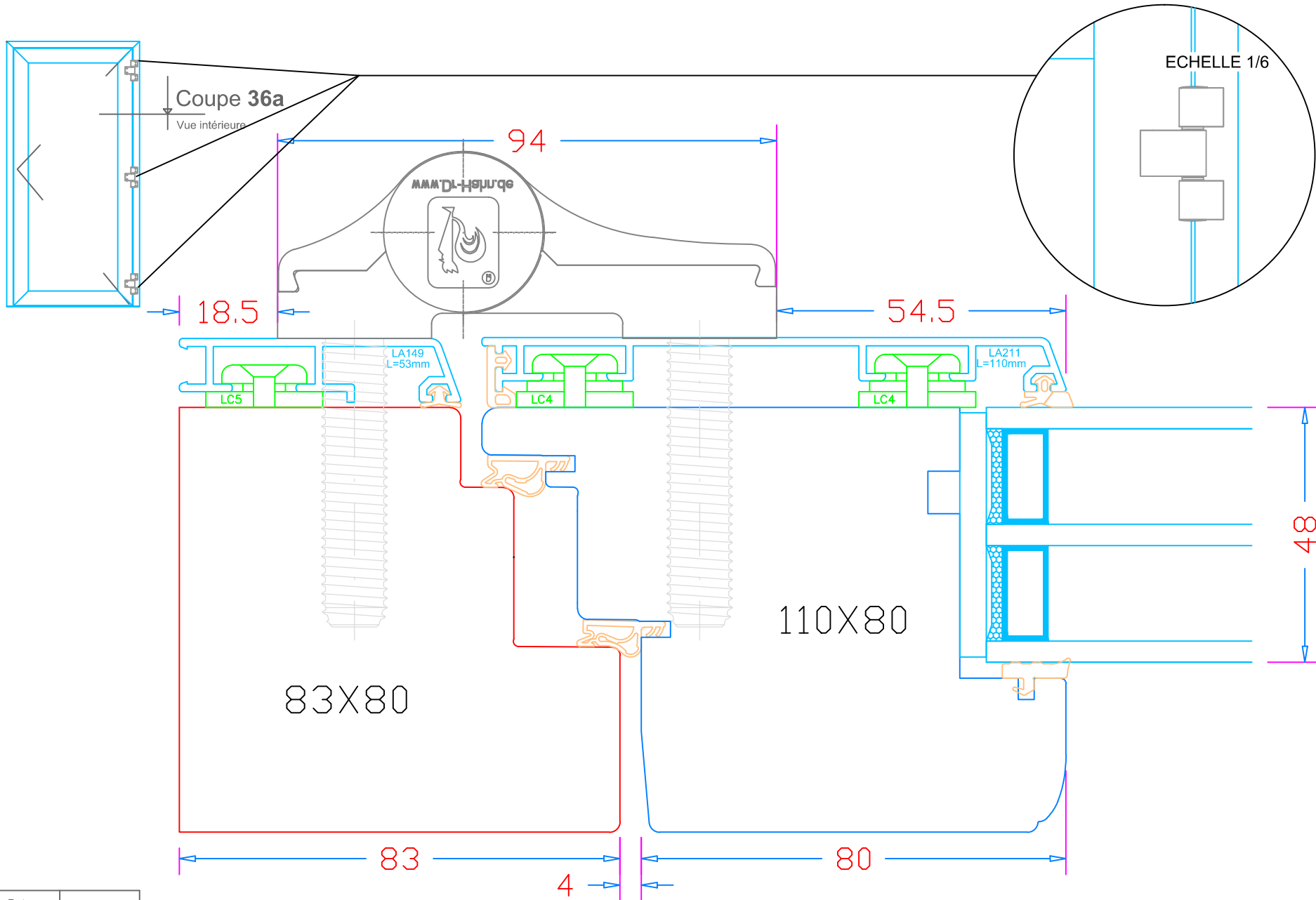

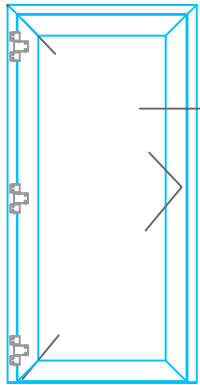

Coupe 36b
 Vue intérieure

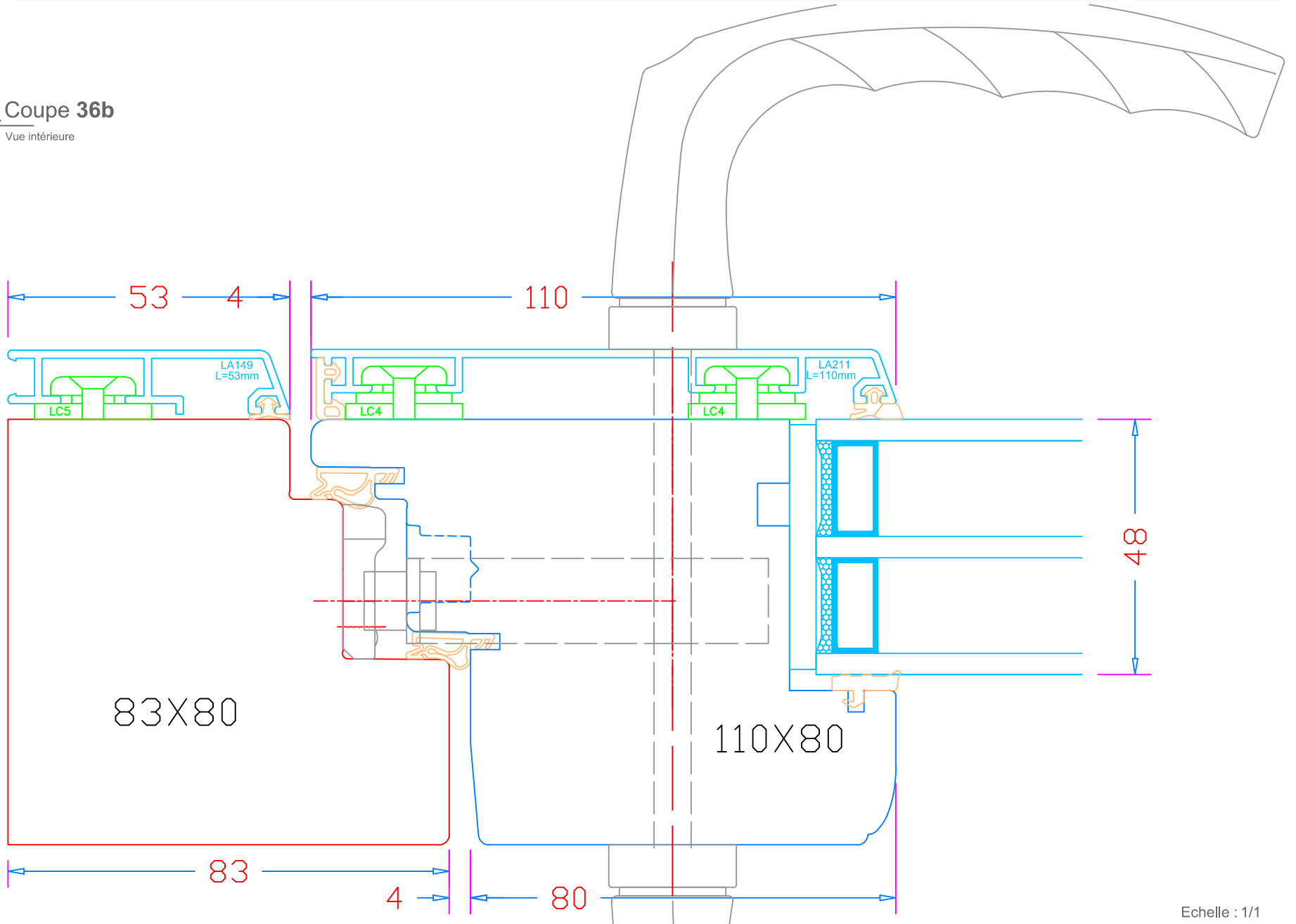

Coupe 37
Vue intérieure

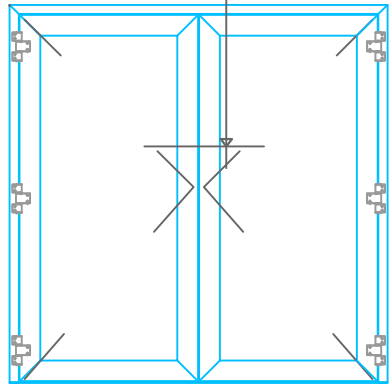

110

4

110

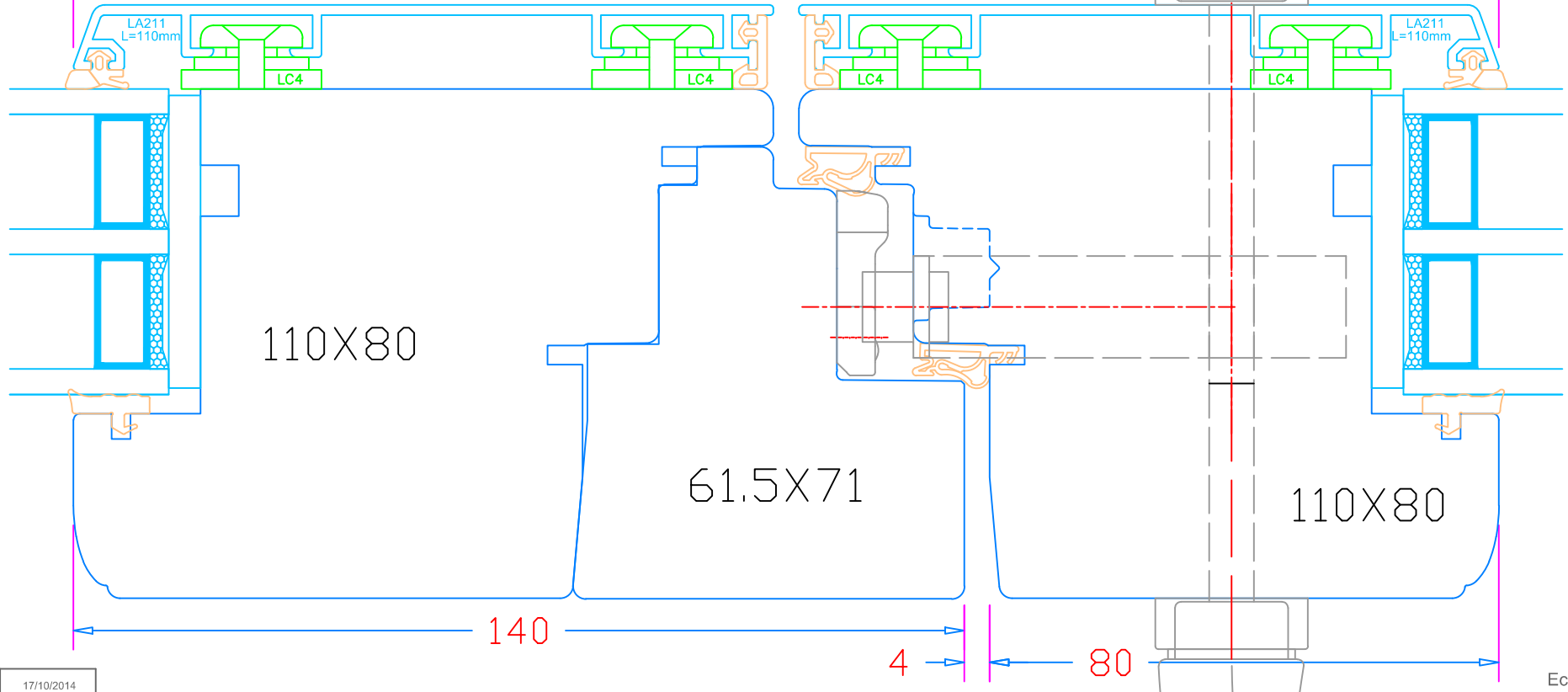

110X80

61.5X71

110X80

140

4

80

Date 17/10/2014

Echelle : 1/1

Mise en oeuvre de pose

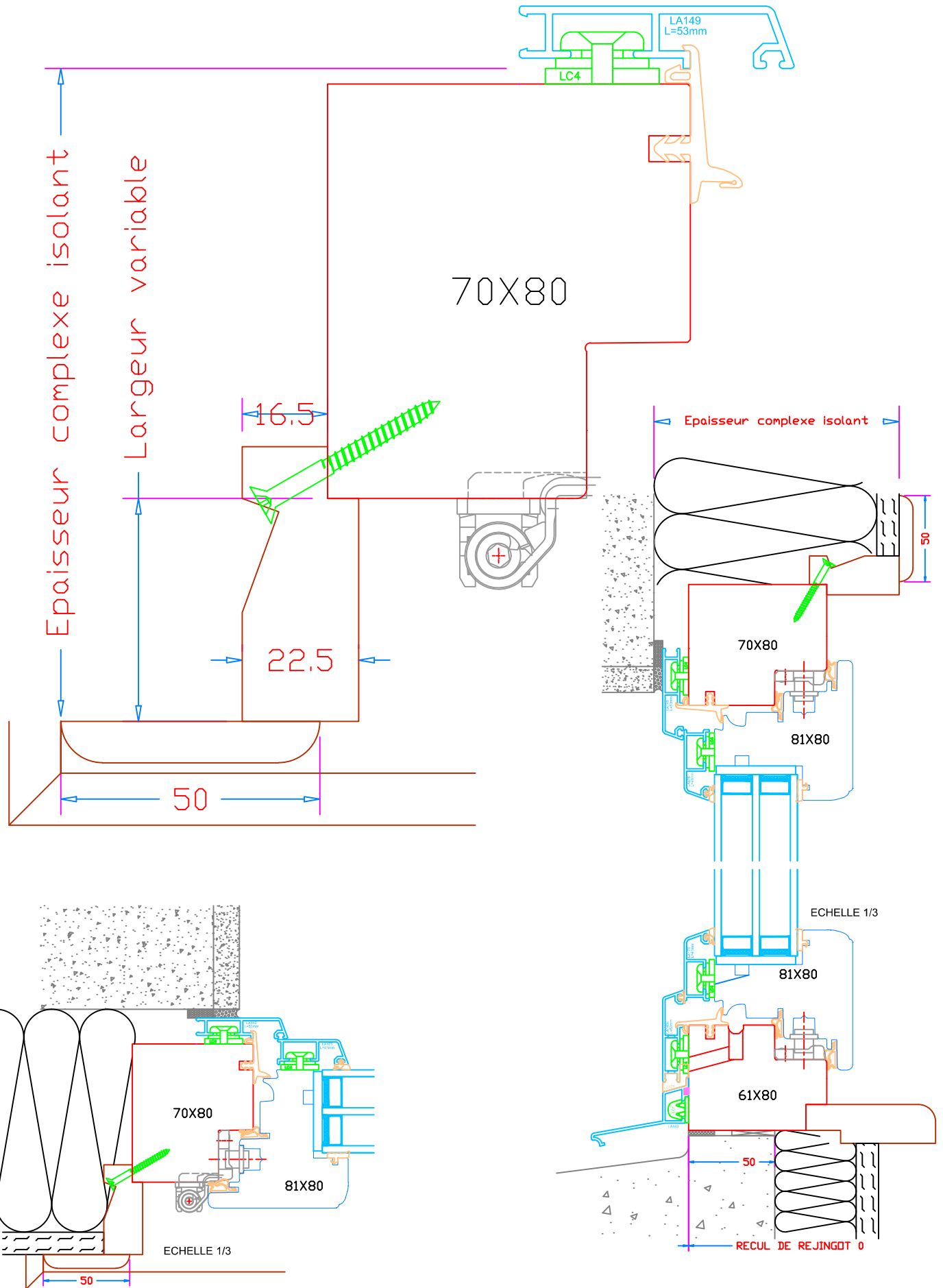

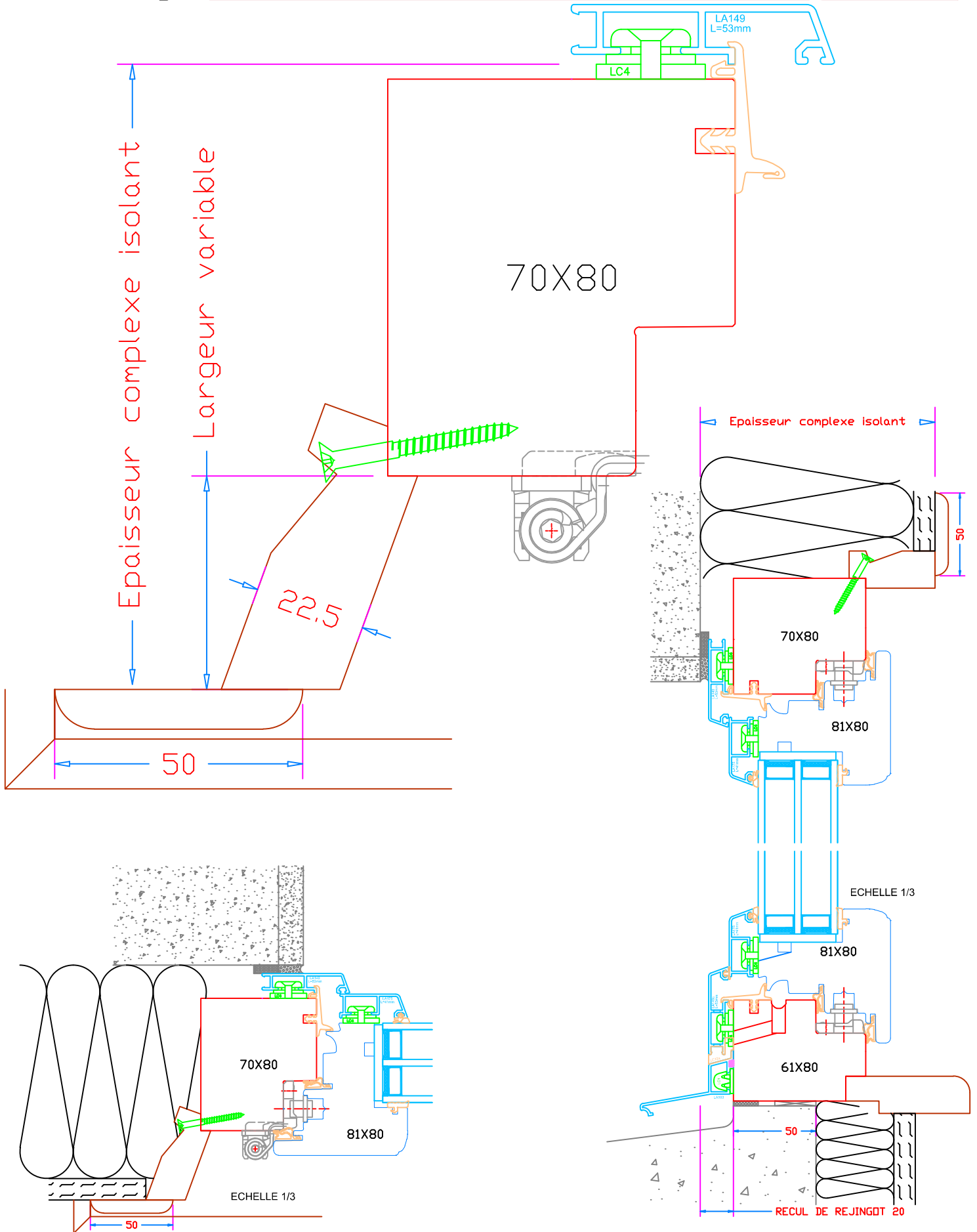

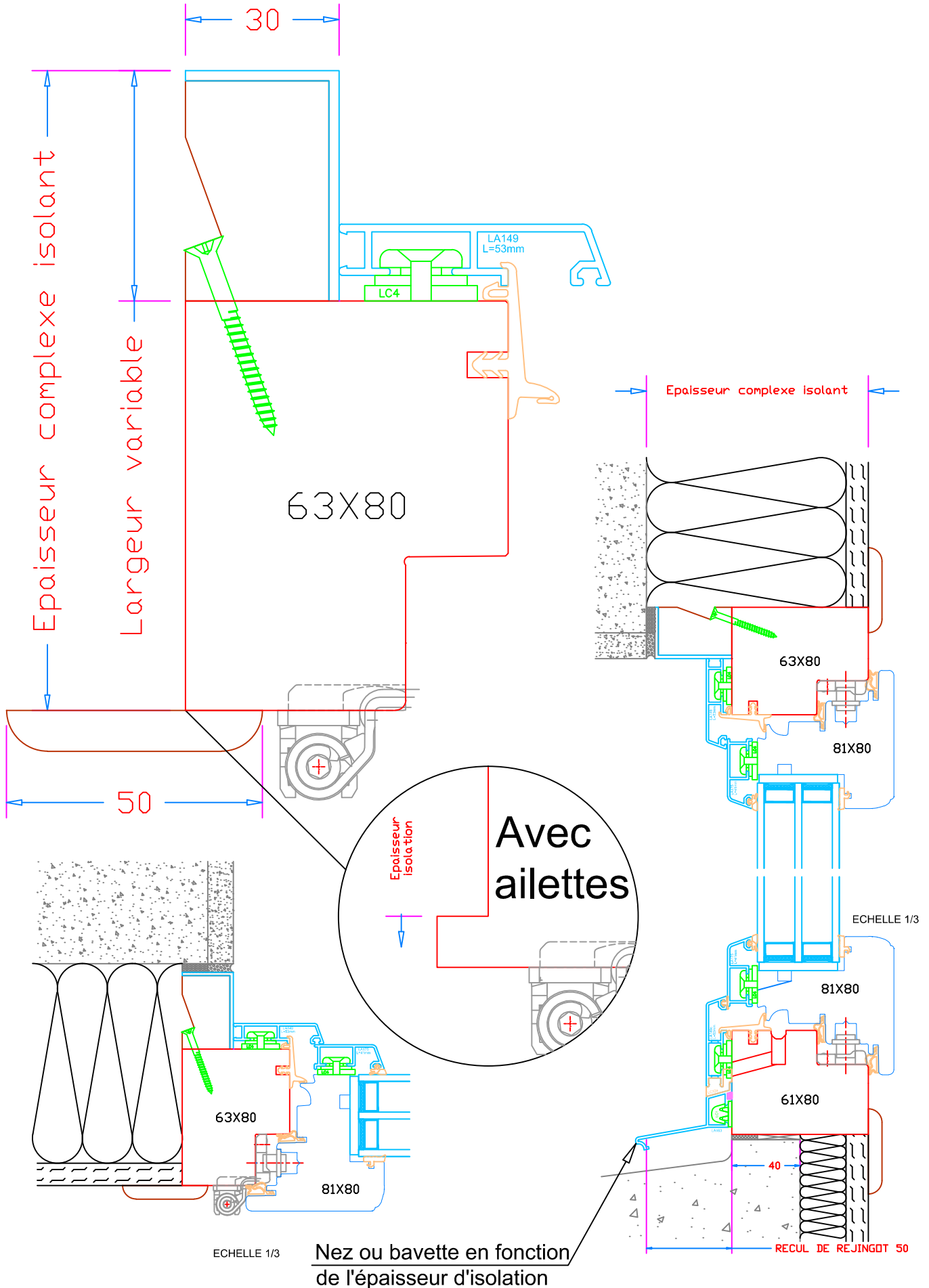

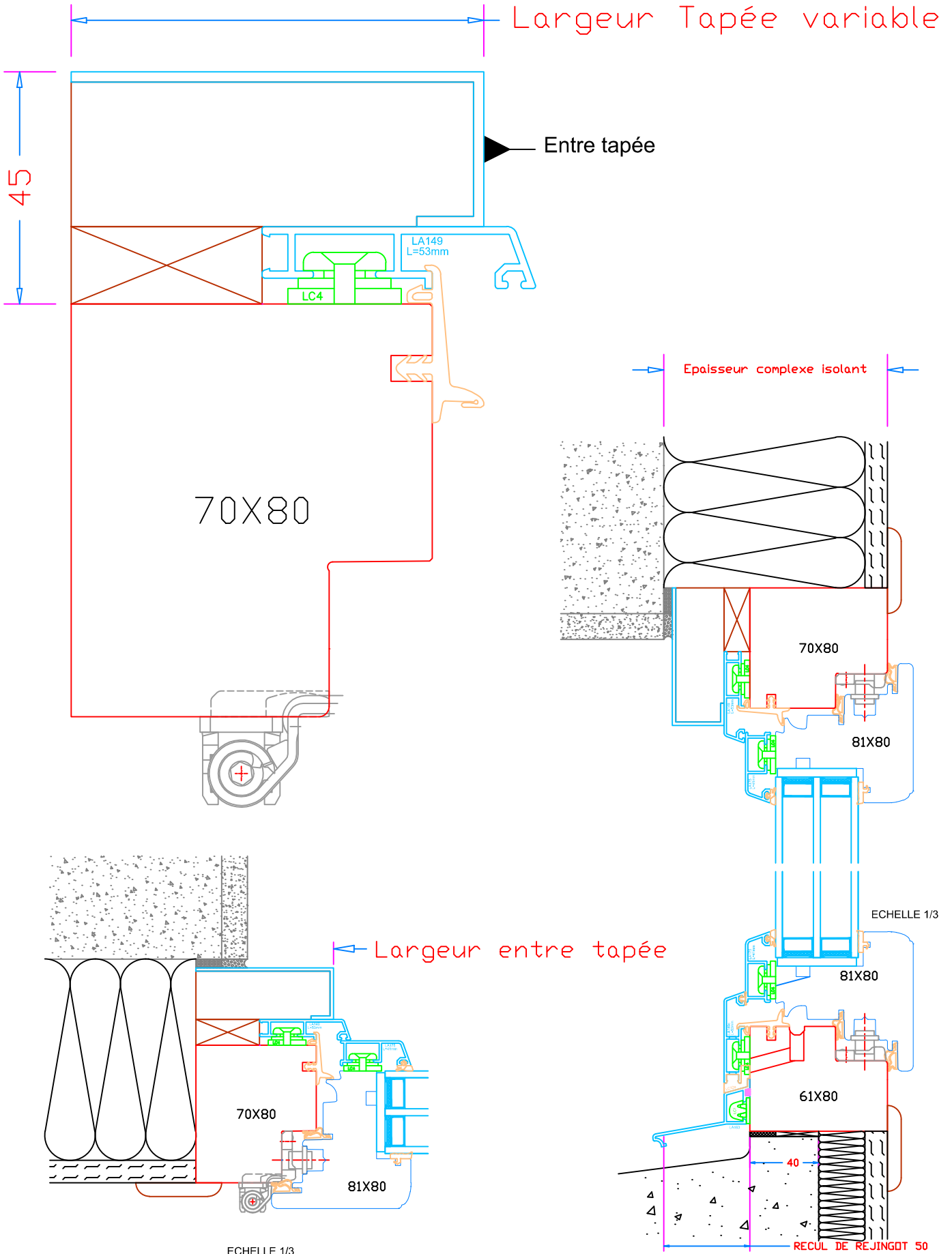

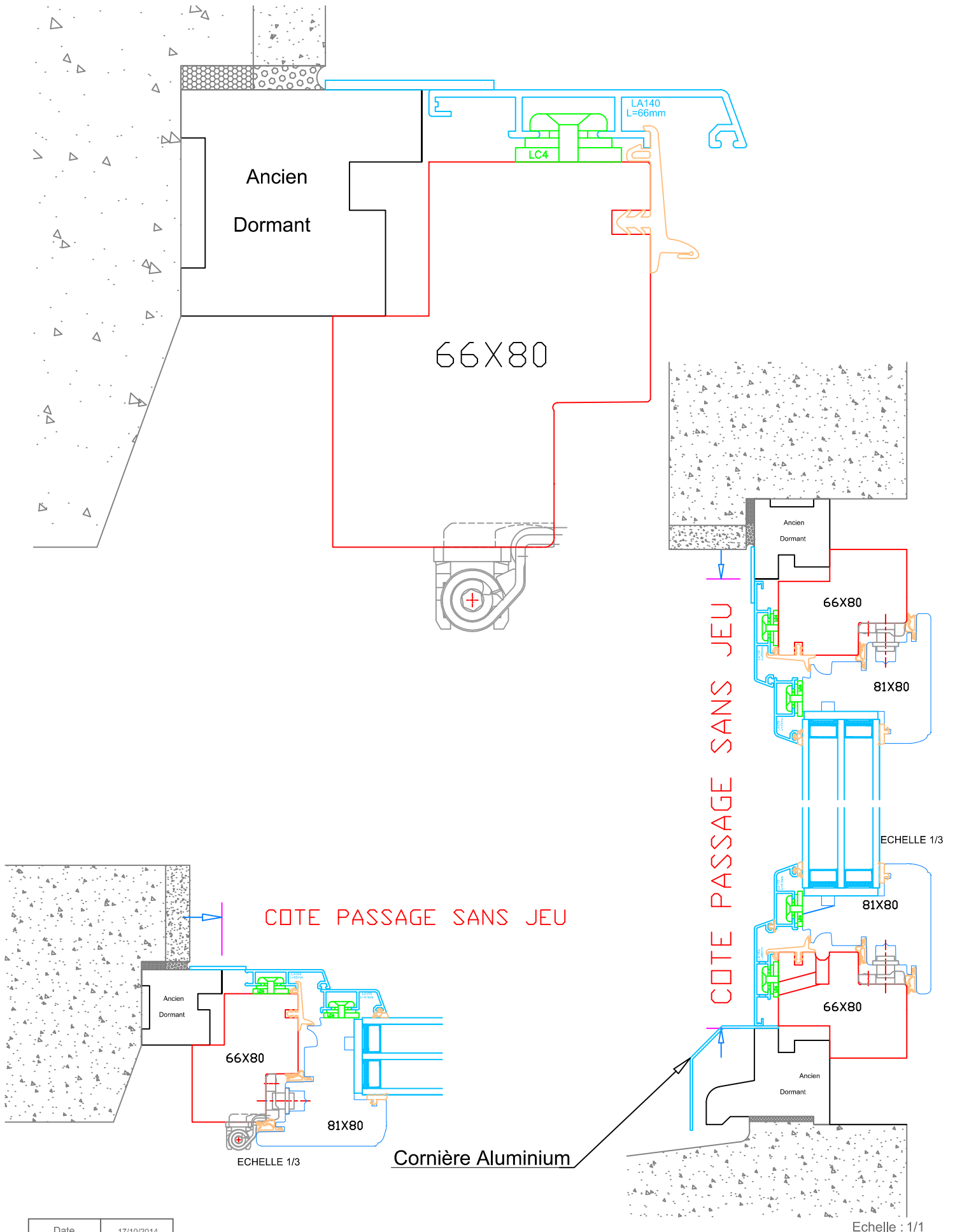

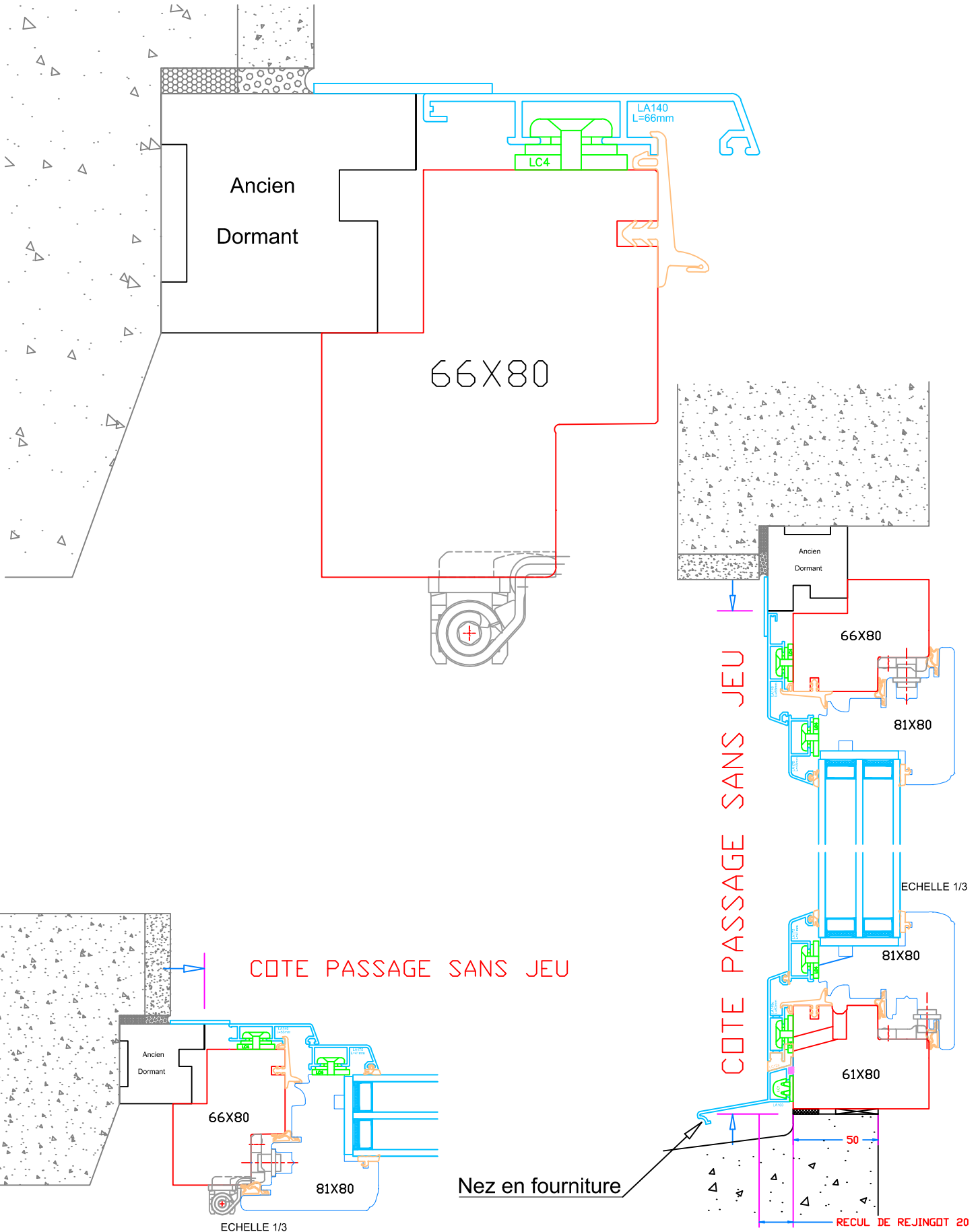

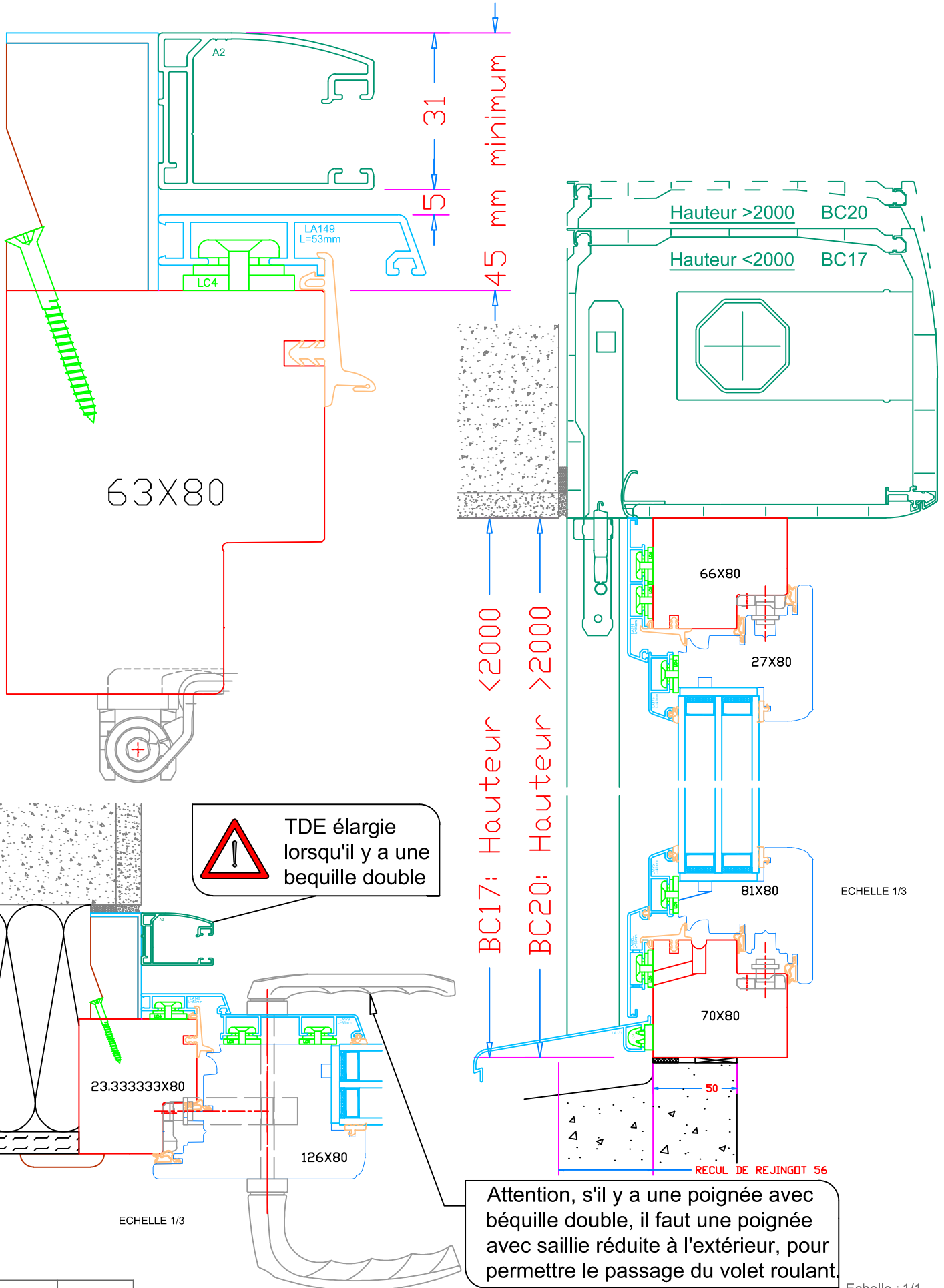

ECHELLE 1/3

ECHELLE 1/3

Attention, s'il y a une poignée avec béquille double, il faut une poignée avec saillie réduite à l'extérieur, pour permettre le passage du volet roulant.

Echelle : 1/1

Date	17/10/2014
------	------------

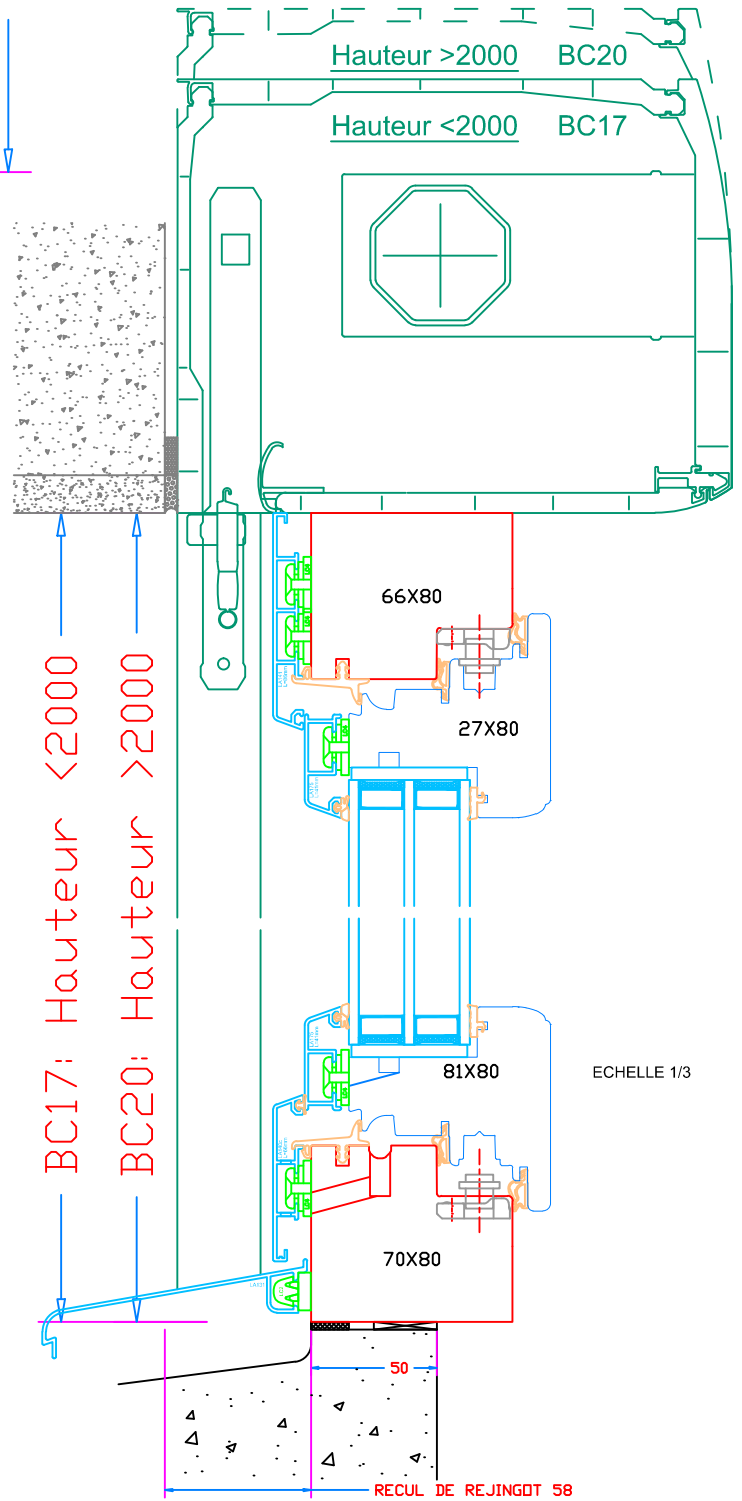
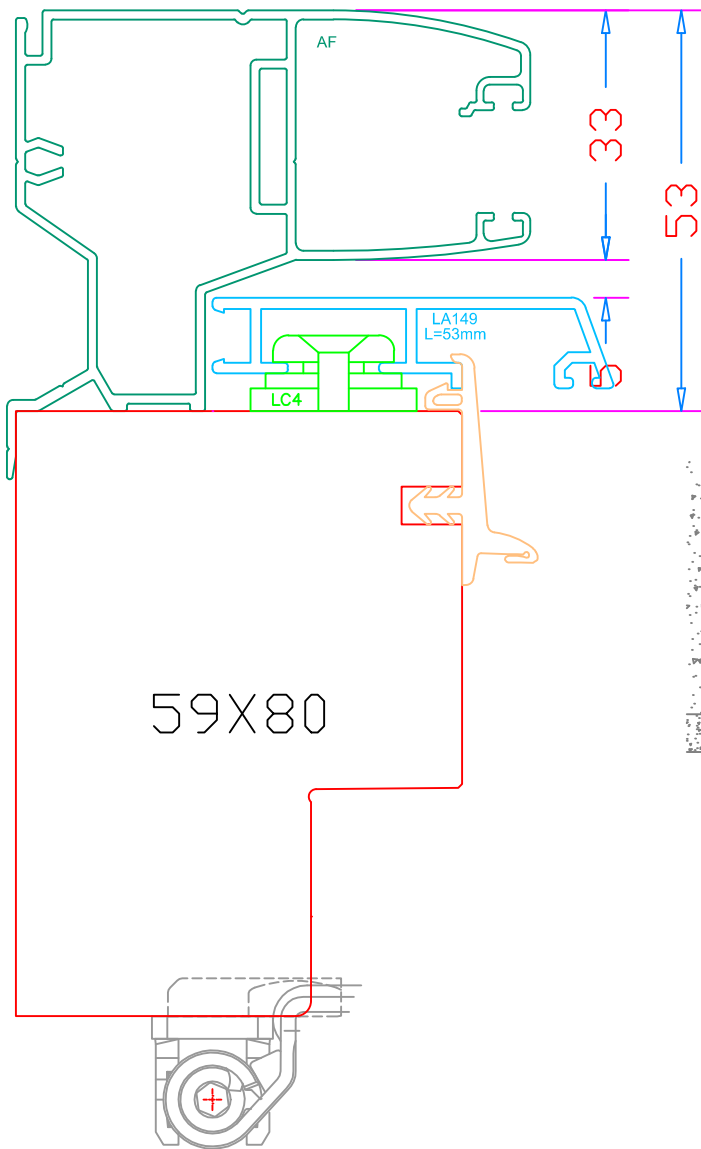

ECHELLE 1/3

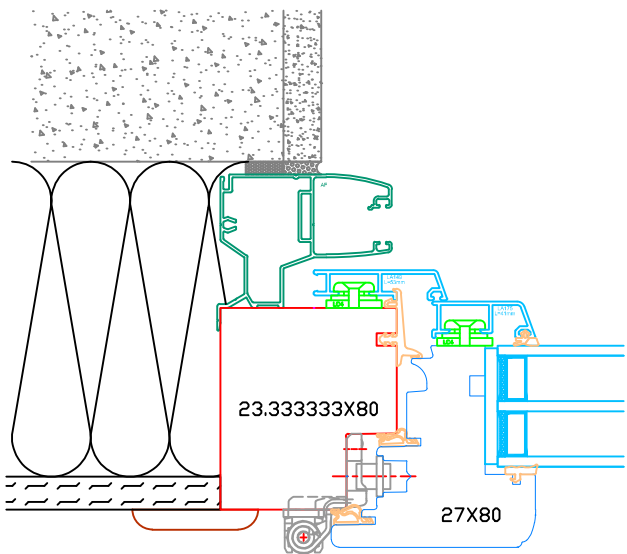

ECHELLE 1/3



Avec une béquille double, il faut utiliser la coulisse aluminium A2

Date 17/10/2014

Echelle : 1/1

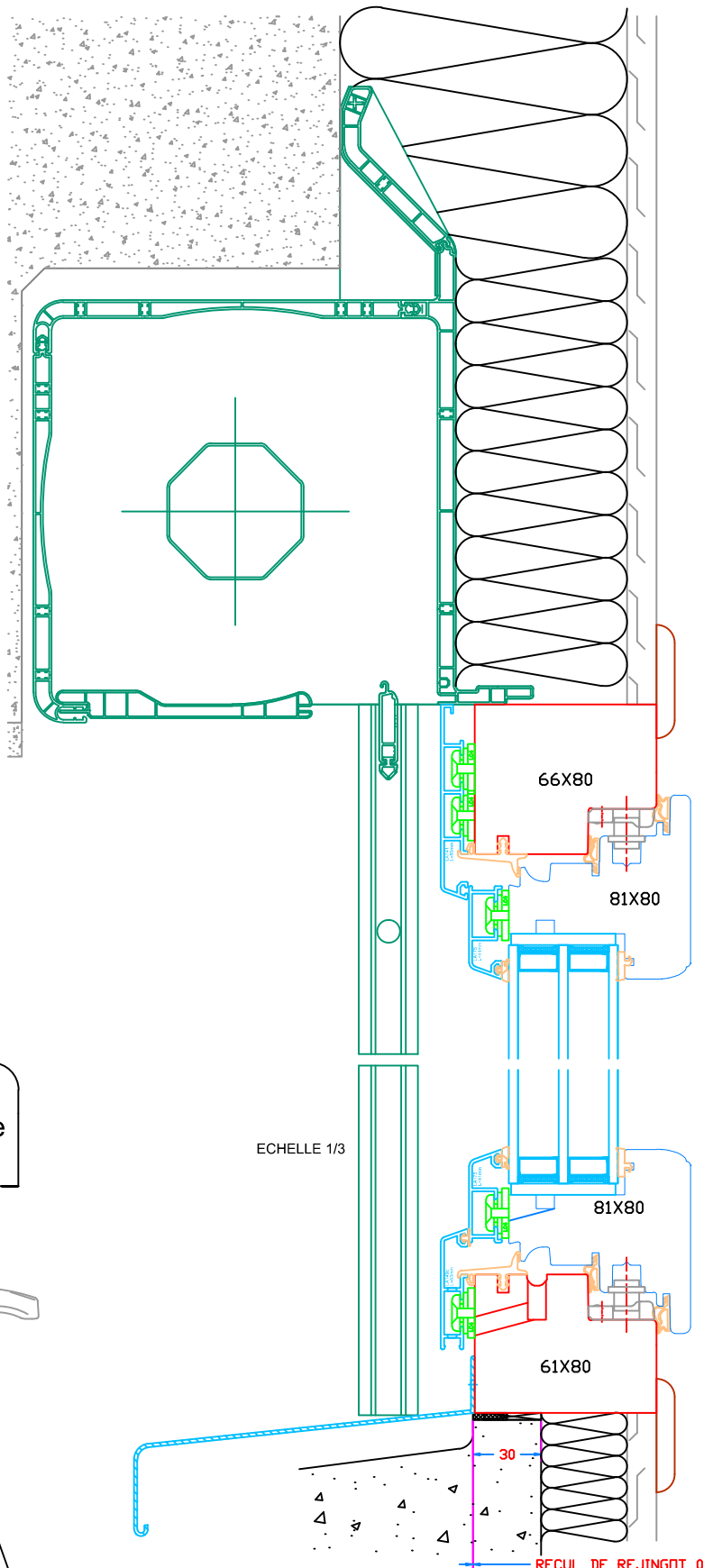
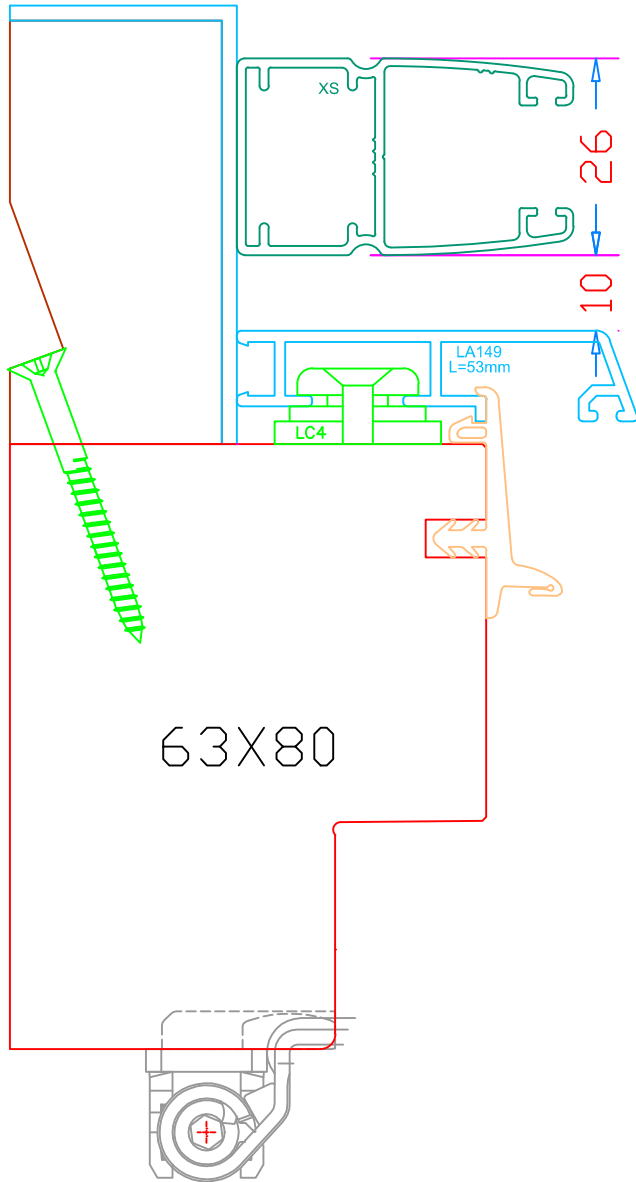

 TDE élargie lorsqu'il y a une bequille double

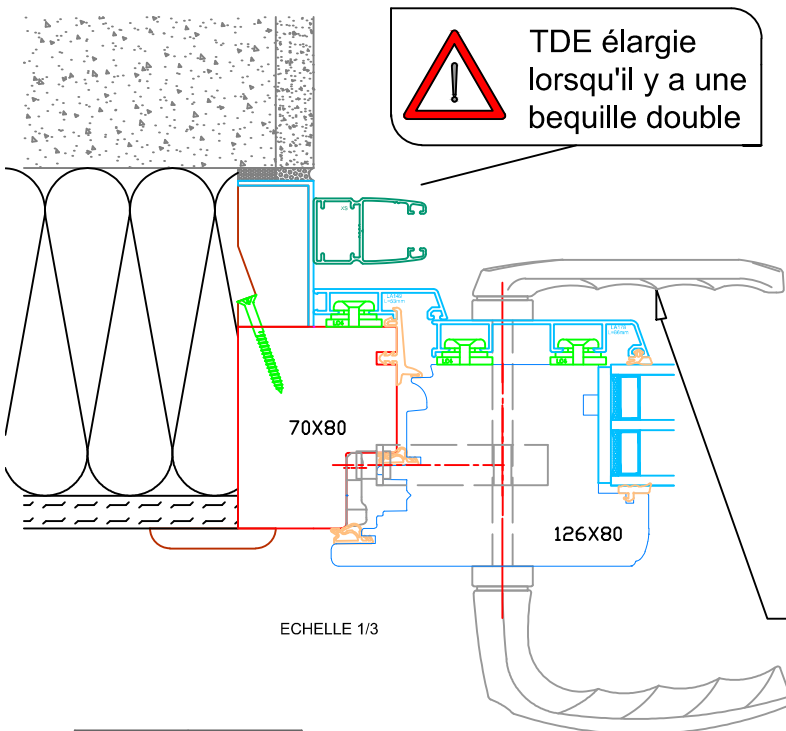

Attention, s'il y a une poignée avec bequille double, il faut une poignée avec saillie réduite à l'extérieur, pour permettre le passage du volet roulant.

